

SHOP PRACTICE  
FOR  
HOME MECHANICS

---

YATES



Class TT 155

Book .Y3

Copyright N<sup>o</sup> \_\_\_\_\_

**COPYRIGHT DEPOSIT.**





# SHOP PRACTICE FOR HOME MECHANICS

Use of Tools                      Shop Processes  
Construction of Small Machines

AN INDISPENSABLE BOOK FOR ALL INTERESTED IN MECHANICAL WORK. GIVING PRACTICAL AND USEFUL INFORMATION CONCERNING THE VARIOUS PHASES OF WORK THAT ARE INCLUDED IN AMATEUR MECHANICS, SUCH AS THE USE OF MISCELLANEOUS TOOLS, DRILLING AND REAMING, LATHE WORK, PATTERN MAKING, HARDENING AND TEMPERING OF STEEL, SOLDERING AND BRAZING AND MACHINE CONSTRUCTION

CONTAINS A CHAPTER ALSO ON  
THEORETICAL MECHANICS AND ON MISCELLANEOUS INFORMATION RELATIVE TO SHOP WORK

By **RAYMOND FRANCIS YATES**

AUTHOR OF "MODEL MAKING," "HOW TO MAKE AND USE A SMALL CHEMICAL LABORATORY," "LATHE WORK FOR BEGINNERS," "SOLDERING AND BRAZING," ETC.



*FULLY ILLUSTRATED WITH 309 ENGRAVINGS*

NEW YORK  
THE NORMAN W. HENLEY PUBLISHING COMPANY  
2 WEST 45TH STREET  
1920

TT155  
Y3

COPYRIGHT, 1920, BY  
THE NORMAN W. HENLEY PUBLISHING COMPANY  
—  
ALL RIGHTS RESERVED

PRINTED IN U. S. A.

©Cl. A 571988

AUG -5 1920

## PREFACE

Long before the author was asked to prepare this volume on shop practice for home mechanics, he had a well-formed conception of just what such a book ought to cover and how the subject-matter ought to be presented. Having started to dabble in amateur mechanics at the tender age of fourteen, he often found himself in dire need of some handy reference on shop processes—processes that could be employed about the small shop without elaborate equipment and great expense. Peculiar enough there has been no book, to the writer's knowledge, that covers this field. It was this fact that caused him to think so much about the preparations of such a book before the opportunity to write it actually presented itself.

An examination of the current volumes concerning shop practice reveals nothing of real worth to the amateur; they ignore his little problems and trials that he meets in the routine of his small shop. The information relates to large, costly machines and appliances. The real amateur has little use for data concerning turret lathes, cylindrical grinders and broaching machines. He is, however, generally hungry for information that will help him to do better work in the easiest and best way.

A word about the subject-matter. It has been arranged progressively so that the beginner can study the book just as he would study a book on elementary chemistry. The first chapter, although theoretical in its aspect, has a distinct relationship to elementary mechanics, and the

reader is advised to give it careful attention. It deals with those great fundamentals upon which the whole science of mechanics rests. The following chapters treat simple shop operations and the use of small tools. The lathe is covered in detail as this is the most important tool in the shop, without which little can be done in the way of serious work. Such operations as grinding, hardening and tempering steel, pattern making, soldering, etc., are included, as the amateur must be proficient in all of these branches of his work. The last chapter contains such information and data as the author felt could be used advantageously in general shop routine. Some of the matter contained in this chapter was suggested by questions asked by the readers of *Everyday Engineering Magazine*, which the author, as editor of this journal, was called upon to answer.

The author wishes to have the readers know that he is indebted to Mr. R. H. Wagner for the splendid design of the small brass smelting furnace described in Chapter IX; also to Mr. Homer Trecartin for reliable data on gears, and to his friend and counsellor, Mr. Dwight S. Simpson, for the useful table on A. S. M. E. thread standards.

It is hoped that this work will merit the approval of that multitude of amateur mechanics in America who work diligently in their little shops for no other reason than an unquenchable desire to "make things."

RAYMOND FRANCIS YATES.

June, 1920



# CONTENTS

## CHAPTER I

### INTRODUCTION TO THE STUDY OF ELEMENTARY MECHANICS

The three states of matter—Energy—Power—Work—Force—Application of force to matter—The lever—Pulleys—Inclined plane—The wedge—The screw—Friction—Lubrication—Gravity—Momentum—Mass—Velocity—Gears—Gear problems—How to figure for gear strength—Calculation of power—Strength of gears—Gear tables—Gear speeds—Coefficient of cubical expansion—Coefficient of linear expansion—Apparatus to indicate linear expansion—Apparatus to indicate cubical expansion—How to figure linear expansion .....Pages 15-47

## CHAPTER II

### THE USE OF MISCELLANEOUS TOOLS

Different kinds of hammers—Choice of hammers—Files—Choice of files—Classification of files—Use of files—Flat filing—Draw filing—Round filing—Scrapers—How to make scrapers—Proper use of scrapers—Vises—The vise used as a press—Vise jaws—Making soft jaws—Screw drivers—Choice of screw drivers—Hack saws—How to use hack saws—Center punches—Making center punches—Driving punches—Riveting punches—Chisels—Classification of chisels—Use of chisels—Taps—Dies—Use of taps—Use of dies—Pliers—Parallel jaw pliers—Use of pliers—Wrench—Different kinds of wrenches—Anvils—Use of anvil—Clamps—Types of clamps—Use of clamps in different work—Manipulations of miscellaneous tools.....Pages 48-84

## CHAPTER III

### MEASURING INSTRUMENTS AND THEIR USE

The standards of measurement—American standards—The scale—The square—Use of the square—Adjustable squares—Calipers—

Inside calipers—Outside calipers—Shoulder calipers—Use of different types of calipers—Odd measurements made with calipers—Dividers—Use of dividers—Marking out with dividers—The micrometer—Construction of micrometer—How to read a micrometer—How to take care of a micrometer—Micrometer vernier—Micrometer vernier and how to read it—Vernier calipers—How to read vernier calipers—Use of vernier calipers as height gauge—Surface gauges—Use of surface gauges—Surface plates—Marking out with surface plates—Protractors—Use of protractors in marking out—Use of miscellaneous measuring tools.

Pages 85-104

## CHAPTER IV

### DRILLING AND REAMING

Laying out and marking work—Twist drills—Operation of twist drills—How to properly sharpen twist drills—Twist drill sizes—How to sharpen very small twist drills—Drill presses for the small home shop—Operation of drill presses—Different types of drill presses—Power drill presses—Hand drill presses—The process of drilling—Finding the center for a large drill—Drilling different metals—How to sharpen the drill for brass—How to sharpen drill for iron and steel—Speed of twist drill for the different metals and different sized drills—Vee blocks—Use of Vee blocks in drilling holes in circular pieces—Fly cutter—Use of fly cutter—How to make a fly cutter—Bottoming drill—Use of bottoming drill—Countersink—Producing square holes—Use of drift—Construction of drift—Reamers—Use of reamers—Sharpening reamers—Burring reamers .....Pages 105-126

## CHAPTER V

### INTRODUCTION TO LATHE WORK

Operation of the lathe—Simple lathes—Names of lathe parts for simple lathe—Lathe speed—Lathe tools—How to use lathe tools—How to sharpen lathe tools—Lathe dog—Turning simple work—Mounting work in lathe—Using simple lathe attachments—Use of face plate—Mounting work on face plate—Turning brass—How to sharpen tool for brass—Turning steel—Lathe chucks—Drilling on lathe—Slide rest and its use in turning—How to sharpen the various lathe tools—Lathe hand tools—Lathe power tools—General information on the operation, construction and use of simple lathes .....Pages 127-140

## CHAPTER VI

## ADVANCED LATHE WORK

Larger lathes—Description of lathe parts—Lathe saddle—Tailstock—Use of tailstock—Headstock—Slide rest—Use of slide rest—Cross slide—Center rest—Use of center rest—Live center—Dead center—How to take care of centers—Pulleys—Lathe speed—Back gears—Use of back gears for various speeds—Live center—Dead center—Grinding centers—Mounting work between centers—Lathe chuck—Lubrication and care of lathe—Setting up and driving the lathe—Power required—Setting up line shaft and countershaft—Lathe swing—Shaft hangers—Speed of line shaft—Mounting of power motor—Bench lathes—Simple turning—Boring cylinders—Machining crankcase—Making bearings—Machining odd shaped pieces of work—Use of face plate—Use of blocks and clamping bolts—Use of angle plate—Mounting casting of angle plate for machining—Turning sheet metal—Turning eccentrics—Use of mandrels—Eccentric mandrels—Turning flywheels—Boring bars—Boring tools—Use of boring bars—Turning crankshafts—Turning four-throw crankshaft—Making built-up crankshaft—Thrust bolts—Screw cutting—Placing gears for screw cutting—Grinding and mounting tools for screw cutting—Thread gauges. . . . .Pages 141-195

## CHAPTER VII

## SPECIAL LATHE WORK

Boring long holes—Use of D-bits—Construction of D-bits—Mounting gun barrel for drilling—Use of D-bit in drilling gun barrel—Reamer to follow D-bit—Cutting key-way on the lathe without milling attachment—Construction of special drilling attachment for use on small lathe—Construction and use of overhead drive for small lathe—Construction of small milling attachment for use on home shop lathe—Milling without milling attachment—Use of various milling devices—Use of special reamers—Home-made lathe tools for special purposes. . . . .Pages 196-213

## CHAPTER VIII

## GRINDING OPERATIONS

Grinding and polishing head—Choosing small grinder for shop use—Speed for grinding work—Proper speed for polishing work—

Driving the grinding head—Abrasive wheels—Physical characteristics of abrasive wheels and abrasives—Explanation of grit—Grade—Bond—Special grades—Choosing wheels for different work—Wheel faces—Precautions in mounting wheels—Testing wheels before mounting—Maintaining wheel faces—Restoring wheel faces—Dressing wheels—Simple wheel dresser—Grinding—Lapp grinding—Use of the lathe as a lapp grinder—Abrasive paper—Abrasive cloth—Lapp board—Simple grinding appliances—Abrasive powders—Abrasive grains—Use of powders and grains—Buffing—Buffing materials .....Pages 214-228

## CHAPTER IX

### PATTERN MAKING

How patterns are used—Making moulds—How casting is accomplished by the use of patterns—Moulding board—Cope—Drag—Use of cope—Use of drag—Procedure in making mould—Tools required in moulding—Tools required in pattern making—Making patterns—Simple patterns—Split patterns—Woods used in making patterns—Shrinkage of metals—Draught—Laminated patterns—Fillets—Method of making fillets—Cored patterns—Core boxes—Making core boxes—Furnace for melting brass and bronze in the home shop—Construction of furnace—Construction of burner—Gasolene tank—Use of furnace.....Pages 229-244

## CHAPTER X

### HARDENING AND TEMPERING STEEL

How steel is hardened—Essential requirements for proper hardening—Tempering—Necessary temperature—Apparatus required—Decalescence point—Recalescence point—Tempering steel—Different temperatures—Quenching—Quenching baths—Case hardening—Apparatus for case hardening—Temperature for case hardening—Materials required for case hardening—Home-made hardening furnace—Construction of home-made hardening furnace .....Pages 245-254

## CHAPTER XI

### SOLDERING AND BRAZING

Theory of soldering—Preparation of surfaces before applying solder—Fluxes—Fluxes for various metals—Making flux—Solders—Composition of solders—Solders with various melting points—

Soldering coppers—Heating soldering coppers—Blow torches—Operation of blow torches—Use of Bunsen burner in soldering—Silver soldering—Silver soldering fluxes—Silver soldering apparatus—Application of silver solder—Silver soldering various metals—Brazing—Brazing various metals.....Pages 255-266

**CHAPTER XII**

**CONSTRUCTION OF SMALL POWER DRIVEN PRESS**

Design of machine—Drawings—Making the necessary patterns—Boring the spindle arm—Boring out table—Method of holding castings to lathe for boring—Use of special boring tool—Drilling—Boring bench clamp—Drilling spindle bearing—Reaming out spindle bearing—Machining pulleys on mandrel—Tapering pulleys—Cutting keyway in spindle—Tapping—Polishing—Scraping—Finishing parts—Assembling.....Pages 267-293

**CHAPTER XIII**

**CONSTRUCTION OF A SMALL GRINDING HEAD**

Patterns—Design—Castings—Preparation of castings for machining—Drilling the main casting—Machining pulley—Turning bearing—Making shaft—Machining flange—Finishing—Assembly.  
Pages 294-300

**CHAPTER XIV**

**GENERAL INFORMATION**

How to read mechanical drawings—General or assembly drawings—Detail drawings—Sectional drawings—Lines and what they mean—Abbreviations—A. S. M. E. screw standards—Drills to use for taps—S. A. E. standards—Grinding wheel grades—Table of allowances for driving, running forced and pushed fits—Miscellaneous mathematical information .....Pages 301-314



# Shop Practice for Home Mechanics

## CHAPTER I

### Introduction to the Study of Elementary Mechanics

The three states of matter—Energy—Power—Work—Force—Application of force to matter—The lever—Pulleys—Inclined plane—The wedge—The screw—Friction—Lubrication—Gravity—Momentum—Mass—Velocity—Gears—Gear problems—How to figure for gear strength—Calculation of power—Strength of gears—Gear tables—Gear speeds—Coefficient of cubical expansion—Coefficient of linear expansion—Apparatus to indicate linear expansion—Apparatus to indicate cubical expansion—How to figure linear expansion.

A STUDY of the fundamentals of theoretical mechanics serves as a helpful introduction to the study of shop practice and processes. The great science of mechanics is based upon a few simple principles that are involved in every process or operation carried on in the shop. An understanding of these cardinal principles, even though it is an elementary one, will broaden the vision of the reader in mechanical matters and prepare him to carry on the study of shop practice more intelligently.

Matter is defined as that which occupies space. Matter exists in three states; solid, liquid and gaseous. Therefore, the science of mechanics is divided into the mechanics of solids, liquids and gases. Owing to the fact that the mechanics of liquids and gases are more or less remote from the realm of practical mechanics, the

discussion of these particular phases will end here. The mechanics of solids will constitute the subject-matter of the ensuing paragraphs.

The terms energy, power, force and work are intimately connected with the science of mechanics. The reader is cautioned not to be too presumptuous in deciding the real meaning of these terms. It is a common, but none the less serious, error to assume that these terms are analogous. In everyday terminology they are, but in scientific parlance they take on a very special and specific meaning.

Energy is present in six different forms; kinetic, potential, electric, chemical, heat, and magnetic. Energy can be readily transformed from one form into another. Through the agency of the electric battery, chemical energy is transformed into electric energy, and the potential energy in a coiled spring is changed to kinetic energy when the spring is released. Energy is never transformed from one form to another without a serious loss. In the steam-electric power plant, for instance, the loss of energy through transformation is enormous. The chemical energy released by the combustion of the coal under a boiler is converted into kinetic energy through the medium of steam and the steam engine or turbine. This kinetic energy again suffers a transformation into electrical energy through the medium of the generator. By this series of transformations, but a comparatively small percentage of the original chemical energy released by the burning coal is available in the form of useful electrical energy at the terminals of the generator.

The energy that is lost in transformation is only lost insofar as man is unable to recover it. Energy, like matter, is absolutely indestructible. It cannot be destroyed



in any known manner. The laws concerning this phase of science are called the laws of the conservation of energy. When one ball strikes another on the billiard table, most of the kinetic energy possessed by the first ball is imparted to the second one. The sudden impact causes a certain amount of the original energy to be transformed into heat. A part is also lost in the production of sound waves.

In the study of theoretical mechanics, force is recognized as that which tends to produce or modify motion. Force is usually measured in pounds. A force always has a certain direction, point of application and magnitude.

Work, although closely allied to force, has a different meaning. Work is performed when a force produces motion in overcoming resistance. Work really consists of two elements, force and motion. *Force* may be applied, but, unless motion is produced, no *work* results. In calculating work done, the magnitude of the force applied is measured in pounds and the distance moved in feet. This method of calculation has brought forth the term *foot-pound* which is the product of force (in pounds) and distance (in feet).  $\text{Work} = \text{force} \times \text{distance}$ .

Power is the amount of work done in a given time. It is generally expressed in foot-pounds per minute or second. Power can be defined as the product of force and distance divided by time. If 33,000 pounds are raised one foot in one minute, one horsepower is expended. To calculate power, it is necessary to divide the number of foot-pounds of work done in one minute by 33,000. Thus, if 66,000 pounds are raised one foot in one minute,  $66,000 \div 33,000 = 2$  horsepower.

Velocity is the rate of motion — the distance covered divided by time. It is generally expressed in feet per minute or second. The calculation of velocity does not include either force or weight. If a body moves 6,000 feet in 6 minutes, its velocity will be 1,000 feet per minute.

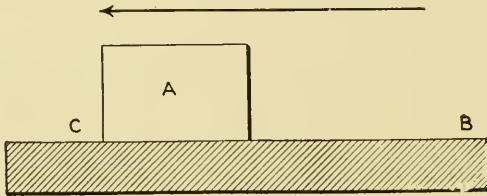

Fig. 1—The representation of forces graphically

The application of force to matter is one of the most important phases of theoretical mechanics. In Fig. 1, the body A has been moved from B to C in the direction of the arrow. The applied force is represented graphically by the straight line. The arrow gives the direction, the length of the line represents the magnitude and the end of the line the point at which the force was applied. It will be seen that the longer the line is, the greater the

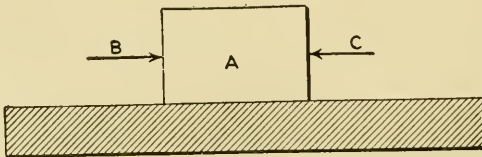

Fig. 2—Two equal forces acting in opposite directions will not produce motion

magnitude or value of the applied force because it would require a greater force to move the body A one inch than

it would to move it a half inch. The graphical representation of forces is a great aid to the study of applied forces.

In Fig. 2, it will be noticed that two forces have been applied to the body A, each in an opposite direction. This is a case of opposed forces. If the forces B and C

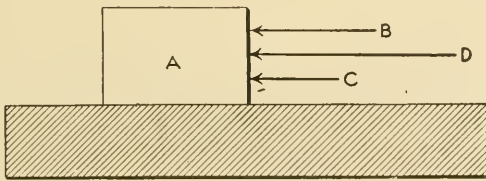

Fig. 3—The line D represents the resultant of the two forces B and C are equal, the body A will not move. However, if one force is greater than the other, the body will move a distance equivalent to the difference in the applied forces. This is in accordance with the laws of the conservation of energy.

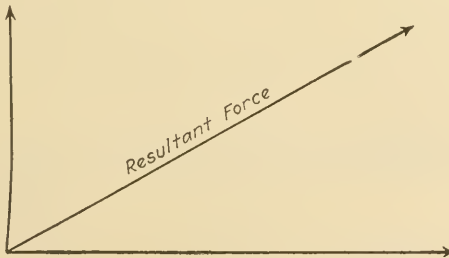
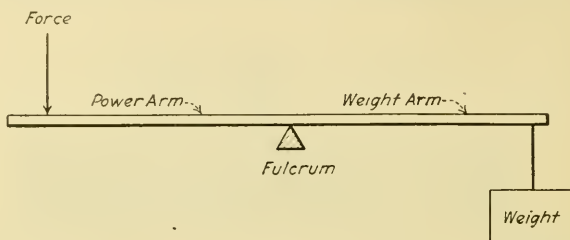

Fig. 4—The graphic representation of the resultant force of two forces of unequal value acting in the same direction

If two forces act in the same direction the value of the resultant force will be equal to their sum. This is diagrammed in Fig. 3. The force B is greater than C, but it will be seen that both forces are applied in the same di-

rection. Such forces are called parallel forces. The line D represents the resultant force, the sum of the forces B and C. If two forces act on a body in different directions as shown in Fig. 4 the resultant force can be represented by the line AB.

The study of forces and their application is an im-



**Fig. 5—A lever of the first class**

portant one owing to its relationship to mechanics. Every part of a machine moves as a result of applied force. Many important illustrations of applied force can be made by the use of the lever. The lever is a solid

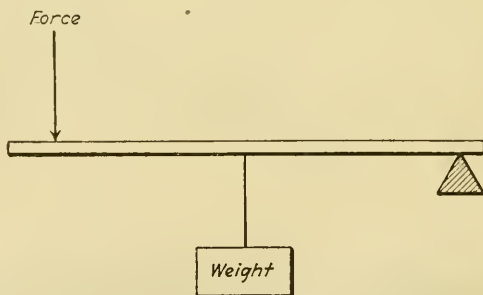

**Fig. 6—A lever of the second class**

rod mounted or resting upon a point called the fulcrum. The lever shown in Fig. 5 is called a lever of the first class. It is divided into three parts; the fulcrum, already

mentioned, the weight arm and the power arm. It will be seen that the power arm is that portion to which the force is applied, while the weight arm is that part supporting the weight. The second-class lever has the weight between the fulcrum and the force as shown in Fig. 6. A lever of the third class has the force applied between the weight and the fulcrum, as shown in Fig. 7. The fundamental law of the lever is the same for all classes, first, second and third.

To find the power of a lever of the first class (Fig. 5), the weight should be multiplied by its distance from the fulcrum and divided by the distance of the force or power from the fulcrum. The problem presented in Fig. 8 would be solved as follows:

$$\frac{8 \times 6}{12} = \frac{48}{12} = 4 \text{ lbs.}$$

From this example it will be seen that the greater the distance between the fulcrum and the applied power and the shorter the distance between the fulcrum and the

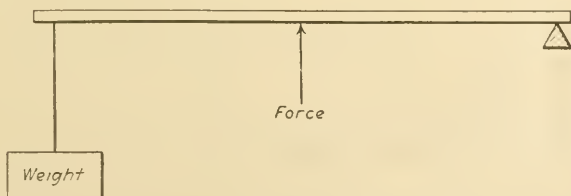

Fig. 7—A lever of the third class

weight, the more powerful the lever will be. In fact, the power of the lever is practically infinite. Aristotle was one of the first early scientists to recognize the great power of the lever.

If it is desired to calculate the weight on a lever knowing the distance it is located from the fulcrum, the force applied and the distance of the force from the fulcrum, the following mathematical practice is employed. The

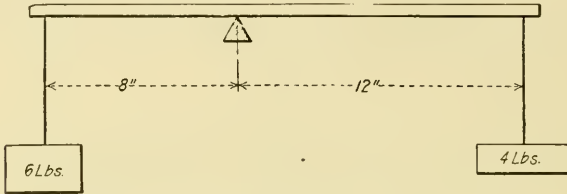

Fig. 8—A practical problem of the lever

factors of the problem are presented in Fig. 9. Here it will be noticed that the weight is located 30 inches from the fulcrum, while the force of 50 pounds is applied 5 inches from the fulcrum. The correct answer will result

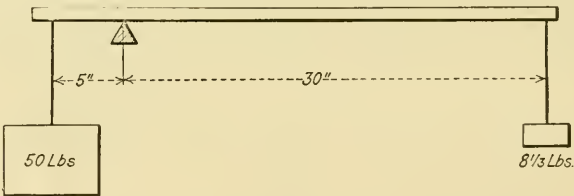

Fig. 9—Another practical problem of the lever

from the process of multiplying the power by its distance from the fulcrum and dividing by the distance of the weight from the fulcrum.

$$\frac{30}{50 \times 5} = \frac{30}{250} = 8 \frac{1}{3} \text{ lbs.}$$

Mathematical problems involving the lever could be extended indefinitely but the author feels that the few problems given will suffice to give the reader a sound elementary understanding of this particular phase of the subject.

A compound lever is shown in Fig. 10. This is a system of levers where the power arm of one rests on the weight arm of another. A very small force applied to the point A will support a comparatively large weight at B. To find the power exerted at A for the support of a specific weight at B, the weight is multiplied by the product of the short arms and divided by the product of the long arms.

To carry the explanation of the lever further, reference

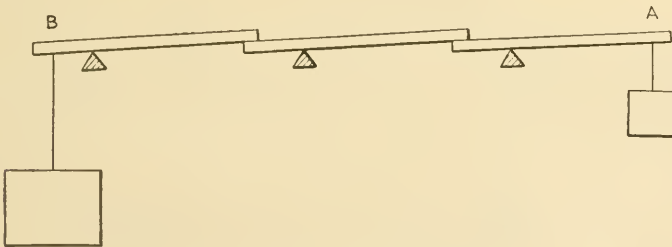

Fig. 10—A compound lever

is made to Fig. 11. A force acting upon a body tends to produce motion either in a straight or circular line. The first is called a motion of translation, the second, a motion of rotation. The lever in Fig. 11 is pivoted at A and any force acting upon it (except one which would pass through the center of the pivot as indicated by the line B) would tend to produce a rotary motion. The tendency toward rotational movement will depend upon two factors, i.e., the magnitude of the force and its dis-

tance from the pivot when measured along a line that will be at exact right angles to the line of action of the force. It will be seen that a line measured at right angles to the force, in case of the force passing through the center of the pivot, would not involve the lever at all and therefore a rotary movement would not be produced. If a force of ten pounds is applied to the lever at F, its moment (moment in mechanics means the measure of the turning effect of a force which has a tendency to produce a rotary motion) will be greater than it would be if the force was applied at the point G. This is in accordance with the law stating that the rotary motion or moment

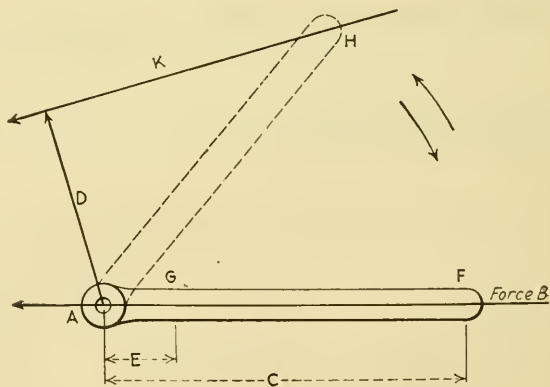

Fig. 11—Analysis of the action of forces on a simple lever

will depend upon (1) the magnitude of the force and (2) its distance from the pivot or center of motion. It will be noticed that the distance E is less than the distance C from the center of the lever, therefore the rotary effect of the force acting at point G will be less than that acting at point F. If the lever is in the position indicated by the dotted lines and a force of 10 lbs. is acting upon it in



the direction *K*, it will be found that the effective distance *D* is much less than the distance *C* when the lever was in the other position. For this reason the force, although the same in both cases, will not be as effective. In each of the cases cited, it will be seen that the actual *leverage* is equal to the distance of the lines *D*, *E* and *C*. These lines are properly called the "lever arms of the moment." The actual moment can be calculated by multiplying the force by the perpendicular distance from the axis to the line representing the direction of the force. If the distance from *F* to the center of the axis or pivot *A* is  $2\frac{1}{2}$  ft. and the force applied to the point *F* 10 lbs., the result in foot-pounds or the moment will be:

$$2.5 \times 10 = 25 \text{ foot-pounds.}$$

Mechanical movements are said to be positive or negative, depending upon their direction. If the lever in Fig.

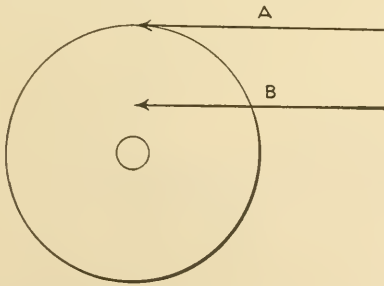

Fig. 12—The force *A* will produce motion of the wheel more readily than the force *B*

11 is moving in the direction *M*, its rotation is said to be positive because it is moving clockwise. A movement in the opposite direction is said to be negative or counter-clockwise.

A wheel acts in much the same manner as a lever. Reference is made to Fig. 12. If a force *A* acted upon the

wheel it would rotate and function in the manner of a continuous lever. It will be noticed that the tendency to rotate will be greater if the force is applied at the periphery. If a force B was applied, the tendency to rotate would be much less. In the case of the wheel shown in Fig. 13, no rotation or tendency toward rotation will be noticed, owing to the fact that the whole system is in perfect equilibrium. It will also be seen that the wheel functions as a lever; the center acting as the fulcrum and the two sides as the weight and power arms. The

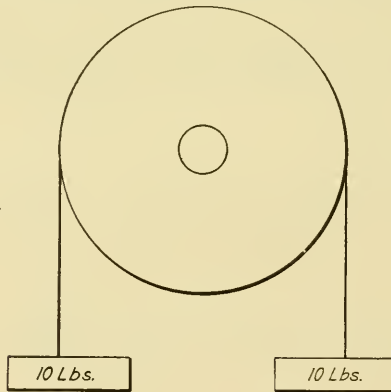

Fig. 13—Two equal forces or weights suspended as shown will not produce motion

weight is equal to the power and therefore no motion is produced.

A series of connected pulleys or wheels is called a train and the wheel which imparts the motion is called the driver. As a wheel functions as a continuous lever, a series or train of wheels will act as a system of compound levers. The lifting power of a series of pulleys is used to advantage many times. In Fig. 14, the rope A, and hence the force applied at the end, will move through

twice the distance traveled by the weight B. Therefore the weight can be equal to twice the force applied at the end of the rope. If another pulley is added to the system, a weight three times greater than the applied force can be lifted, but the distance traveled by the weight will be one-third of that traveled by the force acting at the end of the rope. With a system of seven pulleys, a weight seven times greater than the applied force can be lifted *theoretically* if the frictional losses are not considered. In this case, the weight moves through a distance that is one-seventh of that traveled by the force. With a sys-

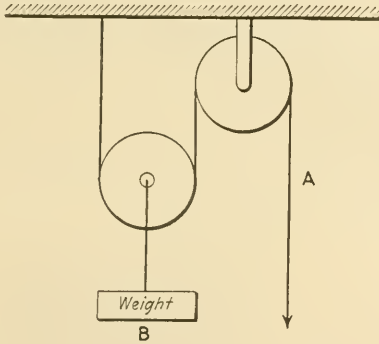

Fig. 14—A simple system of two pulleys

tem of pulleys one man can lift many times his own weight. If a system of six pulleys is used and the force applied at the end of the rope is equivalent to 50 lbs., it will be possible to lift  $6 \times 50$  or 300 lbs. If the end of the rope or the force passes through 60 feet, the weight will be lifted  $1/6$  of 60 or  $60 \div 6 = 10$  feet.

The inclined plane takes an important part in the science of mechanics. The meaning of an inclined plane becomes apparent by referring to A, Fig. 15. A plane that is at an angle (except a right angle) with a hori-

zontal plane is called an inclined plane. It will be understood that a smaller force is required to move a given weight up an inclined plane than to move it perpendicularly. The nearer the inclined plane approaches the per-

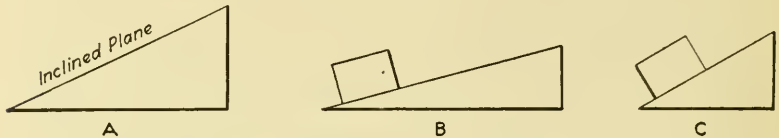

Fig. 15.—Three inclined planes of different angles

pendicular, the greater the force necessary to move it must be. The weight on the inclined plane at B, Fig. 15, could be moved with a smaller force than would be necessary to move the same weight at C where the angle is

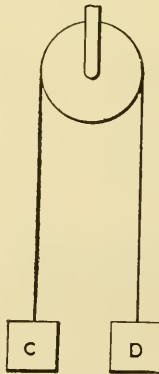

Fig. 16.—Counter-balanced weights

greater. It must also be understood that the same amount of power (not force) is required to move the weight in both instances, providing the perpendicular distances are the same. The force in moving the weight up angle B will act through a greater length of time but

the actual power (which is force  $\times$  time) will be the same as that required to lift the weight on angle C.

If a weight C, Fig. 16, was counter-balanced by a

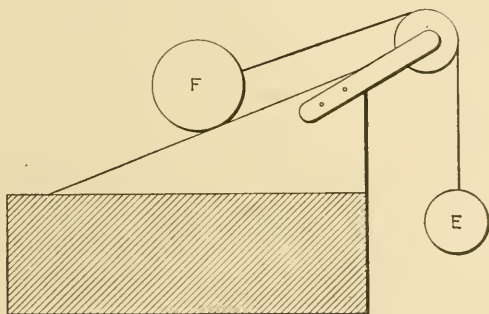

Fig. 17—Moving a weight up an inclined plane

weight D, the first weight could not be lifted until another small weight was added to D. In other words, the weight D would have to be greater than C to lift it. To prove

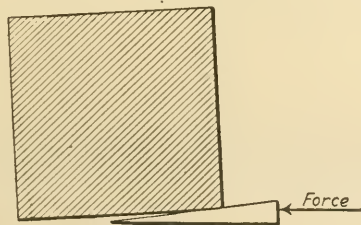

Fig. 18—Showing the use of the wedge

the mechanical advantage of the inclined plane, reference is made to Fig. 17. The weight E is able to lift the weight F up the inclined plane. The weight E is smaller than the weight being lifted, while in the case illustrated at Fig. 16 the weight D had to be greater than the weight being lifted in order to produce motion. The more the

inclined plane approaches the perpendicular, the greater the weight *E* must be to lift the weight *F*.

The power of the wedge is well known. The wedge is simply an inclined plane. Its action is illustrated in Fig. 18. By the aid of a wedge, a man is enabled to raise a tremendous weight. It must be constantly borne in mind that the same power is necessary to raise a given weight a given distance. A small force applied for a great length of time is equal to a great force applied for a short time. A man may spend half a day driving wedges under a large block of steel to lift it ten inches. A steam-driven hoist of sufficient horsepower could lift the same block the same distance in a few seconds.

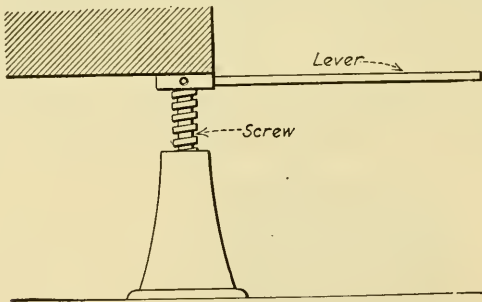

Fig. 19—Showing the use of the jack

The screw is an inclined plane and a great force can be applied by its aid. The jack (Fig. 19) is an application of the screw or inclined plane, and with it a single man can lift tremendous weights. The jack is really a combination of the inclined plane and the lever. The longer the lever of the jack is, and the less the pitch of the threads on the screw, the greater its lifting power will be.

Friction is intimately related to mechanics and it

should be thoroughly understood. Friction is the resistance to motion caused by one body sliding or rolling over another. Friction is divided into two classes: kinetic,

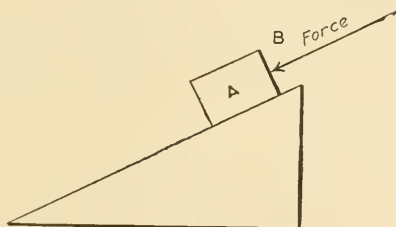

Fig. 20—A body on an inclined plane

caused by moving bodies, and static, which is the friction between the surfaces of two bodies at rest. Friction is caused by the tiny depressions and projections of one body interlocking with those of another. The more

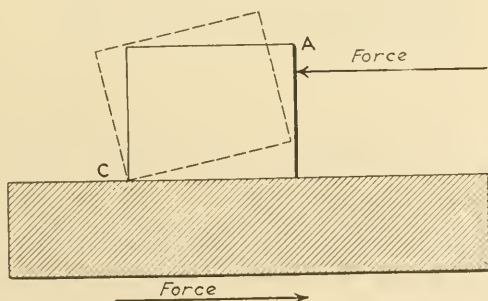

Fig. 21—How a force acting on a body at the point shown tends to produce rotation

mechanically perfect the surface of a body is, the less friction it will offer to a body sliding or rolling over it. The resistance to motion offered by friction consumes a great amount of power.

To better understand the relation between motion and friction reference should be made to Fig. 20. The body

A is at rest on the inclined plane. The static friction between the surface of the inclined plane and the body is great enough to prevent the body from sliding down the plane. If the plane is at the proper angle, the body will gain motion and slide down the plane if a force is applied at B. This proves that the static friction, or the friction of rest, is greater than the kinetic friction or friction of motion.

If a lubricant is introduced between the body and the surface of the plane, the friction will be greatly reduced. The lubricant finds its way into the interstices of the

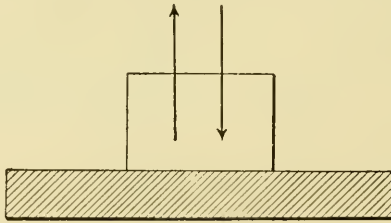

Fig. 22—Illustrating force and reaction

surfaces and fills them up. As a result of this, the friction is no longer between the body and the plane but between the surface of the body and the lubricant, and the surface of the plane and the lubricant.

If a body is at rest on a horizontal plane as shown in Fig. 21, and a force is applied to it at A in the direction indicated, the frictional resistance will cause a counter-force B to act in the opposite direction to the force that is producing motion. This counter-force will depend entirely upon the surfaces in contact. If the surfaces are smooth, the counter-force or negative force will be small. If the applied force is not greater than the negative force, no motion will be produced. If the applied force



is great enough, and the resistance high enough, the body will tend to rotate by mounting upon its edge C. The edge or point C will then act as the center of a wheel.

If a weight has to be lifted, its reactive force must be overcome. If the weight in Fig. 22 is lifted from its position, two forces must be present: one acting upward and one downward. If the upward force is great enough, the weight will be lifted.

At this juncture, it will be well to briefly consider gravity. Gravity may be defined as that attractive force

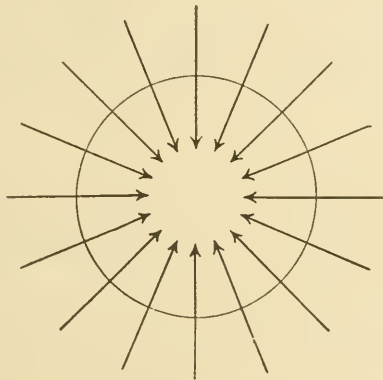
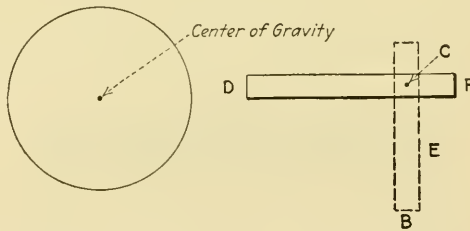

Fig. 23—How the gravitational lines converge to the center of the earth

which exists between the earth and all bodies upon the earth. The weight of a body is due to the gravitational force that is pulling it down. Gravitational influence tends to pull or move a body in a direction toward the center of the earth. The direction of the force could be represented by lines as shown in Fig. 23. This is merely an illustration to show how gravity acts and it must be remembered that the distance from the center of the earth to its surface is so great in relation to any body

upon the earth, that for all practical purposes the lines which represent the direction of gravitational force in Fig. 23 can be considered parallel.

The attractive force of gravity is the same regardless of its mass. Some bodies are so "light" that the resistance of the air partly overcomes gravitational force. A falling piece of paper will not move as rapidly as a piece of iron, but the force pulling upon it is just as great. It is erroneous to believe that the greater the mass of a body the more rapidly it will fall. The greater the mass of a body the more work will have to be performed by the gravitational force in pulling it toward the center of the earth. Therefore, a small mass will fall just as rapidly as a greater mass.



**Fig. 24**—Illustrating the center of gravity

If a circle is drawn on cardboard with a compass and then cut out as in A, Fig. 24, the center of the circle will be the center of gravity. This can be proved by mounting the circle upon a pin and placing it in a vertical plane. The disc will not move from the position in which it is placed—that is, it will not move under the influence of gravity. This is not because gravity fails to exert its force, but on account of the fact that the force is just as great on one side as it is on the other. If the piece B was mounted upon a pin at C, it would drop to the posi-

tion shown at E because the gravitational force on the side D would be greater than on the side F.

The center of gravity may be defined as that point in a body which is at the center of its magnitude. If a one-foot rule is balanced on a knife edge at its six-inch point, the rule or body is said to be in equilibrium or balance. In the study of theoretical mechanics it is assumed that gravity acts as a single force at the center of gravity in a body, but the body is really drawn down by a number of forces, acting at different points.

The center of gravity in simple geometrical figures can be readily found, providing the body is perfectly homogeneous. The center of gravity of the various figures illustrated in Fig. 25 would be found by drawing the lines shown.

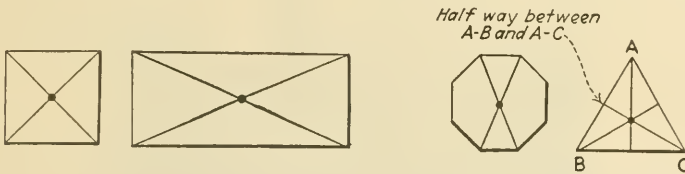

Fig. 25—How the center of gravity in simple bodies can be found by drawing lines

Inertia and momentum are two important terms which must be understood by the mechanic. Many believe that momentum is just the opposite of inertia, but this is not the fact. Newton's first law of motion states that a body at rest tends to remain at rest and a body in motion that is moving in a straight line tends to remain in motion unless it is acted upon by another force. It may be said that inertia is that property possessed by a body that tends to resist motion when at rest and to resist any force that tends to produce rest when the body is in motion. A baseball would remain in motion forever if it

was not acted upon by two other forces aside from the one which produced its motion. The resistance of the air which it is passing through gives rise to a force that is acting in the opposite direction to the force that produced the motion. The gravitational force is also pulling the ball to the earth.

The photograph (Fig. 26) illustrates a small device used in the physics laboratory to demonstrate inertia. A small ball bearing is placed on a piece of cardboard

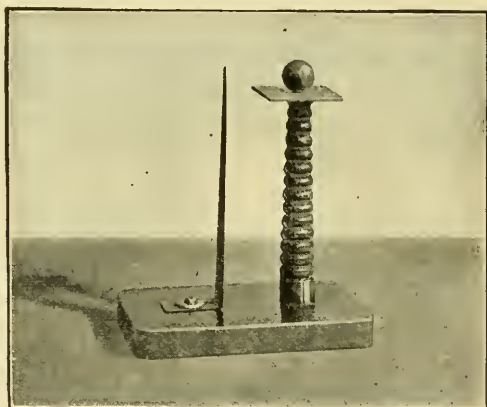

Fig. 26—A simple apparatus for the demonstration of inertia

which rests on a pedestal. A spring is mounted so that when it is drawn back and released, it will strike the cardboard a sharp blow. This forces the cardboard from under the ball, leaving it resting on the top of the pedestal. The inertia of the ball overcomes the force which tends to produce motion.

In determining the momentum of a body, mass and velocity must be considered. Momentum is really a product of mass and velocity. The greater the mass and velocity of a body the greater its momentum will be. A

small body with a great velocity may possess as much momentum as a larger body moving at less speed. A shell with a mass 1/8000 that of an express train has a striking force twice as great as that of an express train traveling 45 miles per hour. This is because of the speed of the projectile.

At this point attention will be reverted to the inclined plane and its application to the screw. It will be under-

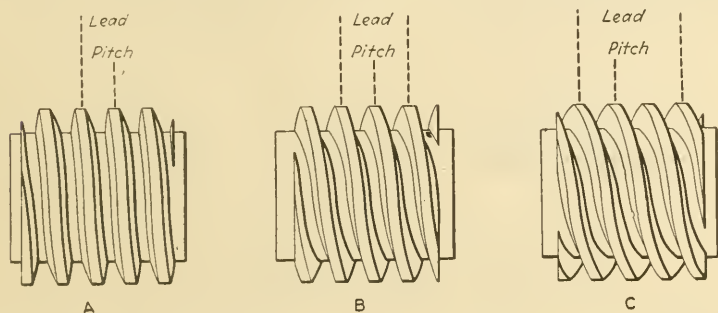

Fig. 27—Showing the meaning of lead and pitch and the relation of the two

stood that the screw is merely a continued inclined plane about a cylinder. The consideration of the screw at this time will be limited to an understanding of the terms used in connection with it.

The pitch of a thread or screw is the distance between two adjacent threads when measured from center to center. The pitch is measured in the fractions of an inch. If the threads are 1/12 of an inch apart, however, the pitch is merely called 12 in practice and the same expression is used for all fractions. It will be seen that the pitch of a thread is the distance that it will advance in one complete revolution. If the pitch is 16, the screw will advance 1/16 in. in one revolution.

The lead of a screw is the distance that it will advance

in one complete revolution and it must not be confused with pitch. In the case of a single thread such as that shown at A, Fig. 27, the pitch and the lead will be the same but in the case of a double thread as illustrated at B, the lead will be twice as great as the pitch. At C, the lead is three times as great as the pitch. A single thread is one in which the lead is equal to the pitch. A double thread is one in which the lead is twice the pitch and a triple thread has a lead three times the pitch.

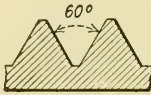

Fig. 28

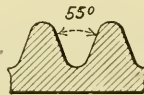

Fig. 30



Fig. 29

- Fig. 28—The United States Standard thread  
 Fig. 29—The standard V-thread  
 Fig. 30—The English Whitworth thread

The root diameter of a screw is the diameter measured at the bottom of the thread. The external diameter is the outside measurement over the top of the thread or at the widest point.

All threads are not of the same shape. In this country, the United States Standard is the most widely used thread. An outline of this particular thread is given in Fig. 28. Aside from the U. S. Standard thread, the V-thread is used to a great extent. The shape of the V-thread is outlined in Fig. 29. The principle objection to a thread of this nature is its extreme sharpness. The top of the thread which comes to a point is almost impossible to cut, and once cut it wears away very rapidly and causes the screw to become loose. The American Society of Mechanical Engineers adopted a standard thread which is used to a great extent as well as the standard

adopted by the Society of Automotive Engineers. Both of these threads are very similar in shape to the U. S. Standard. The standard adopted by the American Society of Mechanical Engineers is represented by the initials A. S. M. E., while that of the Society of Automotive Engineers is known as the S. A. E.

The standard thread used in England is known as the Whitworth. The shape of this thread is shown in Fig. 30. It will be seen that the Whitworth thread is at 55 degrees while all the American standards are at 60 degrees. Another very noticeable feature of the Whitworth thread is its round top. The Whitworth thread is not used to a great extent in America.

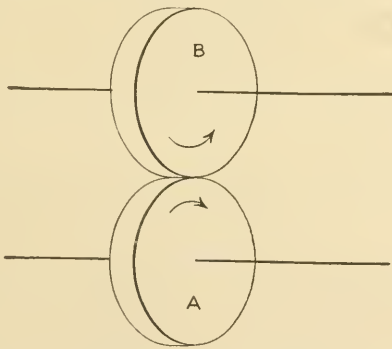

Fig. 31—Illustrating the principle of gearing

The subject of screw threads will be resumed in that portion of the volume which treats thread cutting.

The gear takes a very important part in mechanics and it is quite necessary that the mechanic become acquainted with it. Gears are used entirely for the transmission of power and motion. The illustration (Fig. 31), shows how motion or power can be transmitted by the use of two small wheels. The motion is transmitted from wheel

A (which is the driver) to B, by friction. Such a method is very unsatisfactory, as a large percentage of the power and motion will be lost by slippage. To overcome this loss a more positive drive can be produced by cutting teeth in the perimeter of the wheels. The teeth in one could be cut the same as the teeth in the other. If this is done, the wheels, or gears as they are now called, will fit together—the teeth of one wheel fitting into the depressions of the other and *vice versa*. In this way the gears are said to be in mesh.

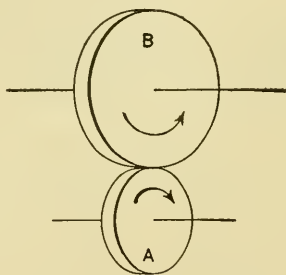

Fig. 32—In gearing the speed is controlled by the proper choice of gears

By reverting attention to Fig. 31, it will be seen that for every revolution the wheel A makes, B will also make one. (This is, of course, assuming that the frictional losses are nil.) This is because the two wheels are of the same size. If B had twice the circumference of A, as illustrated in Fig. 32, the speed of B would be one-half that of A. It will be seen that A must revolve twice for every revolution made by B. If the circumference of B was five times greater than that of A, the speed would be one-fifth that of A. It will be noticed that two or more gears revolving together act as a system of continuous levers.

Gear wheels are very scientifically made and accurately



cut. The various terms employed in connection with gear wheels will be made clear by reference to Fig. 33.

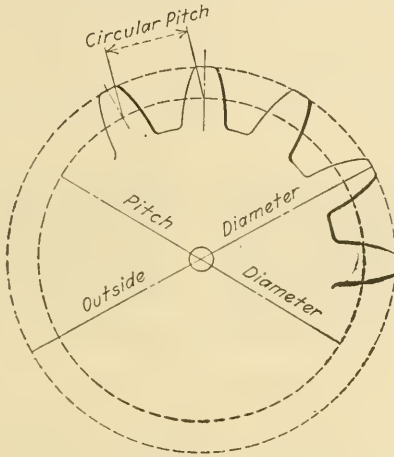

Fig. 33—Showing the meaning of circular pitch, pitch diameter and outside diameter

The pitch circle or diameter of a gear wheel is really the diameter of a plain cylinder without teeth that the

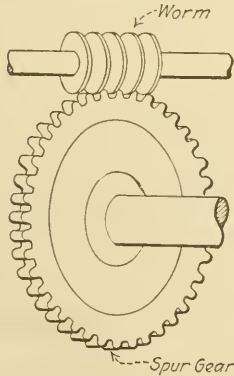

Fig. 34—Showing the use of a worm

gear may be considered as replacing. This theoretical or imaginary line is represented by the dotted line. The

circular pitch of a gear wheel is the distance from the exact center of one tooth to the center of the next one at the point where the pitch line or circle passes through. This is shown clearly in Fig. 33.

Worm gears are really screws that mesh with gear wheels especially designed for this use. Such an ar-

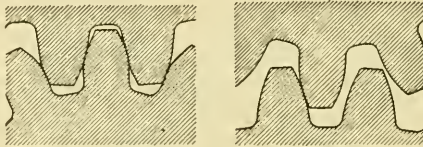

Fig. 35—Proper and improper meshing of gears

range ment for the transmission of power or motion will be better understood by referring to Fig. 34. It will be seen that the spur must be driven by the worm as it is impossible for the gear to turn a worm with the pitch shown. The number of revolutions of the worm to produce one complete revolution of the gear will depend

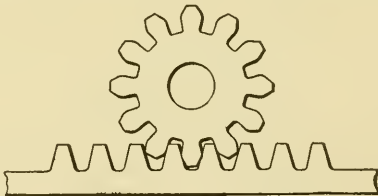

Fig. 36—A rack and pinion

upon the pitch of the worm when considered as a screw. Such arrangements as that shown in Fig. 34 are used when low speed and maximum transmission of power is wanted.

Gear wheels to work efficiently and without undue noise or wear must mesh properly; their axes of rotation must be a specific distance apart, depending upon the pitch circle. The proper position of the teeth of the two gears

is shown in Fig. 35 at A. The improper method of meshing the gears is shown at B.

Another arrangement to produce motion or to transmit power by the use of gears is depicted in Fig. 36. The small gear (commonly called a pinion when used in this

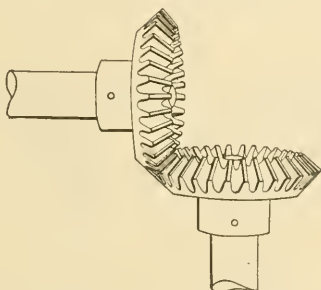

**Fig. 37—Miter gears**

way) is so mounted that its teeth mesh with the teeth on a straight piece. The straight piece is called a rack. The speed of the rack for a given speed of the pinion will depend entirely upon the pitch diameter of the pinion.

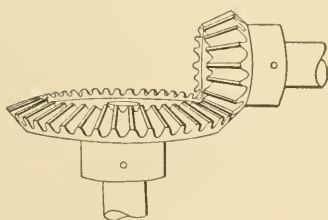

**Fig. 38—Bevel gears**

Motion is transmitted at right angles by the use of bevel, miter or crown gears. The teeth in miter gears are mounted at 45 degrees so that when they mesh the shafts upon which they are mounted will be at right

angles. The arrangement is illustrated in Fig. 37. Bevel gears are shown in Fig. 38. Crown gears are used many times to replace bevel and miter gears. The use of the crown gear is clearly illustrated in Fig. 39.

To enable the reader to become more fully acquainted with the subject, a practical problem involving a simple

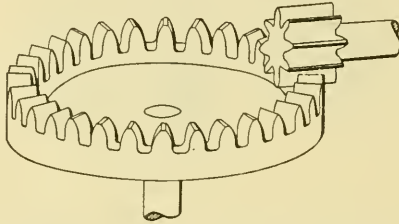

Fig. 39—A crown gear and pinion

formula will be considered. The shaft A (Fig. 40) is to be driven and calculations must be made to determine the proper gear to use. The power necessary to turn

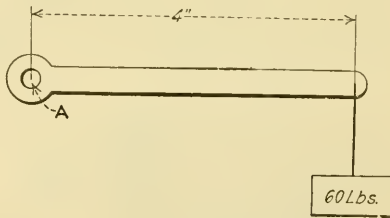

Fig. 40—Method of calculating the power necessary to operate a lever

the shaft must be calculated and after the answer is found in horsepower, it is a simple matter to find a gear that will transmit this power. A lever is fastened to the shaft as shown, and the weight on the end of the lever is increased until the shaft is moved. It will be understood that the length of the lever is quite unimportant as the

result will be the same. The longer the lever is, the less weight will be needed to turn the shaft. In the case under consideration, it will be assumed that the lever is 4 inches long and that a weight of 60 pounds is necessary to produce motion. The prime mover which will drive the shaft revolves at 1200 R.P.M., and the shaft is to be

STRESS TABLES FOR BRASS, IRON, BRONZE AND STEEL

| VELOCITY IN FEET PER MINUTE | BRASS OR CAST IRON | BRONZE | STEEL |
|-----------------------------|--------------------|--------|-------|
| 0                           | 7000               | 10000  | 17000 |
| 100                         | 6000               | 9000   | 15000 |
| 200                         | 5500               | 8000   | 13000 |
| 300                         | 4700               | 7000   | 12000 |
| 450                         | 4000               | 6000   | 10000 |
| 600                         | 3500               | 5500   | 8500  |
| 900                         | 2800               | 4200   | 7000  |
| 1200                        | 2300               | 3500   | 5800  |
| 1800                        | 1500               | 2250   | 4200  |
| 2400                        | 1300               | 2000   |       |

Fig. 41—Stress of metals used in gears

driven at 200 R.P.M. This is a reduction of 1 to 6 (1200 ÷ 200). With this information available, the following formula is employed in calculating the horse-power necessary to drive the shaft:

$$\text{H.P.} = \frac{33000 \times 6}{60 (4 \times 3.14) 200} = 1.31 \text{ H.P.}$$

The result of this calculation shows that a gear must be used that will transmit 1.31 H.P. with a reasonable factor of safety. One of the first considerations will be the size of the gear to be used. If the speed reduction is to be 1 to 6, it will be understood that the driving gear must have a pitch circle 6 times larger than the gear on the shaft to be driven.

The following formula is used to determine the size of the gear to be employed:

$$L = \frac{FSY}{P}$$

Where:

L = Safe working load.

F = Face or width of gear in inches.

S = Stress of the material used in gear (given in Fig. 41).

Y = Factor for number of teeth (given in Fig. 42).

P = Diametrical pitch (the pitch diameter divided by the number of teeth).

| Number Teeth . . . . . | 12-18 | 19-25 | 26-38 | 39-60 | 61-150 | 150- |
|------------------------|-------|-------|-------|-------|--------|------|
| Factor Y . . . . .     | .230  | .285  | .320  | .350  | .365   | .380 |

Fig. 42—The Y factor for gears with from 12 to 150 teeth

Upon referring to a gear catalogue, it is decided to use a gear with a pitch of 16, with 16 teeth for the shaft of the prime mover. The above formula will be applied to a gear with a  $\frac{1}{2}$ -in. face. All the necessary factors are then available and they can be outlined in this manner:

Face = .1 inch.

Stress = 5500 (for bronze):

Factor Y = .230.

Pitch = 16.

The solution of the problem is then arrived at as follows:

$$L = \frac{.1 \times 5500 \times .23}{16} = 7.88 \text{ load.}$$

From this it will be seen that the 1-inch gear of bronze

with a pitch diameter of 16 will be a suitable one to use on the shaft of the motor. The same formula can be applied in all problems of this nature where the safe working load of a gear must be calculated.

When metal is heated it expands. Its expansion increases uniformly with the increase in temperature. It has been found by experiment that every metal or alloy expands a definite amount for every degree increase in temperature. This is called the coefficient of expansion. It is different for different metals and alloys. The table below gives the coefficient of expansion for different metals and alloys:

|                          |          |
|--------------------------|----------|
| Aluminum .....           | .0000232 |
| Lead .....               | .000029  |
| Steel (tempered) .....   | .000013  |
| Zinc .....               | .000029  |
| Brass .....              | .0000189 |
| Gold .....               | .000014  |
| Platinum .....           | .000083  |
| Steel (untempered) ..... | .000011  |
| Copper .....             | .000017  |
| Iron .....               | .0000112 |
| Silver .....             | .000019  |
| Tin .....                | .000022  |

The linear expansion of a metal bar can be made visible by the use of the machine shown in Fig. 43. The long tube A is used as a steam jacket and the metal rod to be tested is arranged concentrically within it. The thermometer records the rise in temperature and the micrometer measuring device at the end shows the expansion in hundredths of millimeters. Steam from a boiler enters the tube at the end. Steam that condenses

is run off into the receptacle. First, the length of the rod while cold is determined. After the rod is put in place, the end of the micrometer rod is turned until it touches the end of the metal rod under test. When it touches, an electric circuit is completed. This causes a small electric bulb to light. This measurement is recorded as the cold length of the rod. After the cold measurement has been taken, the micrometer rod is re-cessed and live steam is admitted to the tube. After the temperature has raised to a point where it remains uniform, another measurement is taken and when the first

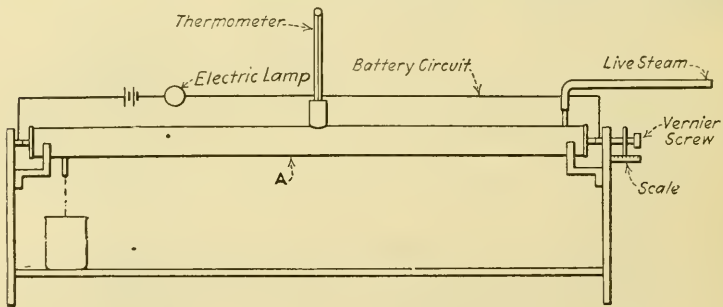

Fig. 43—Machine used for the measurement of linear expansion

reading is subtracted from this, the result is the expansion that has taken place. The micrometer measuring device at the end of the instrument is very simple. The projecting scale is graduated to read in millimeters. The vernier is graduated in the hundredth part of a millimeter.

If it is desired to know the linear expansion of a metal bar when its temperature is raised 100 degrees Centigrade, a simple mathematical formula can be applied instead of using the machine described above. It will be assumed that an iron rod 10 feet long is heated



100 degrees. The coefficient of expansion for iron is .000029. Therefore, the increase in length will be  $.000029 \times 100 = .0029$ . This figure is multiplied by the number of units of length (the unit of length is the foot) in the bar. Thus:  $.0029 \times 10 = .029$ . This, added to the cold length of the bar, makes its length at 100 degrees Centigrade 10.029 feet.

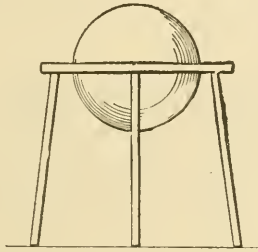

Fig. 44—Simple apparatus to show cubical expansion

A simple device which is often used in the laboratory to demonstrate the cubical expansion of a metal ball is depicted in Fig. 44. When the ball is cold it will just pass through the opening in the stand. When its temperature has been raised a few degrees, however, the ball will expand to such an extent that it will no longer pass through the opening.

## CHAPTER II

### The Use of Miscellaneous Tools

Different kinds of hammers—Choice of hammers—Files—Choice of files—Classification of files—Use of files—Flat filing—Draw filing—Round filing—Scrapers—How to make scrapers—Proper use of scrapers—Vises—The vise used as a press—Vise jaws—Making soft jaws—Screw drivers—Choice of screw drivers—Hack saws—How to use hack saw—Center punches—Making center punches—Driving punches—Riveting punches—Chisels—Classification of chisels—Use of chisels—Taps—Dies—Use of taps—Use of dies—Pliers—Parallel jaw pliers—Use of pliers—Wrench—Different kinds of wrenches—Anvils—Use of anvil—Clamps—Types of clamps—Use of clamps in different work—Manipulation of miscellaneous tools.

THIS chapter will be devoted to the use of miscellaneous tools employed about the home shop. While

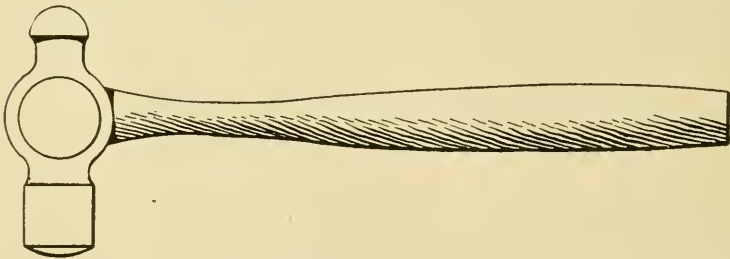

Fig. 45—A machinist's hammer with ball pene

many of the tools included are extremely simple, this does not necessarily hold regarding their manipulation.

The home shop should have at least two hammers.

These should be of the machinists' type similar to the one shown in Fig. 45. Machinists' hammers are classified according to weight; heavy, medium and light weight. For the small shop a medium and light weight hammer will be needed, but, owing to the class of work done, a real heavy hammer will not be needed. The length of the handle of the medium weight hammer should be about twelve inches and the light weight hammer should have a handle about ten inches in length. The longer the handle of a hammer is, the greater its striking force will be. For this reason the heavier hammers have longer handles than the light ones. Hammers are made with ball and straight penes. The ball pene, however, will be found quite suitable for most uses.

Although the hammer is a very simple tool, it requires considerable skill and experience to use it properly. Part of the skill in the use of the hammer comes in aiming so that it will hit the part of the work it is intended to hit. Oftentimes a poorly directed blow of a hammer will completely ruin a piece of work. The amateur mechanic should be particularly careful in directing the blows of his hammer until he is able to more accurately control his aim.

It will be noticed that the face of the hammer is slightly convex. The pene is semi-spherical in shape so that it can be used for forming concave impressions in light sheet metal, etc.

The file is one of the most important small tools used about the shop and very few mechanics know how to use it properly. Skillful manipulation of the file is only attained after considerable experience in the shop and the best the following paragraphs can do is to describe the various files and the proper method of using them. Many

operations can be accomplished with the ordinary file when it is in the hands of a skilled mechanic.

Files are classified as rough, coarse, bastard, second cut, smooth and dead smooth. Files are also known as

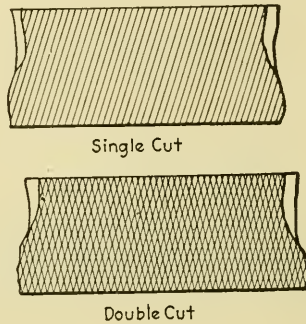

**Fig. 46—The teeth of a single-cut and double-cut file**

double-cut and single-cut, depending upon the arrangement of the teeth. In the single-cut file, all the teeth are parallel and at the same angle—from 60 to 80 degrees.

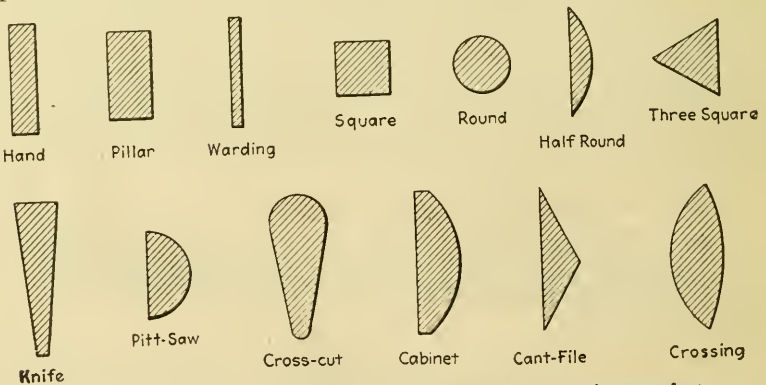

**Fig. 47—The various-shaped files that are on the market**

The double-cut file has two sets of teeth, each at a different angle. The difference between the double- and single-cut file is depicted in Fig. 46. The teeth in a

double-cut file are generally at an angle of 40 degrees in one direction and from 75 to 80 degrees in the opposite direction.

Files are manufactured in a multitude of different shapes, and many are made for very special purposes.

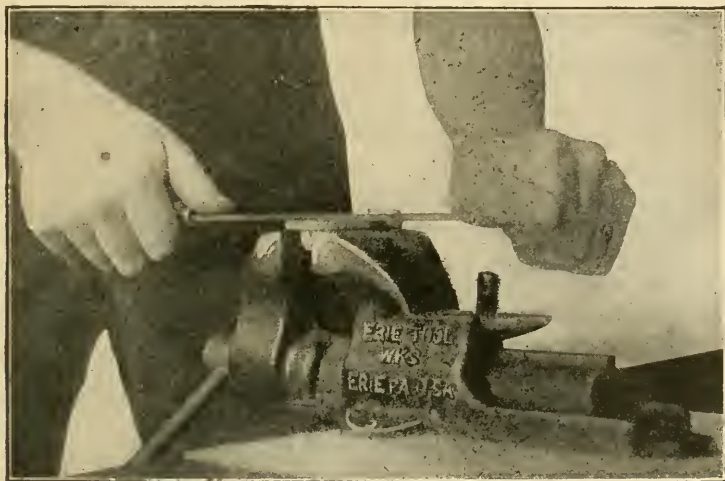

Fig. 48—Improper method of holding a long, thin file

A cross-section of all the common shapes is shown in Fig. 47. Files are made in many different lengths, the shorter type being used for fine work while the larger



Fig. 49—How a thin file will bend when held in the manner shown in Fig. 48

ones are used for heavier work. Files of the same grade have the same number of teeth per inch only when they are the same length. Thus, a second-cut file 9 inches in length would be more coarse than a second-cut file 5 inches in length. This is quite necessary as a bastard

file 4 inches in length would have but a few teeth upon its surface. Therefore it is necessary to reduce their size in proportion to the length of the file. This must be kept in mind when dealing with ordinary files. It must

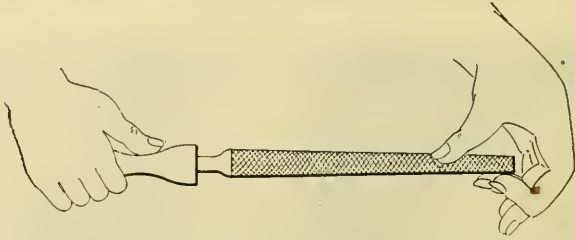

**Fig. 50**—Proper method of holding a long, thin file

also be understood that the length of the file does not include the tang which is the part that holds the handle.

The first thing that the mechanic must learn in using a file is the method of holding it. A file can only be used advantageously when it is held properly. In ordinary



**Fig. 51**—(A) A file held in the manner pictured in Fig. 48 will cut the corners of the work off as shown. (B) How a file bends when held in the manner pictured in Fig. 50

cross filing—that is, filing directly across the work—a thick, medium-sized file should be held as shown in Fig. 48. When holding the file in this manner, it will be found that it can be controlled very easily and that the hands are not easily fatigued, owing to the fact that it is not necessary to tightly grip the file. The forward stroke of the file should be firm and positive as the file only cuts when moving in this direction. The return stroke should be very light to prevent the teeth from wearing down.

If a long, thin file is held in the manner depicted in Fig. 48, it will have a tendency to bend as shown in Fig. 49. In such instances, the position of the hands can be changed to that shown in Fig. 50. When held in this manner it will be found that exceptionally flat surfaces can be produced. This is made possible by the file slightly bending so that its cutting side becomes convex. When a thin file is held as shown in Fig. 48 it will cut

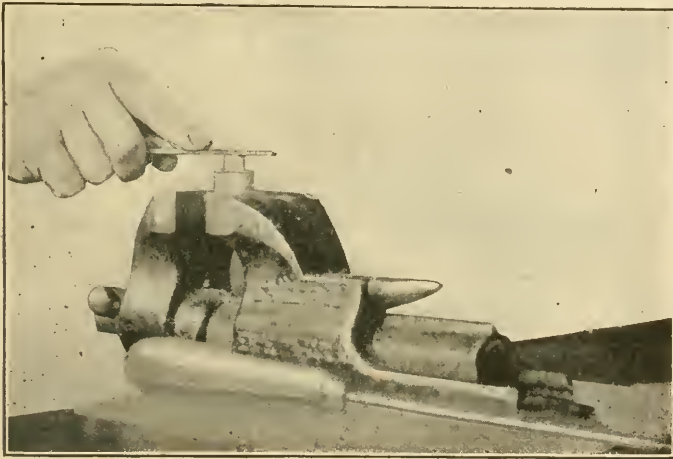

Fig. 52—The proper method of holding a small file with the fingers

the edges off the work as illustrated in Fig. 51 at A. This is due to the downward pressure at the ends. An upward pressure at the end caused by holding a thin file as illustrated at Fig. 50 will make it bend in the opposite direction as shown in Fig. 51 at B.

If a perfectly flat surface is to be produced, it will be necessary to use a file with a slight "belly." A perfectly flat file cannot be employed for the reason that it is almost impossible for a mechanic to hold it truly parallel

with the surface being filed. Files are manufactured with a slight "belly" at the heel (the heel is the end opposite to the tang or handle) and such files are said to be tapered. The careful workman always selects a tapered file if he has any flat surfaces to produce. Such a file must move from one edge of the work to the other to prevent a concave surface being produced. A tapered file, or one having a "belly" can be found by running the eye along the surface.

When a very small file is being used on delicate work,

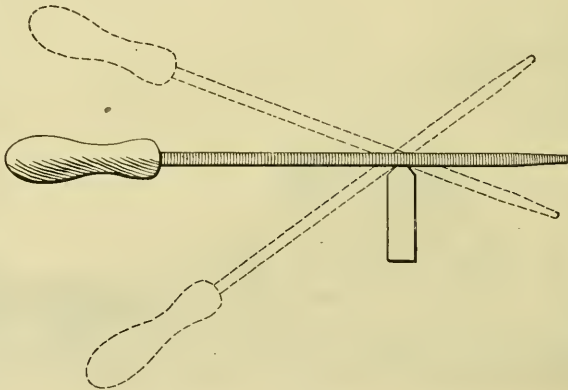

Fig. 53—Method of cutting fast with a file

it is generally held in one hand as shown in Fig. 52. It will be found that a remarkable control can be had over the movement of the file when held in this manner.

In heavy cross-filing where great pressure must be used in holding the file to the surface of the work during the cutting stroke, the mechanic should stand back from the work with one foot in advance of the other. On the cutting stroke the body should be braced against the rear foot, at the same time relieving the pressure on the forward foot. On the return stroke, the weight of the body



should be shifted to the forward stroke and all the pressure exerted on the file should be relieved. The file should be completely removed from the surface of the work when it is wished to examine the surface.

When a great amount of stock is to be removed, the direction of the stroke of the file should be changed occasionally. This will greatly facilitate the removal of metal. If a large amount of metal is to be removed from a very narrow surface, the direction of the stroke should be changed occasionally as depicted by the dotted lines in Fig. 53. When a narrow piece is filed in this manner, a new file should never be employed as but a few teeth

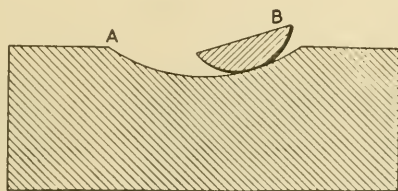

Fig. 54—A half-round file should be run from one side of the work to the other, as from A to B

come in contact with the work at a time and they are apt to take hold so freely that their edges will be broken off.

Before selecting a file for a certain job, the mechanic should always take note of the metal to be filed, the size of the work and the amount of stock to be removed.

Half-round files (they are commonly called half-round but they are really about one-third round) are used as illustrated in Fig. 54. The cutting stroke should be a sweeping one, starting at one side and ending at the other. The position A is the starting position and the position B is where the cutting stroke ends.

When a round hole is being filed out with a round file, the diameter of the file should be as close to the diameter of the hole as possible without interfering with the movement of the file. If a file the diameter of the dotted lines

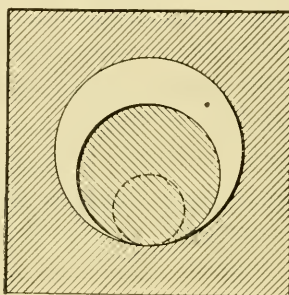

Fig. 55—Showing the proper size round file to use in filing out a round hole. The mechanic will get a good idea of the relation of the file to the hole by studying this sketch

(Fig. 55) is used it will produce ridges in the surface. This can be avoided by employing a larger file as shown by the full line.

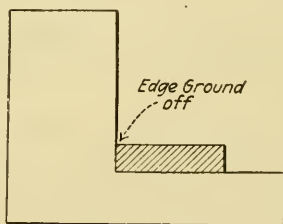

Fig. 56—Showing the advantage of grinding one edge of a file off for work of the nature illustrated

Oftentimes there is a surface at right angles to the one being filed and which is in a finished condition and with which the worker does not wish to bring his file in contact. This can be avoided by employing a file with one edge ground off. This is shown in Fig. 56.

If a slot is to be cut, it is first drilled out roughly as illustrated in Fig. 57. After the drilling is finished, a flat file is inserted and the superfluous metal is removed in this manner.

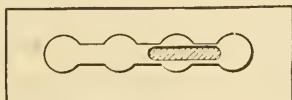

Fig. 57—Method of making a slot with a file

Draw filing is shown in Fig. 58. While it is impossible to remove metal quickly by this method, it will produce more accurate results than cross filing and it is therefore a better method for the more unskilled mechanic.



Fig. 58—Draw filing

After a file has been used for some time the space between the teeth becomes filled with metal chips. Part of these can be removed by striking the file a sharp blow on the edge of the bench. Those that are not dislodged in this manner must be removed with a file brush (see Fig. 59). Some of the tiny pieces of metal will be

wedged so tightly between the teeth that it will be necessary to employ a sharp-pointed rod to remove them. Such rods are generally furnished with file brushes.

The small shop should be equipped with at least a dozen files of different shapes and cuts. If very small work is being done, an assortment of files known as "Swiss" files should be purchased. These files can be

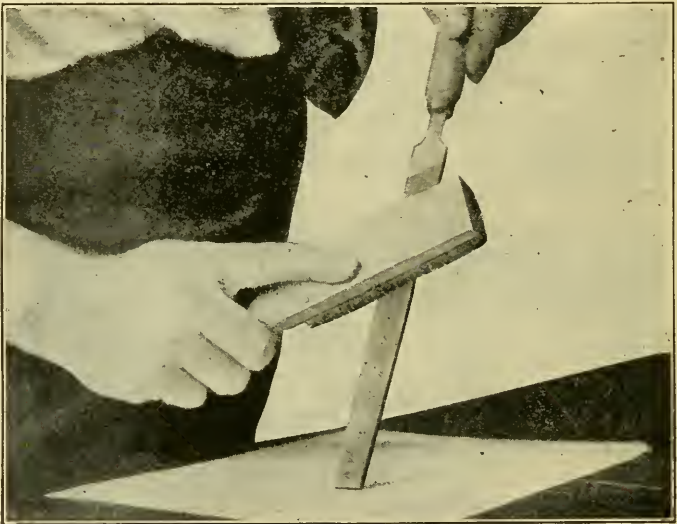

Fig. 59—Cleaning a file with a file brush

obtained in a multitude of shapes and grades. They are especially manufactured for small, delicate work.

As a resumé of what has been said concerning the classification of files, it can be repeated that they are designated according to their length, cross-section, cut (double or single) and coarseness.

The process of scraping is closely allied with that of filing and it will be well to consider it at this point.

Scraping is generally resorted to when it is impossible to use a file.

A very useful little scraper for many purposes can be made from a small triangular file. The teeth are carefully ground off on an abrasive wheel and the edges are then rubbed with a small carborundum stone to sharpen them. In grinding the teeth off, the file should be dipped in water occasionally to cool it. If this is not done, it may undergo a process of tempering which will soften it considerably. The scraper should be provided with a small wooden handle as shown at A in Fig. 60. This

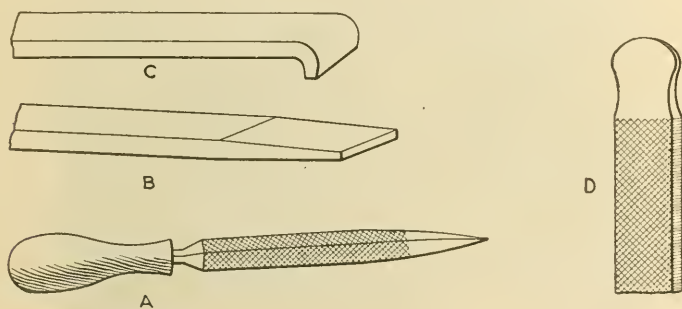

Fig. 60—Different types of scrapers

scraper will be found very efficient in removing burrs from metal tubing after it has been cut off in the lathe. One of the edges is pressed firmly against the inside edge of the tube while the lathe is revolving. This will quickly remove the burrs, leaving a nice, smooth edge. Burrs can also be removed with this scraper when the work is held in the hand, but it is more convenient when the lathe is used. It will also be found that this tool can be used for scraping the whole interior surface of a soft metal tube when it is revolving at high speed in a speed lathe.

There is often occasion to employ a flat scraper in the shop for various jobs and the beginner will be surprised to know that surfaces produced by the aid of this simple tool are much more accurate than those produced by a file. A flat scraper is outlined at B, Fig. 60. This can be ground to shape from a ten- or twelve-inch file. A file with sufficient thickness should be used as the scraper is subjected to considerable strain when in use. The

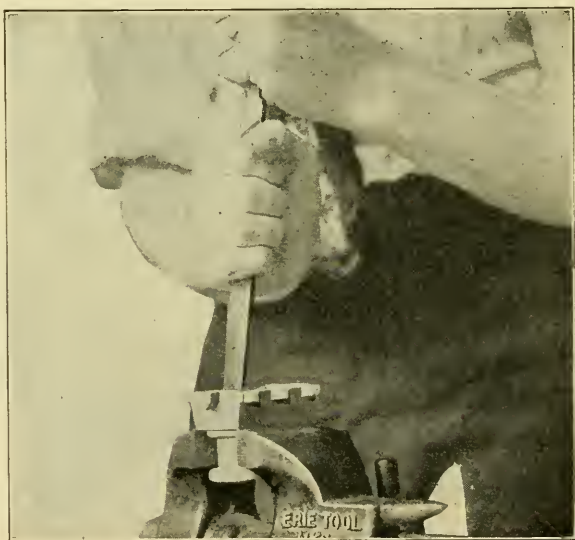

Fig. 61—How a scraper is held in working

cutting end should have a thickness in the neighborhood of  $\frac{1}{16}$  to  $\frac{1}{8}$  inch. The cutting edge should be ground at exact right angles and slightly rounded at the extreme corners. This is to prevent the corners from scraping or gouging small valleys into the surface of the work. The tool should be drawn across the work firmly and with considerable pressure. The method of holding scrapers

is shown in Fig. 61. The edge of the scraper should be kept keen by giving it an occasional rubbing with a small hand stone.

Another type of scraper is depicted at C in Fig. 60. It is necessary to forge this tool as its end is bent over at right angles. This tool has one disadvantage; its cutting edge is obscured. The tool is drawn toward the user and it is capable of doing very fine work.

A scraper with a circular cutting edge is necessary when working with concave surfaces. Such a scraper is

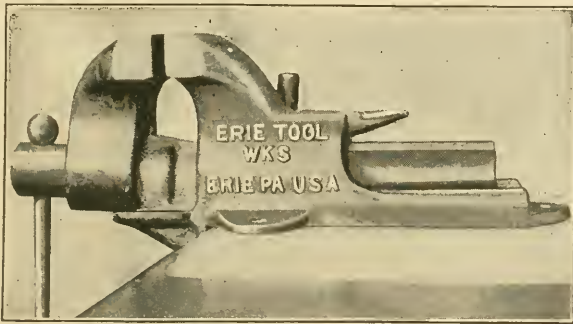

Fig. 62—A very substantial vise for the home shop

shown at D, Fig. 60. It is used in the same manner as the first straight scraper described. The straight scraper can be used on convex as well as plain surfaces.

The small shop should have in its equipment at least two vises—a heavy one for the larger work and a small one to accommodate smaller pieces. The mounting of a vise is very important as it should be at the proper height to suit the workman who is going to use it. To determine the distance which the vise should be mounted from the floor, the mechanic should stand with his hand placed on his chin and when in this position the top of the vise should be high enough to rest the elbow on. The me-

chanic should stand perfectly erect when making this determination. The vise should be securely bolted to the bench and the bolts should pass completely through the bench. It must be remembered that a vise is subjected to great strain when the jaws are tightened. If it is mounted badly it will soon become loose and therefore it is best to mount it securely the first time. A photograph of a medium-sized vise, suitable for use in a small shop, is shown in Fig. 62.

When carefully finished work is held in the vise the jaws will leave ugly impressions upon the surface of the work when it is removed. This can be overcome by fitting lead covers over the jaws. Lead is very soft and will hold polished work without marring its surfaces. If an especially tight grip is necessary the lead is very apt to be cut and in this event soft brass jaws can be substituted. Before mounting the brass covers in place they should be heated to redness and immersed in cold water to soften them. This process may appear to be wrong to those who understand that steel is hardened by heating it and then immersing it in a cold fluid. Just the opposite holds true of brass; it is softened when heated and suddenly cooled.

Oftentimes it is necessary to hold a piece of work in the vise which does not have parallel sides. This difficulty can be overcome in many cases by employing the small device shown in Fig. 63.

It will be understood that the vise is a combination of the lever and screw or inclined plane, and therefore a tremendous pressure can be exerted between the jaws. This pressure can be taken advantage of many times when forcing one piece of metal into a hole in another piece. If a piece of heavy metal tubing, for instance, is



to be flattened at one end, this can be accomplished in the vise with accuracy and ease. All large vises are provided with an anvil at the back which will be found very convenient in many operations.

It may seem absurd to many to mention such a simple detail as a screwdriver and yet few mechanics use discretion in choosing these important devices. The home shop should boast of an assortment of screwdrivers numbering at least five; from a large heavy one to a small delicate one for the most minute screws. There is prob-

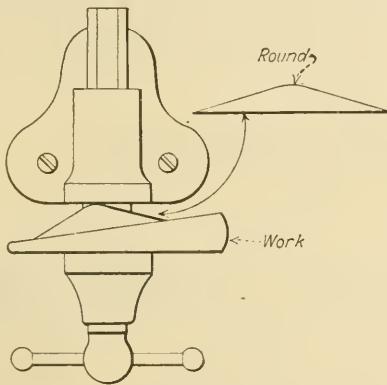

Fig. 63—Holding odd-shaped pieces in the vise

ably no other tool that will destroy itself more quickly than a screwdriver if it is of poor quality. When a screwdriver is purchased it should be of the best quality obtainable with a solid wooden handle well secured to the metal part. The point of a screwdriver should be well taken care of and it should not be allowed to become blunt and badly worn. This will cause it to twist screw heads out of shape and to slip out of the slot when great twisting force is exerted. It is a very easy matter to keep the point of a screwdriver well trimmed and square

by the use of a good sharp file or grinding wheel. As the point is filed back the taper should also be increased so that the edge will always be the same width. The screwdriver should never be used as a chisel or cutting tool. In some shops its use ranges from a wood gouge to a nail set.

A hack saw is an important and much-used tool. A typical hack saw is illustrated in Fig. 64. It will be seen that it consists of a frame with a handle on it and the cutting element or blade is held tightly in the frame. The blade is a thin piece of very hard steel with teeth on one edge. The blade has a small hole at each end and these fit over pins in the frame. When the blade is in

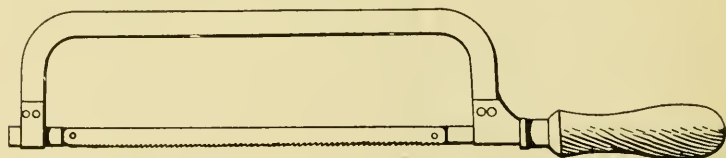

Fig. 64—An ordinary hack saw for shop use

place on the pins the handle is turned around until the blade is drawn tightly in the frame. This is accomplished by a screw in the handle of the hack-saw frame which pulls the one pin back when the handle is turned. Most hack-saw frames are made adjustable so that blades of various lengths can be used. In mounting a blade in the frame, the teeth should always point away from the handle, otherwise the saw will cut on the return stroke rather than on the forward stroke.

In cutting metal with a hack saw a firm, well-regulated stroke should be used. The saw should be sent on its forward or cutting stroke aided by considerable pressure applied by both hands. All pressure should be relieved

on the return stroke to prevent the teeth from becoming dull. Many mechanics use a hack saw with such haste and indiscretion that few blades used by them have a chance to become dull before they are broken. In using a hack saw care should be taken to make the blade travel in a perfectly straight line. When the saw is deep into the metal which is being cut any change in the cutting angle will snap the blade. If the blade is pulled too tightly in the frame it will break quickly if the frame is not held accurately while sawing. Many times it is necessary to turn the blade of the hack saw sideways to make certain cuts. This use of the saw is shown in Fig. 65.

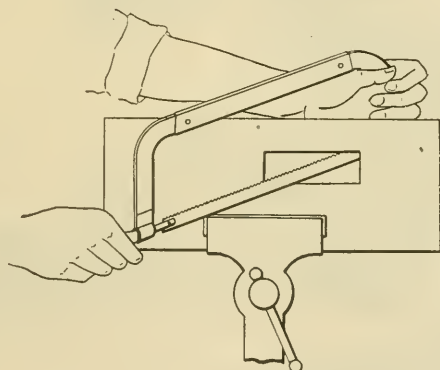

Fig. 65—Using the hack saw with the blade turned sidewise

What is known as a jeweler's hack saw finds a multitude of uses in connection with small, delicate parts. Such a hack saw is shown in Fig. 66. It consists of a very fine blade mounted in a small wire frame. Such a blade can be used for sawing circles owing to its small size. It will also leave a very fine cut where the larger blade will leave a wide ugly cut with burred edges.

Hack saws will cut brass, bronze, cast iron, wrought iron, mild steel, etc. If a metal has a hardness which ap-

proaches that of the blade itself, the blade will not cut it. For all the harder metals such as mild steel, a lubricant should be used on the blade of the saw.

When sawing brass, the strokes should not number over 120 per minute. This number should be reduced to 60 when sawing steel.

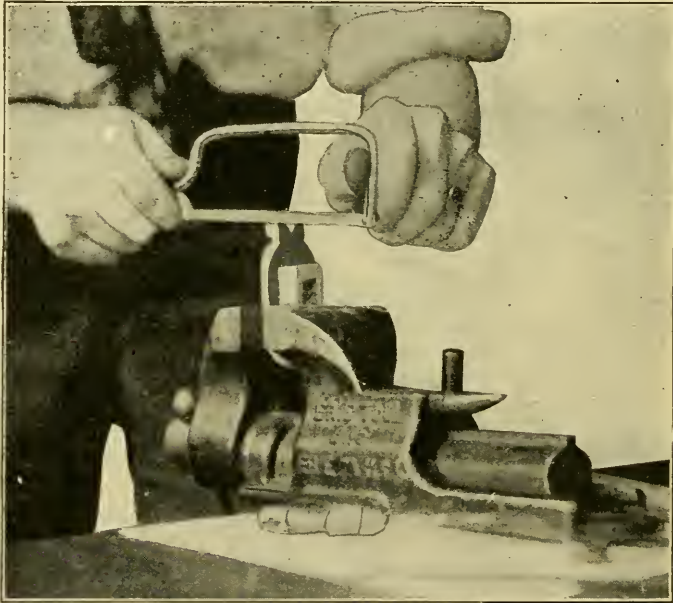

Fig. 66—Slotting with a very small hack saw

A good center punch is a necessity about the shop. The point of the punch should be extremely hard and sharp. If the point is too soft, it will become blunt when used to punch steel or any hard metal. Very good punches can be purchased for a few cents, and, if the mechanic desires, one can be easily ground to shape from an old round file. The point of the punch should be ground at an angle of 60 degrees. During the grinding,

the file should be immersed in cold water occasionally so that it will maintain its hardness. Punches of this type are known as center punches and at least two should be included in the shop equipment. A heavy punch should

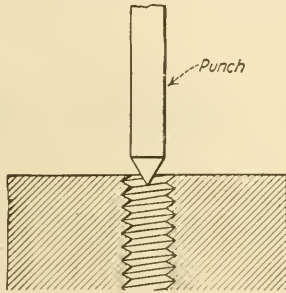

Fig. 67—Setting a screw with a centering punch

be used on work where a large impression is to be made. A small punch should be employed in connection with more delicate parts.

Center punches are used mostly in drilling to mark the

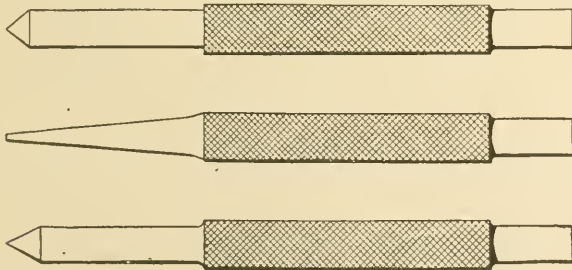

Fig. 68—Different types of centering and driving punches

position where the hole is to be made. They have other uses also, and one of these is shown in Fig. 67. The screw is to be held in place so that it will not become loose. A smart blow with the center punch will spread the end of the screw and prevent it from becoming loose.

Round- and flat-nose punches are needed at times to drive pins and studs in and out. An ordinary pointed center punch cannot be used for this purpose as it will spread the end of the pin. A group of punches for the shop are shown in Fig. 68.

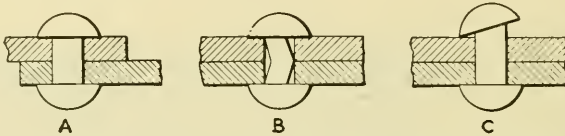

Fig. 69—Properly and improperly placed rivets

A riveting punch has a concave impression at the end. Such punches are used exclusively for rounding and spreading the heads of copper and brass rivets after they are put in place. The proper method of putting a rivet in place is illustrated at A, Fig. 69. To set rivets

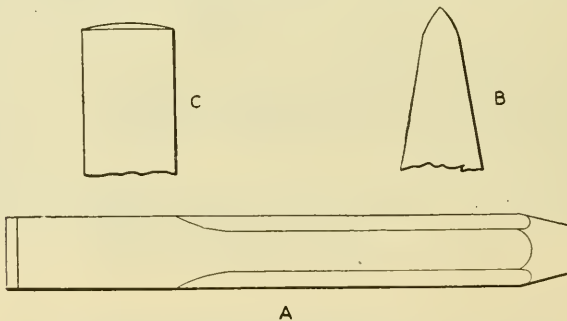

Fig. 70—How a chisel should be ground

properly, the hole in which they are placed should be just the right size so that the rivet will fit snugly. If the hole is too large the rivet will bend as shown at B, Fig. 69. If any great strain is placed upon the rivet thereafter, it will tend to straighten out and this will cause it to loosen. If the end of a rivet is left too long it will

bend over as illustrated at C, Fig. 69. This results in a poor-looking job. The protruding portion of a rivet before it is flattened depends somewhat upon the diameter. In the average case,  $\frac{1}{8}$  in. is sufficient. For very small rivets  $\frac{1}{16}$  in. will suffice.

The chisel is a much-used tool. It is employed in cutting copper, babbitt, lead, brass, steel and iron. It is used largely in removing superfluous metal from rough castings. A common chisel used for ordinary chipping is shown in Fig. 70 at A. It is forged from a piece of octagonal steel with flat surfaces ground about 3 inches back from the cutting edge. The angle of the faces which form the cutting edge varies according to the metal being cut. For soft metals such as copper, babbitt, etc., from 25 to 30 degrees will be found sufficient; for brass and cast iron angles should be from 40 to 55 degrees, while for steel they should be increased to from 60 to 70 degrees. The faces of the chisel should be perfectly flat and not rounded as shown in Fig. 70, B. To facilitate the cutting edge it is ground with a slight curvature as shown in Fig. 70, C.

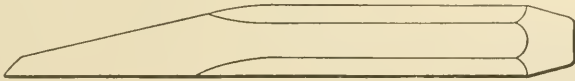

Fig. 71—A special type of chisel used on work where it is desired that the tool should not dig deeply under the surface

A special type of chisel is shown in Fig. 71. This is used in cases where it is desired to have the chisel follow a nearly parallel line to the surfaces of the work.

The chisel shown in Fig. 72 is known as a diamond-point chisel and it is used for squaring corners. It is ground in the same way for use with all metals.

The chisel in Fig. 73 is known as a cape chisel. This

is used principally for cutting grooves. It will be noticed that it has a very flat, narrow nose.

In using a chisel it should be grasped in the full hand with the knuckles held upward. The chisel should not be held too tightly as this will interfere with guiding it.

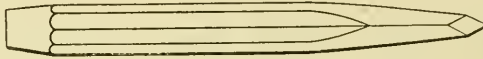

Fig. 72—A diamond-pointed chisel

The grip should just be sufficient to enable the user to exercise perfect control over the course the cutting edge is taking. In actual use the cutting edge of the chisel should be watched rather than the opposite end. The hammer used should have sufficient weight to drive the chisel forward and light hammers are not suitable for

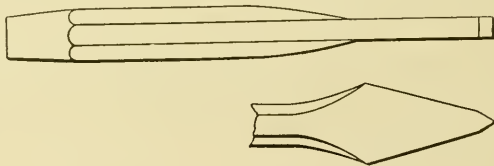

Fig. 73—A cape chisel

this purpose unless the chisel is very small. The chisel should be struck with a light blow first and followed with a heavy cutting blow. The light blow is made to better the aim of the mechanic and to obviate battered knuckles. The proper method of handling a chisel is shown in Fig. 74.

Threads are cut two ways; on the lathe and by means of hand tools. Thread cutting on the lathe will be described in Chapter 5. The present consideration will be limited to hand tools used in the production of internal and external threads. In producing an internal thread



what is called a tap is used. Several large taps are shown in Fig. 75. These are made of extremely hard steel with a definite diameter. A certain sized drill must be used with each tap and taps of certain makes have the drill



Fig. 74—Using a small chisel in removing superfluous metal from a small casting

size stamped upon the shank. For instance, an  $8/32$  tap requires a No. 28 drill. In using the tap, a hole is drilled with the No. 28 drill to the proper depth. The tap is then inserted in a tap wrench (Fig. 76). The point of the tap is then placed in the hole and pressed firmly down

with a twisting motion. In doing this the tap must be held as straight as possible or otherwise the threads will be inaccurate and the screw will not be straight when put in place. After the threads are started, the tap is first advanced and then the direction is reversed for a revolution or two to relieve the strain on the tap. For every revolution the tap is reversed, it is advanced three or four. This is continued until the tap reaches the end of the hole, or, if the hole is completely through the work, until the tap protrudes sufficiently at the opposite end. If the direction of the tap is not reversed frequently a

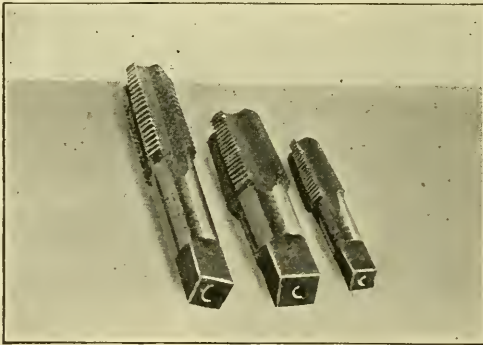

Fig. 75—Three large hand taps of different size

great strain will be imposed upon it and it will probably snap in two before it is advanced very far. Taps are extremely brittle and they must be handled with great care. This is especially true of the smaller sizes. After the mechanic has used a tap a number of times, his fingers will become sensitive and he will know at just what point to reverse the tap. The proper size drill should always be used as a too-large drill will result in thin threads and a too-small one will break the tap. What is known as a drill gauge can be used to determine the

proper size drill to use for all sizes of taps. A drill gauge is shown in Fig. 77. Each hole in the gauge represents a drill of a certain size and beside this hole is a corresponding tap number. For instance, opposite the hole marked No. 28 will be found the number 8/32. When using the tap in connection with steel, a lubricating substance should be employed. Ordinary lubricating oil will



Fig. 76—Using a small tap in a tap wrench

be found suitable for this purpose and the tap should be dipped in it before cutting is started.

A very useful little kink is illustrated in Fig. 78. This is for guiding the taps so they will enter the hole straight. A hole the proper size (not too large) is drilled through a block of wood and this is placed over the hole to be tapped. The tap is then inserted as shown.

The larger taps are made in three different types. These are shown in Fig. 79. The first is known as the

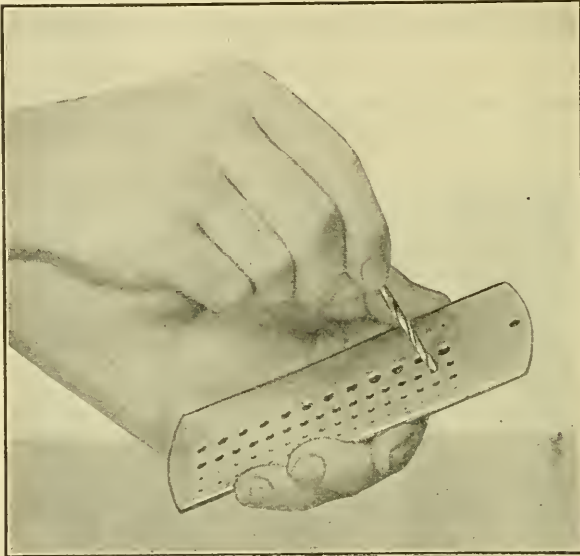

Fig. 77—Determining the size of a twist drill with a gauge

taper tap and this is employed for all ordinary purposes. The second one is known as the plug tap and it will be noticed that it has a very small taper. The third type

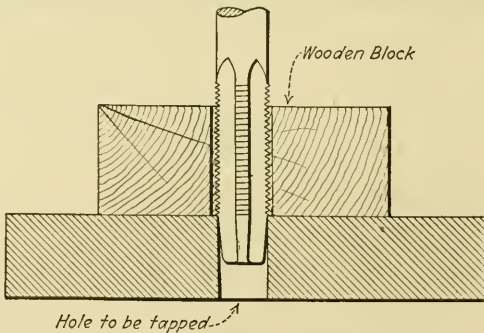

Fig. 78—How a wooden block is used to guide a tap

is known as a bottoming tap and it has practically no taper except on the first thread. The use of the plug

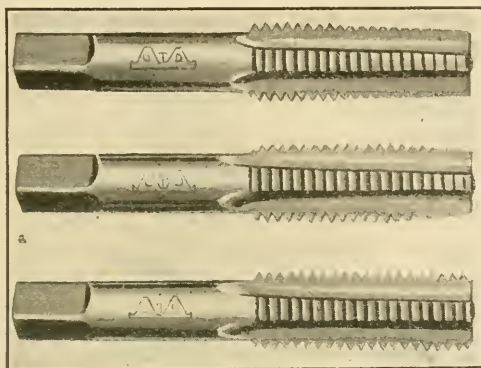

Fig. 79—A taper tap is shown at the top. The center shows a plug tap and a bottoming tap is illustrated at the bottom

and bottoming tap will become evident upon referring to Fig. 80. Here it will be seen that the taper of the

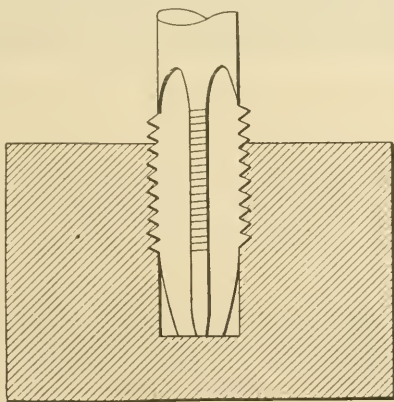

Fig. 80—A taper tap will not cut threads to the bottom of the hole

taper tap prevents it from producing threads in the bottom of the hole. In such a case, the threads would be

started with a taper tap and after this was taken out the plug tap would be inserted and run as far as possible. If it was desired to continue the threads directly to the bottom of the hole, the bottoming tap would be used after the plug tap was removed. The taper is placed on a tap to relieve the strain on the threads. For this reason if the plug or bottoming tap should be used first a tremendous strain would be imposed upon the threads of the tap which would cause them to break.

Some taps are made with a shank smaller than the

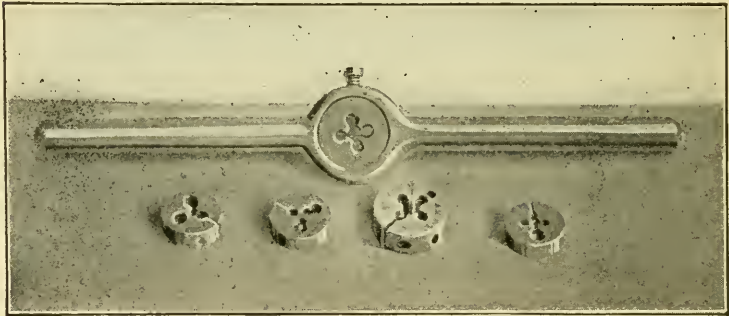

Fig. 81—A die stock and a number of small dies used with it

diameter of the cutting portion. Such a tap can be run completely through a hole. Some taps, however, are not made in this way and the shank is larger than the cutting part.

Taps should be well taken care of. They are very susceptible to moisture and for this reason should be dipped in lubricating oil or vaseline before they are put away. This protects them from moisture and the consequent rust which causes them to become dull and useless.

Dies are used in producing external threads. A set of small dies is shown in Fig. 81. If it is desired to put a

thread upon a rod a die is used. For instance, if it was desired to make a screw that would fit the threads left in a hole drilled with a No. 28 drill and tapped with an 8/32 tap, an 8/32 die would be used to cut the threads on the rod. In doing this, the die must be held in what is known as a die stock. A die stock with a die in it is shown in Fig. 81. The die is held in the stock by means of a small set screw which is tightened with a screwdriver after the die is put in place. Upon examining the die, it will be noticed that it has an internal taper at one side. This side is placed upon the rod to be threaded and with a

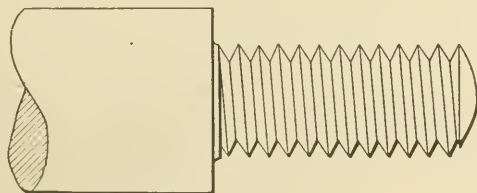

Fig. 82—The method of producing a thread close to the shoulder as shown is described in the text

firm twisting motion and downward pressure the threads are cut upon the rod. To assist the die in cutting, the backward and forward motion is followed as in cutting internal threads with a tap.

If it is desired to cut threads upon a shoulder as shown in Fig. 82, the die should be taken off after it has been advanced as far as possible in one direction and turned around, owing to the fact that the internal taper is on one side only it will be possible to advance the opposite side very close to the shoulder.

Many of the small dies are provided with a screw on their periphery by means of which it is possible to adjust them within a thousandth of an inch. This is done with

a small screwdriver as shown in Fig. 83. In starting a die upon a rod, some caution will have to be exercised in seeing that it is true. If the stock does not revolve in a perfectly true plane, the threads cut will not be accurate and the nut when put in place will be higher on one side than on the other. When steel or wrought iron stock is

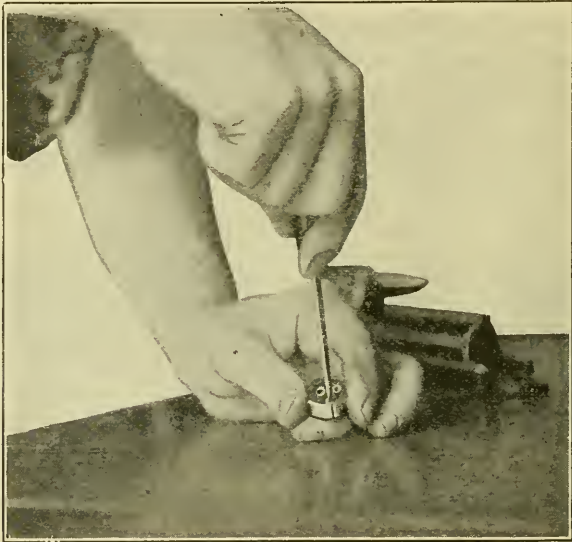

Fig. 83—Adjusting a small die with a screwdriver

being threaded with a small die it should be well lubricated with machine oil. This will not only assist in keeping the threads of the die sharp, but will often prevent them from breaking when under strain. The stock should not be revolving too rapidly, as this causes an undue strain upon the parts. After the threads have been cut, the die can be removed by spinning the stock in the opposite direction. This spinning can be continued until the die approaches the top of the rod upon which the threads have been cut. If it is allowed to spin



until it reaches the top, it will revolve there and in all probability destroy the first thread.

For thread cutting on large rods and pipes larger dies and taps are used. The dies used on such work are generally adjustable within wide limits. This is accomplished by using what is known as the split die, that is, a die which is made in two pieces. The die stock is so arranged that it will hold these pieces in place and means is also provided to adjust the blocks. Such a die stock, together with an assortment of blocks, is shown in Fig.

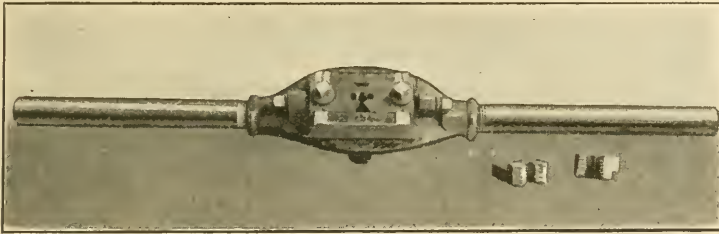

Fig. 84—A split die and die stock

84. Owing to the long handles on such large die stocks, a powerful leverage is produced and it requires very little strength to produce threads on large rods of steel, brass or iron.

Like taps, dies should be well taken care of, and after being used they should be carefully wiped off and smeared with either machine oil or vaseline to protect them from moisture. If the threads become rusted, they will not only lose their sharpness but their size, and therefore become useless.

It is important to have several pair of pliers on hand. At least one of these should be of the wire-cutting variety. A very small pair that can be used in handling small parts should be included. The ordinary wire-

cutting pliers are so arranged that their jaws are at an angle when open. When they are used for purposes other than cutting wire, this is a disadvantage as will be

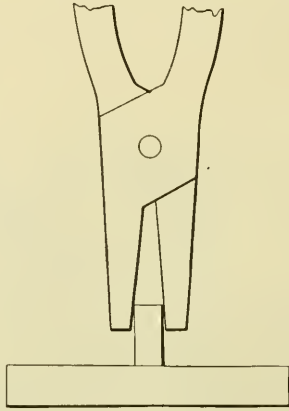

**Fig. 85A**—How the jaws of an ordinary pair of pliers grip a pin seen by referring to Fig. 85A. In removing a stud with such a pair of pliers, the top of the stud will be badly damaged as the pliers merely grip the edges. For such

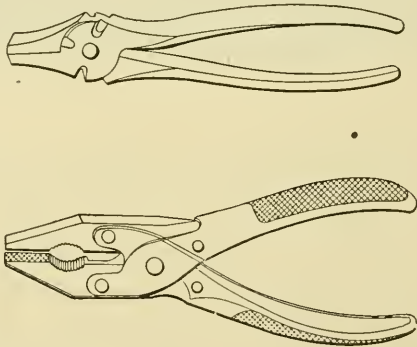

**Fig. 85B**—At the top is shown a pair of ordinary pliers. At the bottom is shown a pair of parallel jaw pliers

work, what is known as parallel jaw pliers should be used. Such a pair of pliers is shown in Fig. 85, B. The

parallel jaw pliers are so made that their jaws will open parallel to one another, and owing to the large contacting surfaces a very powerful grip is produced. The wire-cutting pliers have two sharp edges and the sides of

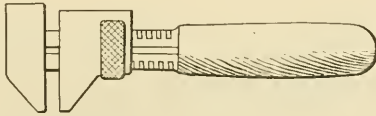

Fig. 86—An adjustable wrench

these are used for cutting wire, small pieces of brass stock, etc.

Like pliers, wrenches are much-used tools, in tightening and loosening bolts, holding stock, etc. A good type

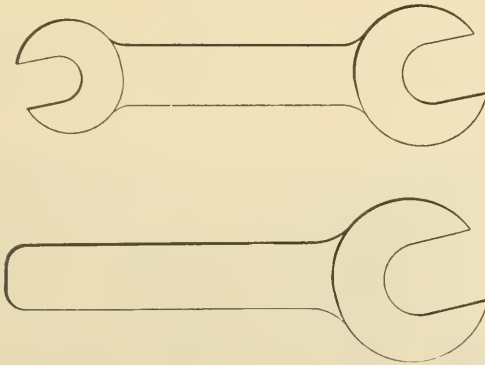

Fig. 87—Two types of non-adjustable wrenches

of wrench is shown in Fig. 86. It will be noticed that only one jaw is adjustable and this is moved by means of the knurled nut which has internal threads that engage with the rods upon which the one jaw slides. At least two wrenches should be included in the equipment of the shop. In the average case a medium-size wrench and a small-size wrench will suffice.

Many times use is found for non-adjustable wrenches and if possible it is well to have a set of the smaller size on hand. Owing to the fact that the jaws are immovable there is no play between them and the nut being turned.

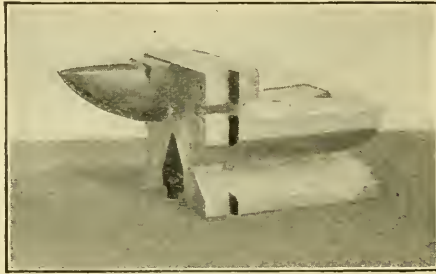

Fig. 88—A small anvil for shop use

This reduces the possibility of the wrench slipping off the nut to a minimum. No matter how well made, adjustable jaw wrenches have some play and when they



Fig. 89—How a piece of sheet metal is bent on a small anvil

become worn they are very apt to destroy the corners of small hexagonal bolts by slipping around. Once a wrench slips in this way it rapidly degenerates into a nuisance.

Non-adjustable wrenches are made in two styles; double end and single end. One of each type is shown in Fig. 87.

An extremely useful little device is shown in Fig. 88. This is a small bench anvil and it will find a multitude of uses. These anvils are manufactured with perfectly true surfaces, well hardened and with milled grooves and slots. The flat surfaces of the anvil on the top are used for straightening work which has sprung. The edges are very useful in bending sheet metal at right angles. If it

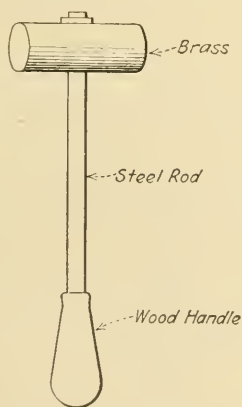

Fig. 90—A brass hammer

is desired to bend the metal perfectly square and true one of its edges should be placed against the edge of the anvil with the end, overlapping at the side the proper distance. This is illustrated in Fig. 89. The horn of the anvil is used in circular work.

In bending soft brass stock over the anvil it is best to use a hammer that will not mar the surface. Such a hammer can be made from a piece of round brass stock provided with a handle. A hammer of this kind is shown in Fig. 90. It is also well to have a real heavy hammer made of lead to use with soft materials. If a pin is to

be driven in place and the worker wishes to keep it in shape the lead hammer will be found to work very effectively.

The small clamps shown in Fig. 91 are used for a multitude of purposes about the shop. For instance if two

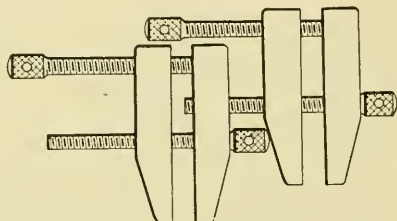

Fig. 91—A pair of small clamps which find a multitude of uses about the small shop

pieces are to be soldered together they can be held in the clamps during the operation, or, if a piece of stock is to be drilled it can be conveniently held in the clamp while the drilling is done. There are many other instances where such clamps can be used.



Fig. 92—A letter punch used on metal

Metal stock can be marked with letters by the aid of special steel punches which have the letters and figures formed in their end. Such a steel punch with a hand cut steel letter in the end is shown in Fig. 92.

## CHAPTER III

### Measuring Instruments and Their Use

The standards of measurement—American standards—The scale—The square—Use of the square—Adjustable squares—Calipers—Inside calipers—Outside calipers—Shoulder calipers—Use of different types of calipers—Odd measurements made with calipers—Dividers—Use of dividers—Marking out with dividers—The micrometer—Construction of micrometer—How to read a micrometer—How to take care of a micrometer—Micrometer vernier—Micrometer vernier and how to read it—Vernier calipers—How to read vernier calipers—Use of vernier calipers as height gauge—Surface gauges—Use of surface gauges—Surface plates—Marking out with surface plates—Protractors—Use of protractors in marking out—Use of miscellaneous measuring tools.

THE accuracy of a mechanic's work generally depends upon his ability in manipulating measuring tools. The author regards this particular phase of mechanical shop practice of sufficient importance to devote a complete chapter to, and in the following lines the reader will find enough information and data to enable him to use mechanical measuring instruments intelligently. The importance of this cannot be over-estimated. When the author was a lad, a seasoned old mechanic happened to see him trying to use his eye in place of a measuring instrument. He well remembers how the old man reprimanded him for trying to substitute his eye for a more accurate measuring tool. The lesson was never forgotten.

The most widely used unit of measurement in the United States is the inch. On the Continent the millimeter is used entirely, and, in fact, in some industrial

institutions in the United States, it is used to some extent. Few measuring instruments are manufactured in this country that measure in millimeters, and for this reason the inch and its parts alone will be considered in this treatment.

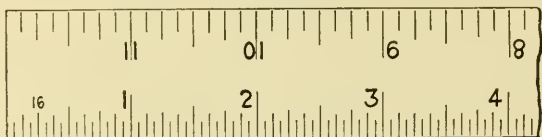

Fig. 93—Section of a small scale

The scale is the most important measuring tool and the amateur mechanic must learn to use it properly before he can hope to master the more complicated devices. The scale is really a ruler in common terms with the

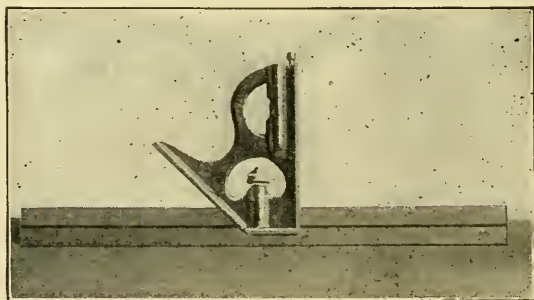

Fig 94—An adjustable machinists square and level combined

divisions engraved on a piece of steel. Scales are procurable from two inches to one foot in length. The divisions are marked off very accurately. A scale has each of its four edges engraved. One edge is subdivided into sixteenths of an inch; one into thirty-seconds; one into sixty-fourths and one into one-hundredths. The smaller divisions are only used when necessary. All



common measurements such as  $\frac{1}{4}$ ,  $\frac{3}{8}$ ,  $\frac{1}{2}$ ,  $\frac{3}{4}$ , etc., are measured with the 16ths scale. Thirty-seconds can be read off very easily, but it requires very good eyesight when measuring in 64ths or 100ths. The 100ths of an inch is the smallest division employed upon scales as it would be impossible for the eye to discern a smaller subdivision. A 6-in. scale is shown in Fig. 93.

A square is a much-used instrument about the shop, and furthermore it is an absolute necessity. An adjustable square is shown in Fig. 94. It will be seen that it embodies a scale sliding in a holder. The scale has a groove in its center and by means of a knurled nut it is possible to lock the square in any position. In determining whether or not a piece of work is square the square should be applied as shown in Fig. 95. The worker should always face the light when making this determina-

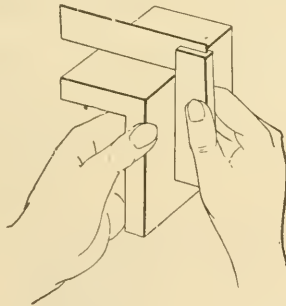

Fig. 95—The use of the square

tion and if a perfectly true surface is desired it should be scraped or ground until absolutely no light can be seen between the edge of the square and the surface of the work. Non-adjustable squares are also made, and one of these is shown in Fig. 96. In measuring small pieces it is very convenient to use such a little square as it is possible to rest the work against the square as shown in

Fig. 97. These squares can also be used in other ways as will be explained later.

Calipers are very simple instruments and yet they require a certain amount of skill to manipulate them properly. A simple pair of calipers consists of two arms riveted together at one end in such a way that they will move upon the rivet as an axis. Hence they can be used to measure round pieces of work and other odd shapes

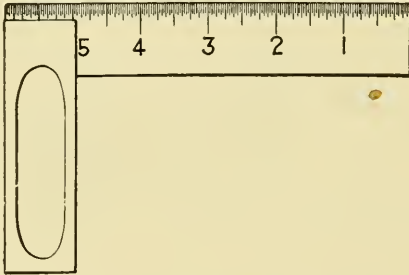

Fig. 96—A non-adjustable square

where it would not be practical to employ an ordinary scale. The use of a simple pair of calipers is shown in Fig. 98. The jaws of the calipers are opened until they will just slide over the metal. The measurement of the

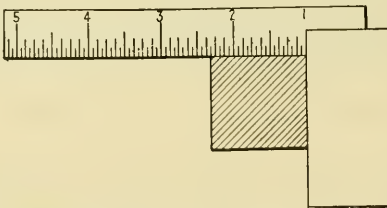

Fig. 97—Measuring and squaring at the same time

stock is then found by applying the calipers to a rule as shown in Fig. 99. If a piece of work is to be turned down in the lathe to a diameter of 2 in. the calipers are first set with the scale. They are then applied to the

work at regular intervals until sufficient metal has been turned away to make a diameter of two inches. The use of calipers may appear very simple but it will be found

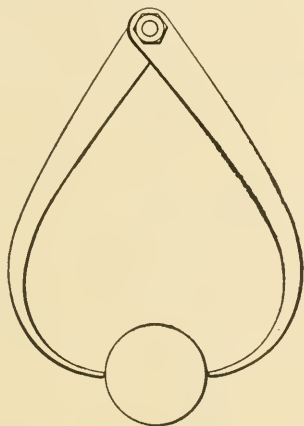

Fig. 98—The use of calipers in determining the diameter of a rod upon actual use that it is not an easy matter to make an accurate measurement with calipers unless they are

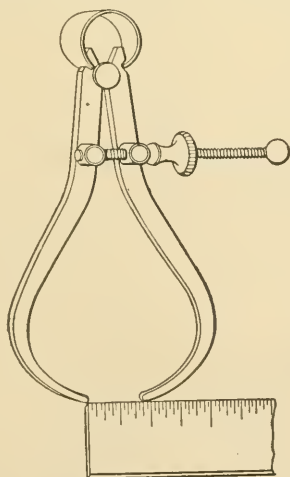

Fig. 99—Setting calipers with a scale

handled with caution. It may be possible to produce a shaft approximately 2 in. in diameter but making it exactly 2 in. is quite another matter. It is true that extremely accurate measurements can be made with calipers but there are many mechanics who are so accustomed to their use and who have developed such sensitive fingers that they can make measurements within the 1/1000th part of an inch. When a mechanic applies calipers to his work he should pull them back and forth several times to determine whether or not there is just the proper fit. If they do not pull over the work freely they should never be forced as this will cause the jaws

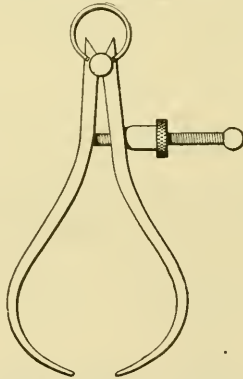

Fig. 100—A pair of calipers that are adjusted with a nut and screw

to open slightly and an inaccurate measurement will result. In adjusting the calipers shown in Fig. 98 it is customary to tap one jaw on the bench until it closes to the proper distance. This instrument is known as an outside caliper owing to the fact that it is employed in making outside measurements.

The caliper shown in Fig. 98 is a somewhat antiquated style and it is largely replaced to-day by the more improved type shown in Fig. 100. This is called a spring

caliper and it can be very accurately adjusted by means of a thumb nut. Once adjusted there is no danger of it losing its adjustment through careless handling unless the nut is turned.

Inside calipers are shown in Fig. 101 and their use in

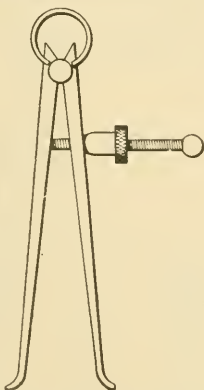

Fig. 101—A pair of inside calipers with fine adjustment

making an internal measurement is shown in Fig. 102. Inside calipers are adjusted by means of a square as

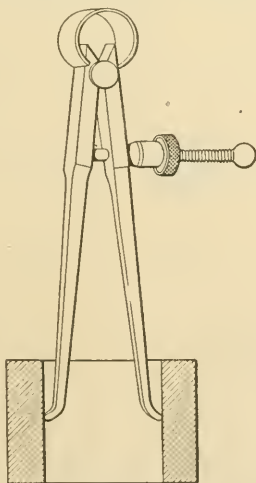

Fig. 102—How inside calipers are used

shown in Fig. 103. The calipers should never be forced inside a cylinder or other piece of work, as this will cause them to spring. In using calipers they should be applied to the work very lightly.

What is known as a shoulder caliper is shown in Fig.

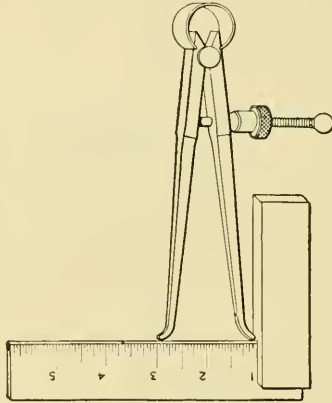

Fig. 103—How inside calipers are adjusted with a small square

104. Such calipers, however, will not be absolutely necessary as a scale can be conveniently used in their stead.

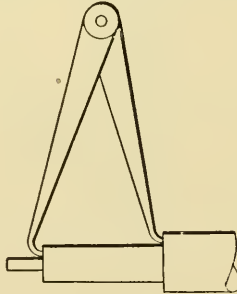

Fig. 104—This shows the use of shoulder calipers

A special use of outside calipers in measuring the wall of a tube with a shoulder is shown in Fig. 105. After the calipers are removed, the distance between the points

is measured and the difference between this and the distance from the outside wall of the cylinder to the calipers' point is the thickness of the wall.

The micrometer, as its name implies, is an instrument which is capable of making measurements up to 1/10000th of an inch. Referring to Fig. 106, which is a drawing of a micrometer, it will be noticed that there are two scales,

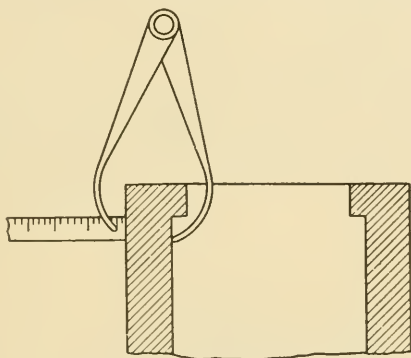

Fig. 105—How the wall of a cylinder with a shoulder can be measured

one upon the movable thimble which either advances or recedes, according to the direction it is turned, and the other at right angles to this upon the arm that projects from the jaws. The screw which causes the jaws of the

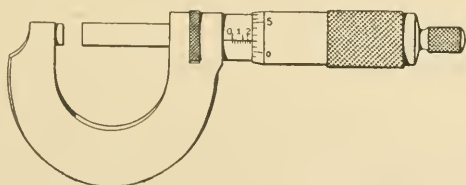

Fig. 106—A micrometer with ratchet attachment

micrometer to move either backward or forward has a pitch of 40, meaning that one revolution of the thimble will cause the movable jaws to either advance or recede 1/40th of an inch, depending upon the direction it is

rotated in. The horizontal scale is divided into 40 parts so that every revolution of the thimble will cause the spindle to move a distance of one of the divisions upon the scale. As  $1/40$ th of an inch is equivalent to .025 of an inch, every one of the divisions on the horizontal scale is equivalent to this, and measurements are made in the decimal part of an inch rather than in common fractions. It will be seen that by moving the thimble from 0, or the point at which the jaws are closed, to 5 on the horizontal scale it will cause the spindle to open to .500 of an inch or  $1/2$ . Causing the spindle to open to 6 will cause the jaws to be .600 or  $3/5$ ths of an inch apart.

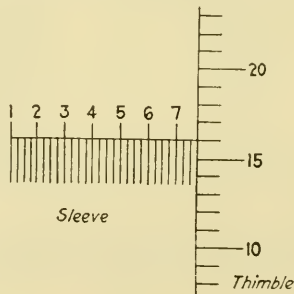

Fig. 107—A micrometer reading of .766

This is, of course, assuming that the thimble makes 24 complete revolutions (from the closed or zero position), as every revolution is equivalent to .025 and therefore  $24 \times .025$  will be .600. To make a complete revolution of the thimble it is necessary to bring it to the zero mark and revolve it until it comes back to this mark. Counting from "0" back to "0" the thimble scale is divided into 25 equal parts and if this thimble either advances or recedes .025 of an inch for every revolution, it will only move  $1/25$ th of this or .001 of an inch for every one of the divisions marked on the edge of the thimble. Thus,



it will be seen that such an instrument can be used to measure as close as .001 of an inch with accuracy, and, if the user's eyesight is good .0001 of an inch can be approximately arrived at by determining just how far the mark of the thimble is from the horizontal line on the other scale. There is a vernier attachment which makes this possible. This will be described later. The micrometer is very easy to read if the user will keep in mind the fact that a complete revolution causes it to move  $1/40$ th of an inch and that the thimble is graduated in 25ths which would make  $1/25$ th of a revolution represent  $1/25$ th of  $1/40$ th or  $1/1000$ th of an inch.

Most micrometers are provided with a scale on the

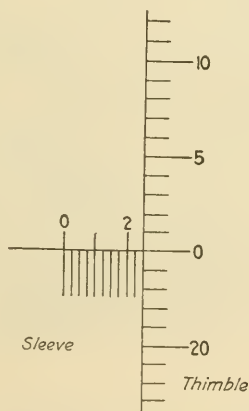

Fig. 108—A micrometer reading of .250

side which gives the decimal fractions of all common fractions such as  $1/4$ ,  $1/2$ ,  $3/4$ ,  $1/8$ ,  $3/8$ ,  $5/8$ , etc. The reading of a micrometer can be reduced to a common fraction by merely placing it over 1000 and reducing it as far as possible. If the micrometer is opened two divisions beyond 7 on the horizontal scale with the thimble at the 16th division as shown in Fig. 107, the reading will be

.766. The second point beyond 7 on the scale would represent the 30th division and since each division is equal to .025 of an inch, 30 would be equivalent to  $30 \times .025$  or .750. To this is added the .016 made by the thimble advancing over the point of  $16/25$ ths of a revolution, or, in other words, .016 of an inch. A micrometer reading  $\frac{1}{4}$ th of an inch or .250 is shown in Fig. 108.

Ordinary micrometers are seldom used in shop practice where duplicates of exactly the same dimensions are made. This is because of the fact that one man is very

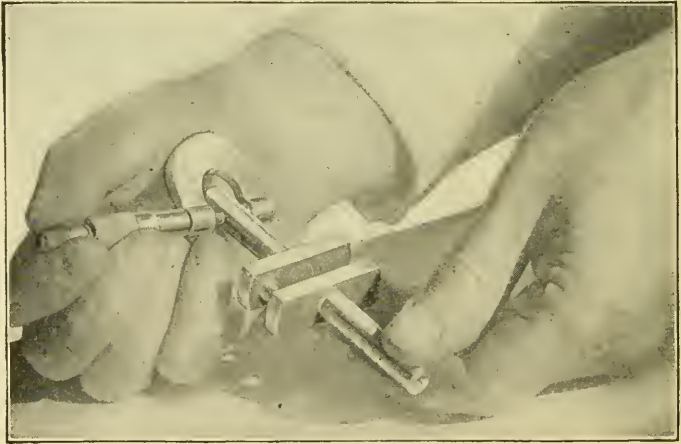

Fig. 109—The proper method of holding a micrometer

apt to screw the micrometer more tightly than another and therefore inaccuracy in the parts will result. This has been overcome to a great extent with a ratchet attachment which allows a definite adjustment of the same tension on all instruments. With a little practice in the use of the micrometer, a mechanic will be able to read one quickly and accurately. If the micrometer is not provided with a ratchet adjustment the user must not screw the jaws too tightly on the work being measured. This

will not give an accurate reading, and, furthermore, it is bad for the micrometer. As they are such accurately made tools, it is necessary to take care of them in order to preserve their accuracy. After the micrometer is used it should be placed in its case where it will not come in contact with other tools. The greatest care should be used to prevent moisture from getting on the surfaces of the jaws, as this will cause rust and when the rust is removed it will seriously impair the accuracy of the device.

The proper method of holding a micrometer is shown in Fig. 109. It will be seen that the thimble and ratchet

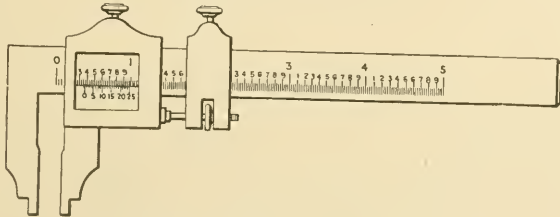

Fig. 110—Vernier calipers

is turned with the thumb and the index finger while the opposite end of the micrometer rests in the palm of the hand. The work being measured is held in the other hand.

The vernier caliper is often used in place of the ordinary micrometer. With this instrument it is possible to make a wider range of measurements. The ordinary small micrometer seldom measures over 2 inches between the jaws when they are opened to the maximum distance. A vernier caliper is shown in Fig. 110. It will be seen that the instrument consists of two jaws, one which is stationary and the other which is sliding on a scale. Measurements as small as  $1/1000$ th of an inch

can be made with this device and by adjusting the movable jaw on the scale it is possible to make measurements up to 5 in. with absolute accuracy.

Fig. 111 shows how the vernier works. The scale of the tool is graduated into 40ths of an inch. The scale on the vernier plate is divided into 25 parts, and these 25 divisions occupy the same space as 24 of the divisions on the stationary scale. The difference between one of the 25th spaces and one of the 24th spaces is  $1/25$ th of  $1/40$ th, or, expressed decimally, .001 of an inch. In order to read the instrument, note the number of inches, 10ths and 40ths, the 0 mark on the vernier is from the 0 mark

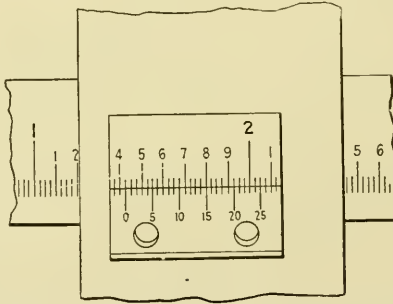

**Fig. 111—How the vernier functions**

on the scale and then note the number of divisions on the vernier from 0 to a line which exactly coincides with a line on the scale. Referring back to Fig. 110 it will be noticed that a very fine adjustment can be made by the little thumb screw which is held in a separate part of the vernier. Both this part and the vernier itself can be held in place by a set screw at the top when the proper adjustment has been made. The vernier can be used as a height gauge by the attachment shown in Fig. 112. This attachment can also be used in measuring the height of recesses and shoulders.

What is known as a micrometer depth gauge is shown in Fig. 113. With this instrument it is possible to accurately determine the depth of a hole by inserting the spindle with the shoulder or cross piece resting upon the work. When in this position the thimble is turned until the spindle reaches the bottom of the hole.

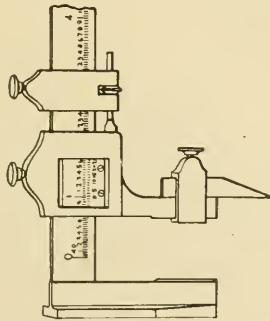

Fig. 112—A vernier caliper in use as a height gauge

A surface gauge is a very important tool which is used in marking out work to be machined. Such a gauge is illustrated in Fig. 114. It will be noticed that it consists

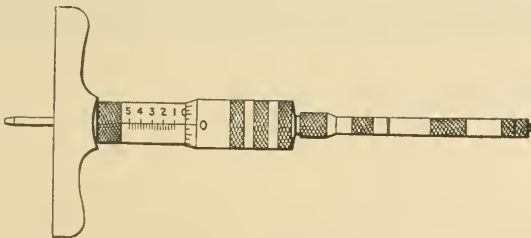
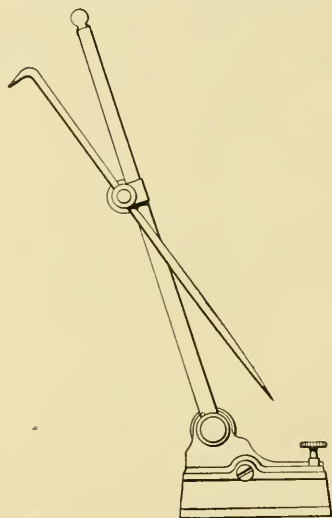

Fig. 113—A micrometer depth gauge

of a base, standard and a scriber or sharp-pointed steel rod straight at one end, bent at the other and so fixed that it can be moved up and down the standard. It will also be noticed that the bottom of the standard is provided with a thumb screw and by means of this thumb

screw it is possible to cause the standard to be set at different angles. The surface gauge must be used with what is known as a surface plate. This is a hand-scraped steel plate which is made with a very smooth surface



**Fig. 114—A surface gauge**

mechanically true in every respect. Without such a plate a surface gauge is of little value as wide variations in measurement will be caused by using it on inaccurate

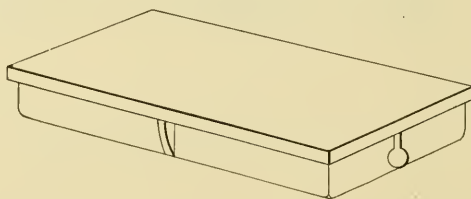

**Fig. 115—A surface plate for use with the surface gauge**

surfaces. The surface gauge is adjusted as depicted in Fig. 116, and its use in marking the height of the port-holes in a model compressor cylinder is shown in Fig.

117. The scribe is made of hardened steel and therefore it will scratch iron, steel, brass and all the softer metals. If the portholes on the model cylinder shown in Fig. 117 were to be  $1\frac{3}{4}$  in. from the base, the surface gage would be adjusted to this height by means of the screw. The instrument would then be grasped in one hand and the cylinder held in the other. By sliding the gauge across the surface plate with the pointer in contact

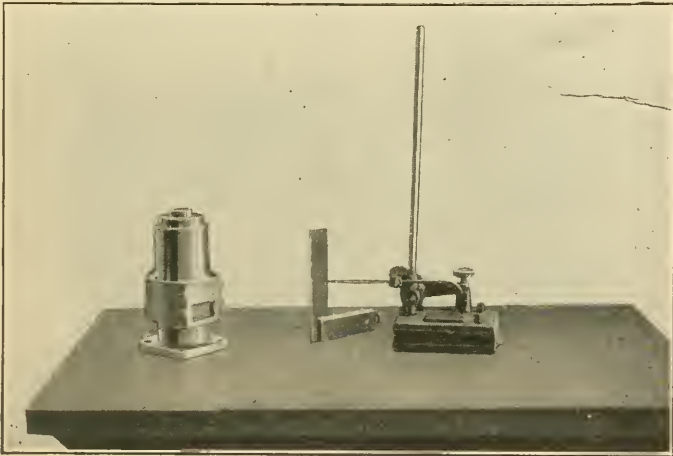

Fig. 116—Adjusting the surface gauge with a small square and scale with the cylinder a distinct scratch will be made in the proper place on the cylinder.

Surface plates are very expensive and it is necessary to take very good care of their surfaces. Moisture will cause a surface plate to deteriorate rapidly, and for this reason it should be smeared with machine oil or vaseline after it is used. This can easily be removed with a cloth soaked in gasoline. The manufacturers of these surface plates also provide a cover which is placed over them when not in use. This is to prevent their surfaces from becoming marred by accident.

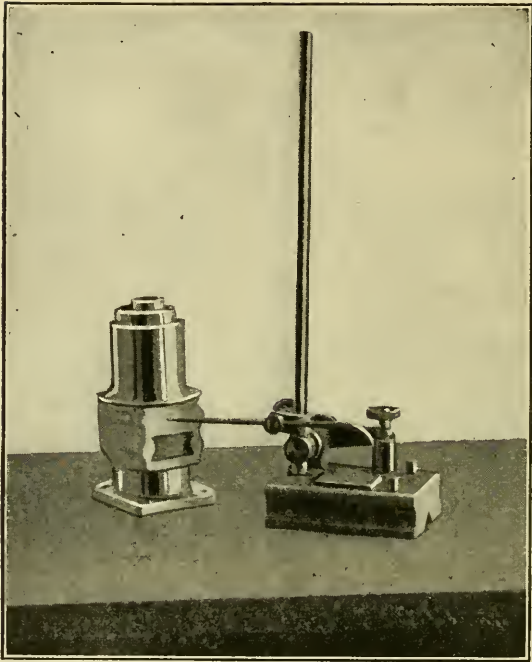

Fig. 117—Scratching a line with the scribe of the surface gauge

Not every amateur mechanic can afford surface plates or expensive surface gauges. A very good substitute for a surface gauge is shown in Figs. 118 and 119. This is a home-made affair, and, although not as accurate as a

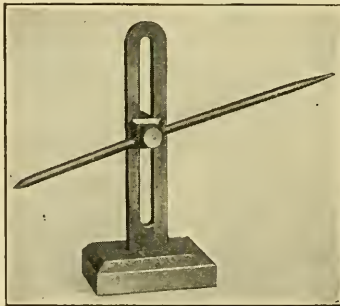

Fig. 118—A simple, home-made surface gauge



commercial instrument, it will suffice for ordinary work. In place of an expensive surface plate this little instru-

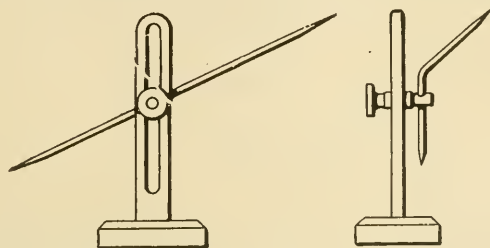

Fig. 119—Drawing of the simple surface gauge shown in Fig. 118  
ment can be employed with an ordinary piece of plate glass.

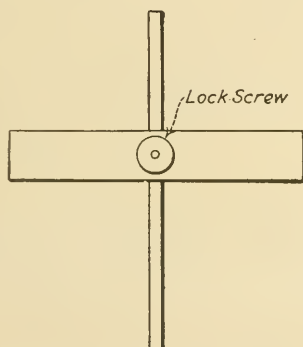

Fig. 120—A simple, home-made depth gauge

Like the surface gauge, a good substitute for an expensive depth gauge can easily be made. Such a little instrument is shown in Fig. 120.

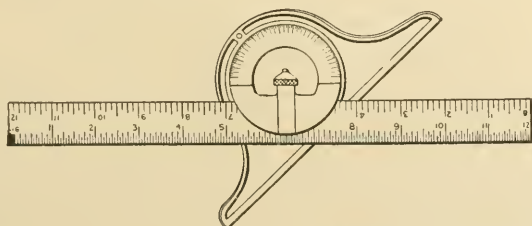
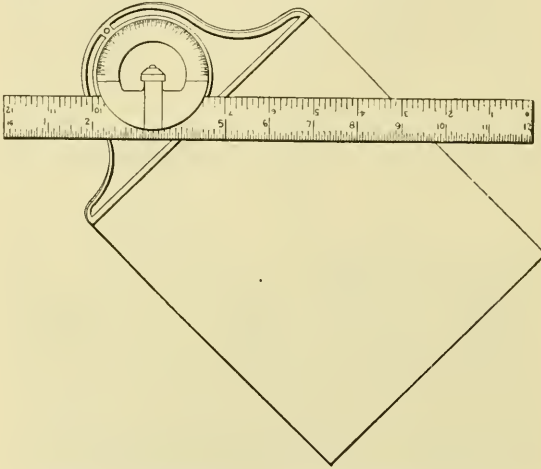

Fig. 121—A combination scale, square and protractor

The instrument shown in Fig. 121 is known as a protractor and it is used largely in marking out work for machining. It will be seen that the scale can be adjusted to any angle between 1 and 180 degrees. If it was desired to make a line at a certain angle on a piece of square



**Fig. 122—Showing one use of the protractor**

work, the protractor would be held on the work as shown in Fig. 122.

A very useful addition to an ordinary scale is shown in

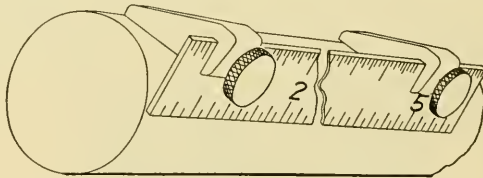

**Fig. 123—A key-way scale and its use**

Fig. 123. The two small blocks attached to the scale are known as key rule blocks and by their aid it is possible to lay out a straight line upon a circular piece of work. If the rule is used without this it is not known whether the line is straight or not.

## CHAPTER IV

### Drilling and Reaming

Laying out and marking work—Twist drills—Operation of twist drills—How to properly sharpen twist drills—Twist drill sizes—How to sharpen very small twist drills—Drill presses for the small home shop—Operation of drill press—Different types of drill presses—Power drill presses—Hand drill presses—The process of drilling—Finding the center for a large drill—Drilling different metals—How to sharpen the drill for brass—How to sharpen drill for iron and steel—Speed of twist drill for the different metals and different sized drills—Vee blocks—Use of Vee blocks in drilling holes in circular pieces—Fly cutter—Use of fly cutter—How to make a fly cutter—Bottoming drill—Use of bottoming drill—Countersink—Producing square holes—Use of drift—Construction of drift—Reamers—Use of reamers—Sharpening reamers—Burring reamers.

DRILLING is one of the most essential and important operations carried on in the shop. Knowing how to drill accurately and properly is necessary in the construction of practically everything the amateur mechanic makes.

Unless holes are to be drilled promiscuously, measuring and marking is the first operation necessary in producing holes in a piece of work. Two of the most important tools used in marking out work for drilling, aside from those described previously in Chapter 3, are a pair of dividers and a scribe. These are shown in Fig. 124.

The brass plate depicted in Fig. 125 is to be drilled as shown. It will first be necessary to find the center of the plate. A prick-punch mark is placed at each end of the plate in the center and the line A (Fig. 126) is then drawn. The two lines BB are then drawn through this

center line. Where these lines cross a prick-punch mark is made. The dividers are then opened  $\frac{3}{32}$ nds of an

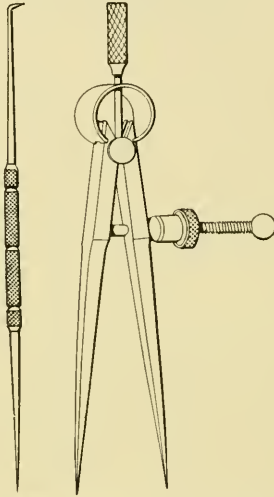

Fig. 124—A pair of dividers and scribe used in marking out work inch, and with one leg placed on the edge of the plate and the other leg in contact with the top surface, the line C

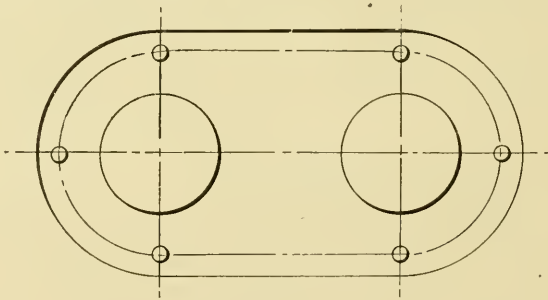

Fig. 125—Method of marking out for holes to be drilled

is drawn all the way around. Distances for the small holes around the edge are then marked off and an indentation is made at the proper point with the prick-punch. The dividers are then used in drawing the small circles shown at the point where the prick-punch mark is made.

The outer circle represents the exact dimension of the hole to be drilled, while the inner circle is used in guid-

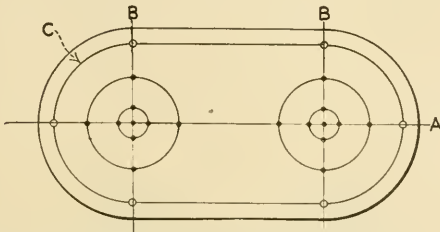

Fig. 126—How marking is done for the drilling of large holes with a twist drill

ing the drill as will be explained later. The same procedure is followed with the large holes.

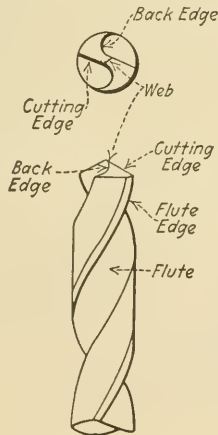

Fig. 127—The twist drill and the names of its various parts

Before going farther with the drilling operation it will be well to thoroughly understand modern twist drills and their operation. A twist drill and the names of its various parts is shown in Fig. 127. It will be seen that the cutting or forward edge is slightly higher than the back edge. The difference in this height is called the clearance

and it must be the same on both sides of the drill. Otherwise the drill will not cut accurately but will function as shown in Fig. 128. The cutting edge of a drill is gen-

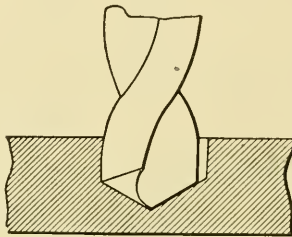

Fig. 128—How a twist drill produces a larger hole than its diameter when it is improperly ground

erally 60 degrees for ordinary work and when grinding the drill the little instrument illustrated in Fig. 129 is used to guide the work. Of course it will be understood that such a gauge could not be used on a very small drill.

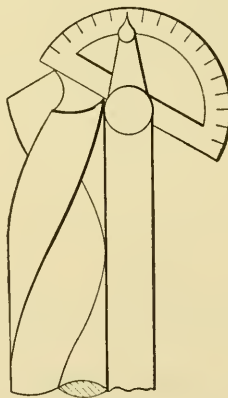

Fig. 129—The use of a protractor in grinding a large drill

In using the gauge it should be applied to both sides so that they will both be ground at the proper angle. The flute of the drill is a valley cut spirally the whole length

of the drill. The web is that portion in the center which separates the flutes.

Before the mechanic sharpens his first drill he should make a careful study of the cutting edges of new drills. Manufacturers place drills upon the market perfectly ground, and for this reason no mistake can be made in trying to reproduce their grinding. Drills should be sharpened on grinding wheels and when doing this they should be held in both hands as shown in Fig. 130. It will be noticed that the drill is really held in one hand and guided with the other. Its edge should be applied

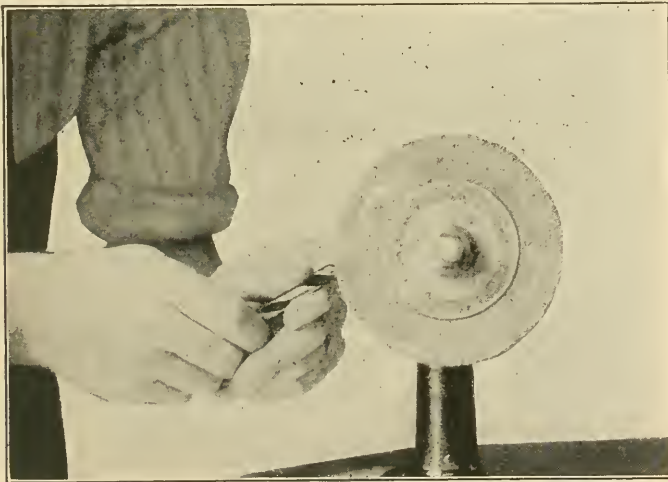

Fig. 130—The proper method of holding a drill during grinding

very lightly to the wheel. When it is touched to the surface of the wheel it should be revolved for about  $\frac{1}{2}$  revolution with a sweeping motion upward. Care should also be taken to hold the drill at the proper angle on the wheel. Of course, this can only be approximate, but nevertheless, a trained eye will reduce the inaccuracy to

a minimum. If a large drill is being ground on a wheel with a small face (width) it can be ground on the side of the wheel.

In sharpening a drill it will be necessary to keep it cool, otherwise its temper will be effected and the cutting edge will become soft. To prevent this, the point of the drill should be dipped repeatedly in a convenient receptacle of cold water. For very small drills, a wheel with a very fine grit can be used but for larger drills a wheel with a coarser grit should be used. Various types of grinding wheels and their use will be outlined in another chapter.

The smaller drills are designated by numbers and they

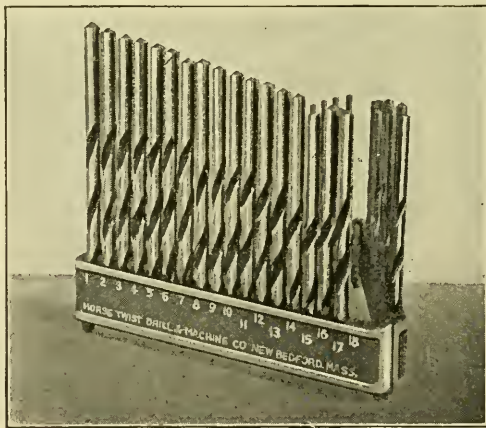

Fig. 131—A complete set of the number drills in a rack

run from No. 1 to 80. They are called the wire gauge drills, and the smallest, which is No. 80, measures about .0135 in. in diameter. The No. 1 wire gauge drill measures  $15/64$ ths of an inch in diameter. The wire gauge drills will suffice for all ordinary purposes and a complete set should be in every workshop. Such a set is shown in Fig. 131. They are held in a triangular rack



and the corresponding number for each drill is beside the hole in which the drill is placed.

It is practically impossible to sharpen the smaller drills (from No. 50 to 80) on a grinding wheel as the

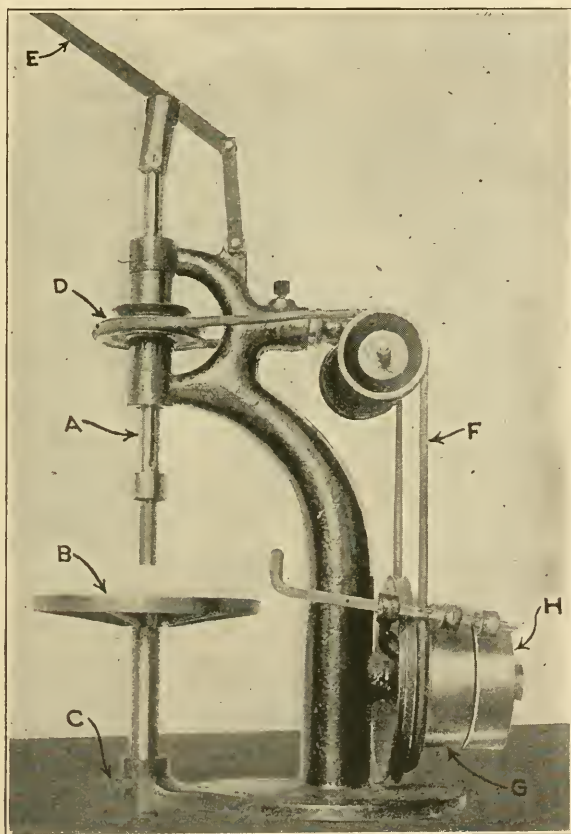

Fig. 132—A power-driven drill press for a small shop

wheel cuts too rapidly. In sharpening such drills it will be found convenient and practical to employ a small magnifying glass and an ordinary little shop abrasive stone.

With this information concerning drills, the mechanic

will be able to proceed with the drilling of the plate mentioned in previous paragraphs. First, a No. 20 drill is selected and placed in the chuck of the drill press. A typical small shop drill press is shown in Fig. 132 without a chuck. The chuck is shown independently at Fig. 133. The chuck is merely a device provided with three

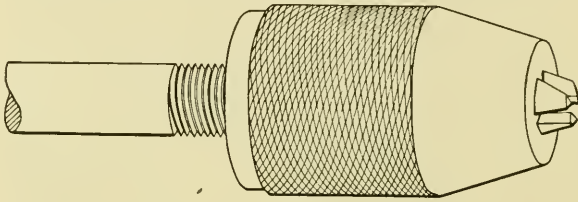

Fig. 133—A small drill chuck

jaws to tighten about the shank or top of the drill and hold it. The drill press consists principally of a spindle which holds the chuck at its end, and a table upon which

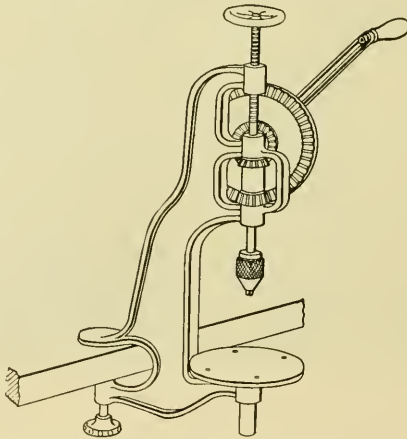

Fig. 134—A small hand-driven drill press

the work to be drilled rests. The spindle in the photograph (Fig. 132) is marked A, and the table or drilling

plate is marked B. The table is adjustable and is held in position by means of the set screw C. The spindle A is provided with a keyway so that the pulley D is able to revolve, carrying the spindle with it and yet the spindle is free to move vertically by actuating the handle E. The driving belt F passes around a large pulley at the back

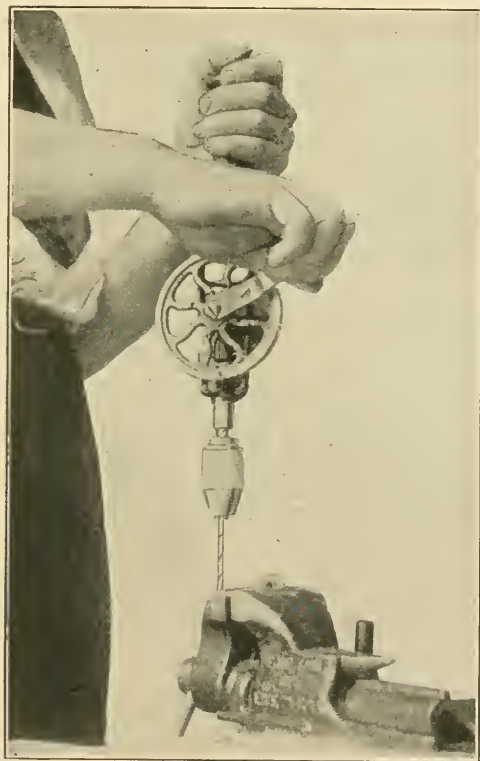

Fig. 135—A hand drill in use

over the two small pulleys above this and around the pulley D at the front of the machine. The flat-faced pulley G is the driving pulley and a belt from this to an electric motor or other source of motive power is con-

nected. By means of the handle I the belt can be shifted from pulley G to pulley H to stop the machine, as the pulley H is what is known as an idle pulley.

Another small drill press of a simple type is shown in Fig. 134. The principal involved is the same, but this machine is hand driven.

What is termed a hand drill is shown in Fig. 135. Such a drill will be necessary in many cases where it is impossible to use a power or vertical drill owing to inaccessibility. In using the hand drill one hand is placed on the handle at the top and the device is driven with the other hand, all the necessary pressure being applied with the hand which grasps the top handle. The one great objection to the use of such a drill is the fact that it is almost impossible to hold it in either a perfectly vertical or horizontal position. When very thin sheet metal is being drilled it is not objectionable if a hand drill is used as it does not matter if the hole drilled is at a slight angle. The use of hand drills is to be recommended for the smaller drills owing to the fact that they are very sensitive and a great amount of breakage is prevented.

Having placed the No. 20 drill in the chuck of the drill press, the plate is placed upon the table and the point of the drill is brought down to the prick-punch mark which was made in the center of one of the larger circles. A very light pressure is applied so that the drill will scarcely cut away the prick mark. The drill is then lifted off the surface of the work and the workman is able to determine whether or not he has struck the center. If the drill has slipped off the prick-punch mark and gone to one side it will be possible to coax it back to the center. If the drill had been allowed to go much deeper, how-

ever, this would have become very difficult if not impossible. Having determined that the drill is proceeding correctly, the point is carried a little farther into the metal. It is then lifted again and if it is still drilling correctly it is returned to the metal and just enough of the metal is drilled away so that the point of the drill will be beneath the surface. The drill is then withdrawn and taken from the chuck after which it is replaced with a  $\frac{3}{8}$ -in. drill. The small-sized drill was used so that the larger drill could be centered properly. The larger a drill is the wider its web will be and the more difficult it becomes to center such a drill. In choosing a small centering drill for a larger drill one should be selected that will have a diameter slightly larger than the web of the large drill.

After the larger drill is in place in the chuck it is brought down so that the web or point will rest in the hole or depression left by the small drill. A slight pressure is applied and the drill is then lifted to determine whether or not it has left its center. In case it has not it is returned to the metal and the drilling is carried further. Again the drill is lifted and the worker should notice how close to the center it has been, using the circle as a guide. If the drill is proceeding properly it is returned to its place and the hole continued until the drill protrudes at the opposite side. The same procedure is followed out with the large-sized hole.

The smaller holes are now ready to be drilled and the proper size drill is placed in the chuck. If the outside holes are to be drilled with a No. 20 drill the centering can be done with a No. 35 drill. This drill is used in the same manner as the centering drill for the large hole, and after the center has been properly made with it the

No. 20 drill is inserted in the chuck, and, after one or two trials, the drill is carried through the metal.

When a drill is to be used in drilling brass or cast iron, it should not be sharpened in the usual manner. If such a drill is used to drill brass or cast iron it will have a tendency to dig or bite into the work. This is overcome by grinding the lip off the drill as illustrated at Fig. 136. Such a drill will cut evenly and smoothly with no trouble. It will not be necessary to cut very much of the lip away.

The speed of a drill is determined by the metal being drilled and the diameter of the drill. If the diameter of

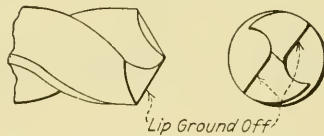

Fig. 136—How a drill is ground for the drilling of brass and cast iron

the drill is very large the speed should be reduced proportionately, but this does not hold true for small drill presses owing to the fact that they will not accommodate a drill over  $\frac{3}{8}$  in. in diameter and this is not considered very large. As a general rule the smaller drills are run at high speed and the larger ones at low speed. An easy method of obtaining the approximate speed of a drill is that of dividing 80, 110 and 180 by the diameter of the drill which will give the number of revolutions per minute for steel, cast iron and brass respectively. In drilling wrought iron or steel, the drill should be flooded with a cutting compound or lubricant. Ordinary machine oil can be used for this purpose or a less expensive substitute can be found in good soapy water. Brass, copper and cast iron should always be drilled dry.

It is advisable many times to employ what is known

as a lead hole when drilling a hole with a large drill. This facilitates cutting, for the large drill and also makes a more accurate job. Such a lead hole is shown in Fig.

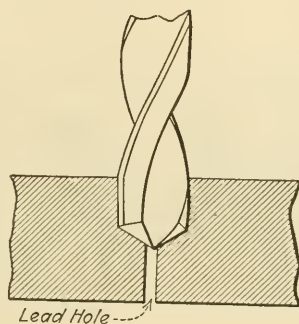

Fig. 137—A lead hole made by a smaller drill will guide a larger drill

137. In case of a hole being drilled on a slightly inclined surface the lead hole should always be used as the web of the large drill is so thick that it is difficult to start

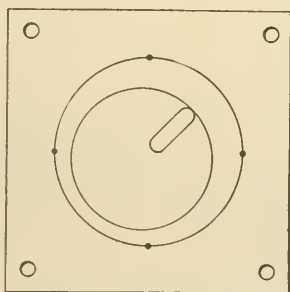

Fig. 138—How a drill is brought back to center after it has slipped off

it cutting accurately on anything but a surface which is at exact right angles to the drill.

Oftentimes in starting a large drill it has a tendency to slip to one side and it is possible to bring it back to the proper position providing it has not drilled too deep. If the drill has just gone to a point where its full diam-

eter is cutting, the resulting hole is called a dimple and beyond this point it is very difficult to bring a drill back to center. The method of drawing a drill is shown in Fig. 138. A small, gouge-pointed chisel is used in dig-

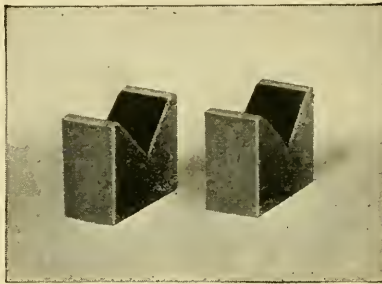

Fig. 139—A pair of V-blocks

ging out a little valley extending from the center which the drill has made to the side opposite from that toward which the drill is slipping.

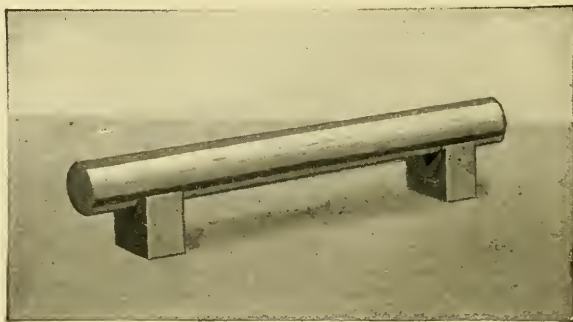

Fig. 140—How a piece of round stock rests in V-blocks

In drilling a transverse hole through a round piece of stock, much difficulty will be met in causing the drill to pass through the exact center. The larger the drill is and the smaller the diameter of the stock being drilled, the more difficult this will become. It is practically impos-



sible to drill such a hole accurately without the use of what are known as V-blocks. A set of these blocks is shown in Fig. 139. These are very accurately cut and

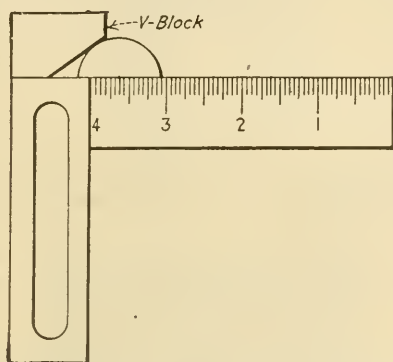

Fig. 141—Methods of finding the center of a rod

sold by the manufacturers of small drills. If it is desired to produce a transverse hole in a piece of round stock, the stock rests in the V-blocks as shown in Fig. 140. Held in this position, the rod or stock is not easily rotated and if

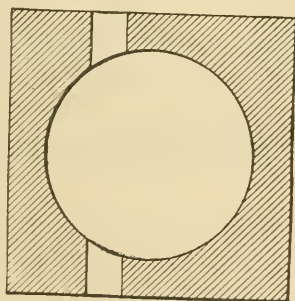

Fig. 142—The text describes the method of drilling a hole in this manner

care is taken in starting the drill, a perfectly accurate result can be obtained. To make sure that the point of the drill is at the center of the stock, the method shown

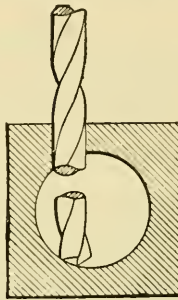

Fig. 143—How a drill would break if the hole shown in Fig. 142 was drilled in the usual manner

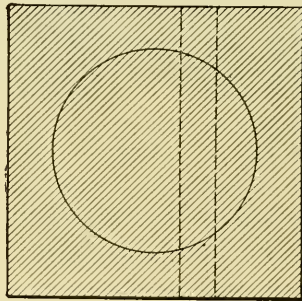

Fig. 144—How the hole is plugged for drilling

in Fig. 141 is used for marking. After the center line has been scratched, the small keyway rule which was previously described is placed upon the shaft and a line drawn its entire length or to a point where the hole is to be put through.

A good lesson in drilling can be learned by assuming that a hole is desired through a piece of metal as shown in Fig. 142. It would be impractical to start drilling this hole in the ordinary manner, as a broken drill would be sure to result, as shown in Fig. 143. The only practical method of overcoming this difficulty is to plug the hole up temporarily and drill through both the plug and the metal, as shown in Fig. 144. For best results, the plug

should be made of the same metal as the stock being drilled.

All holes in soft materials such as fibre, wood and sheet metal can be cut to practically any diameter up to 5 in. by the use of the simple drill shown in Fig. 145. This is

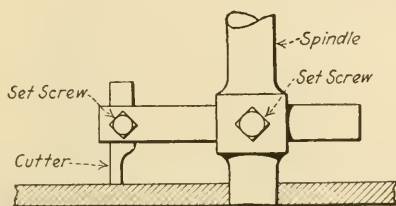

Fig. 145—A fly-cutter and its use

known as a fly-cutter and it will be seen that it consists of a main spindle through the center of which an arm passes. This arm is adjustable and held in any one position by means of a set-screw. At the end of this arm is a small cutter which is made of tool steel. This is also

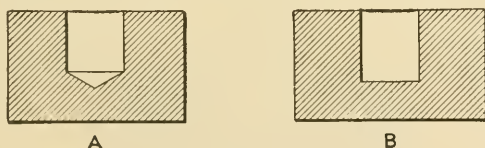
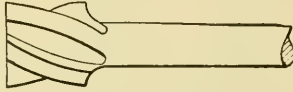

Fig. 146—The bottom of a hole drilled by an ordinary drill and the bottom of a hole finished with a bottoming drill

adjusted vertically by means of a set-screw. To drill a hole with this instrument it is first necessary to provide a center upon which the spindle can revolve. To do this, a hole is drilled for a short distance with a drill slightly larger than the diameter of the spindle. The point of the spindle is then inserted in this hole with a little lubricating oil to prevent undue friction and wear. The device is then driven at a speed of about 500 R.P.M., and

only a slight pressure should be used. In cutting a hole in thin sheet metal with this device, the metal should first be screwed to a block of wood.

An ordinary drill leaves a hole with a bottom similar to that shown in Fig. 146 at A. If it is desired to pro-



**Fig. 147—A bottoming drill**

duce a perfectly flat bottom, as shown in B (Fig. 146), what is known as a bottoming drill is employed. Such a drill is illustrated at Fig. 147. This drill can also be used as a counter-bore, as shown in Fig. 148. It is often necessary to use such a drill for this purpose in order to form a proper seating for a fillister head screw, as shown in Fig. 149.

In case it is desired to form a seating for a flat-headed

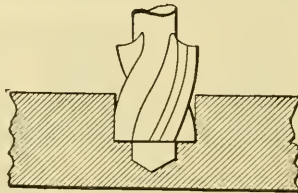

**Fig. 148—The use of a bottoming drill**

screw, a counter-sink must be used. Counter-sinks are made in various angles and several are shown in Fig. 150. A flat-headed machine screw properly seated by means of a counter-sink is shown at Fig. 151. After continued use, the edges of the counter-sink become dull, but it is an easy matter to restore their original cutting efficiency by rubbing a small abrasive stone over their cutting edge. Counter-sinks should be run at a speed in

the neighborhood of 300 R.P.M. when being used and too great a pressure should not be exercised as the strain on the cutting edges will be increased to a point where breakage is liable to take place.

It is possible to produce a square hole by the method

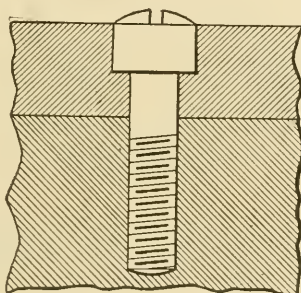

Fig. 149—How a filister head screw sets in a hole finished with a bottoming drill

shown in Fig. 152. The tool used is termed a drift and it is cut in the end of a round piece of stock as shown. It should have slightly tapering sides, starting from the end and tapering back to the shoulder. Such a drift can be made from tool steel properly hardened and tem-



Fig. 150—Three different counter-sinks

pered. To use a drift, it is first necessary to drill a hole in the stock using a drill with a diameter equal to the width of the drift. If a very large hole is being drifted out it is advisable to employ a small drift first, following it by a larger one. It will be understood that the larger a hole is the more metal it will be necessary for the drift to remove.

At this point it will be well to understand the reamer and its use. It is utterly impossible to produce a hole

exactly to size by using a drill. To produce a hole with an exact diameter a reamer is employed. The reamer is used on drill presses and lathes and a special type is generally used for reaming by hand. These are known as hand reamers and one is shown in Fig. 153. In using the reamer, a hole approximately the diameter of the

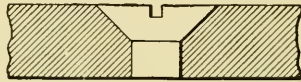

Fig. 151—How a flat head screw sets in a hole finished with a counter-sink

reamer is first drilled. This hole should be from  $1/32$  to  $1/64$  in. smaller than the reamer. For instance, if a hole exactly  $31/32$  of an inch is desired, a drill in the neighborhood of  $15/16$  inch in diameter should be used to drill the hole. If a hand reamer is used it is inserted

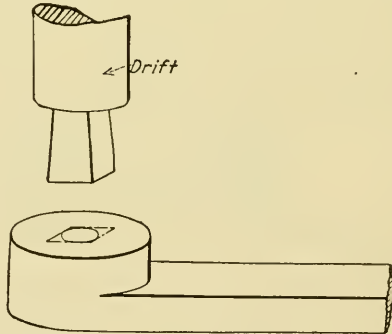

Fig. 152—A drift and its use in making a square hole

in a small wrench such as shown at Fig. 154. The end of the reamer is then inserted in the hole and with a slow, twisting motion the reamer is gradually forced through. If steel stock is being reamed out, it is advisable to use a little lubricating oil on the reamer, as this

will facilitate cutting. After the reamer is removed from the hole, it will be found that a perfectly smooth result is produced exactly to size.



Fig. 153—An ordinary reamer

When a reamer is used in a drill press, the press should be reduced to a minimum speed, otherwise the reamer is apt to chatter and it is also liable to catch in the work.

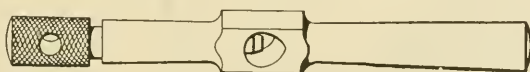

Fig. 154—A small tap and tool wrench that finds many uses

High speed also imposes extra duty upon the cutting edges and breakage becomes very possible.

The reamer just described is the type known as a parallel reamer, owing to the fact that the edges are parallel to one another. What is known as a taper reamer is shown in Fig. 155. A taper reamer is used to produce

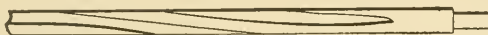

Fig. 155—A small taper reamer for use in a tap wrench

A taper reamer is used to produce a hole with diminishing diameter and the drill used to start the reamer should not have a diameter greater than the smallest diameter of the reamer which will be at its end.



Fig. 156—A large taper reamer

a hole with diminishing diameter and the drill used to start the reamer should not have a diameter greater than the smallest diameter of the reamer which will be at its end.

A spiral-fluted taper reamer is shown at Fig. 156. Such reamers are rarely used in small shops and therefore the amateur mechanic will seldom find occasion to employ such a tool.

A burring reamer is a very convenient little tool to

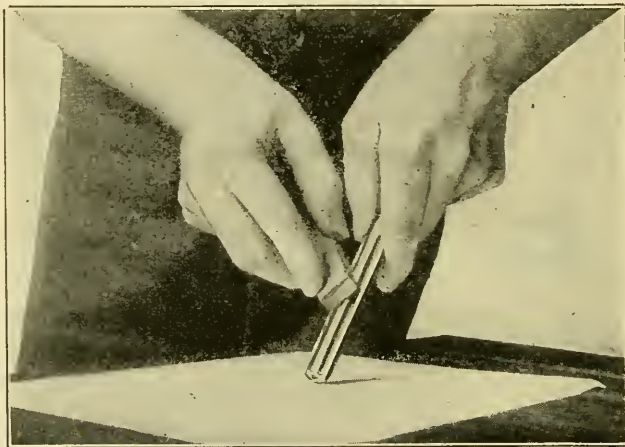

Fig. 157—The use of a hand stone in sharpening a reamer

have on hand. It is used to remove the burrs or rough edges left by a drill. To use it, its end is merely inserted in the hole and the reamer turned several times. This operation will effectively remove the burrs, leaving a nice smooth edge.

The use of reamers in connection with lathe work will be described in the chapter devoted to lathes.



## CHAPTER V

### Introduction to Lathe Work

Operation of the lathe—Simple lathes—Names of lathe parts for simple lathe—Lathe speed—Lathe tools—How to use lathe tools—How to sharpen lathe tools—Lathe dog—Turning simple work—Mounting work in lathe—Using simple lathe attachments—Use of face plate—Mounting work on face plate—Turning brass—How to sharpen tool for brass—Turning steel—Lathe chucks—Drilling on lathe—Slide rest and its use in turning—How to sharpen the various lathe tools—Lathe hand tools—Lathe power tools—General information on the operation, construction and use of simple lathes.

THE lathe is by far the most important and useful tool in the shop and a great amount of experience is necessary to handle it properly. In writing this Chapter on the introduction to lathe work, the author is assuming that his reader knows little or nothing about the lathe and its *modus operandi*.

A lathe can be described as a machine in which pieces of metal, wood and other substances, can be revolved. A sharp-pointed tool of hardened steel is brought against the revolving work and made to cut it. It must, of course, be understood that the cutting tool must of necessity be much harder than the substance being cut.

A very simple bench lathe is shown in Fig. 158. The names of the various parts of this lathe are shown on the drawing. The head stock holds the revolving spindle and this is driven with a belt by means of the pulleys shown. These pulleys are arranged in steps so that various speeds can be obtained. Fig. 159 shows a metal

rod mounted in the lathe ready for turning. Before considering the matter of turning the metal rod to a specified diameter or shape, the method followed in mounting the rod in the lathe will be treated.

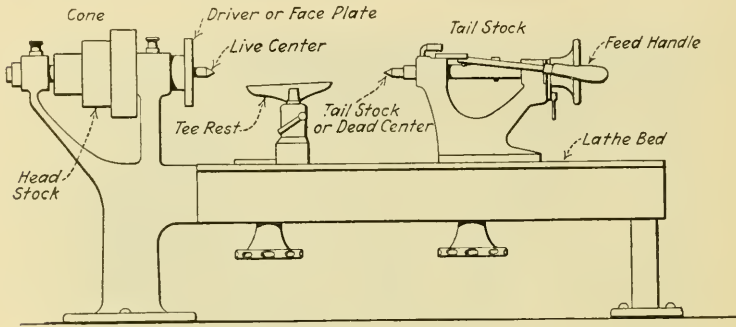

Fig. 158—A bench lathe and the names of its various parts

It will be seen that the two sharp-pointed centers of the lathe protrude into the ends of the rod. The centers of the lathe are ground at an angle of 60 degrees and

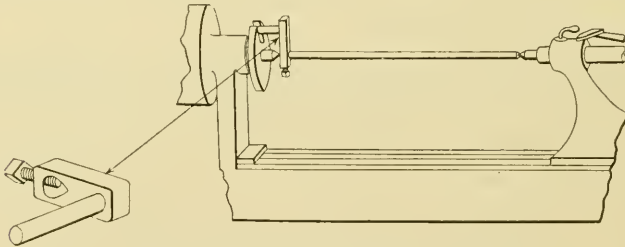

Fig. 159—A lathe dog and its use

therefore the holes in the ends of the rod made to accommodate the centers must also taper at 60 degrees as shown in Fig. 160. It must be understood that before the holes are produced the exact center of the rod must be found. There are several methods of finding this exact center. Probably the easiest method is when what

is known as a centering drill is used to drill the hole. Such a drill is shown in Fig. 163. If an ordinary drill was used, the centers would come into place as shown in Fig. 164. As a result the sharp edges of the work would gradually wear back as the work was revolved and would

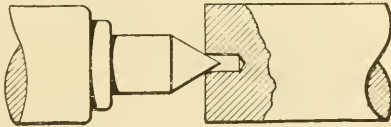

Fig. 160—An improperly ground center

become inaccurate. The points of the centers of the lathe should never come in contact with the work they are holding and the centers should always be kept perfectly sharp and ground true.

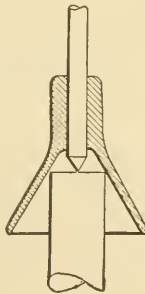

Fig. 161—A self-centering punch

The work is driven on the lathe by what is known as a lathe dog. A simple lathe dog is shown at Fig. 165. This type of lathe dog is suitable for small bench lathes, but a different type is necessary for use on larger lathes as will be explained later. The protruding arm of the lathe dog rests in a slot cut in the face plate. A small set-screw on the lathe dog grips the work firmly.

It will be assumed that part of the metal rod in the

lathe is to be turned down as shown in Fig. 166. To guide the workman in producing the proper profile on

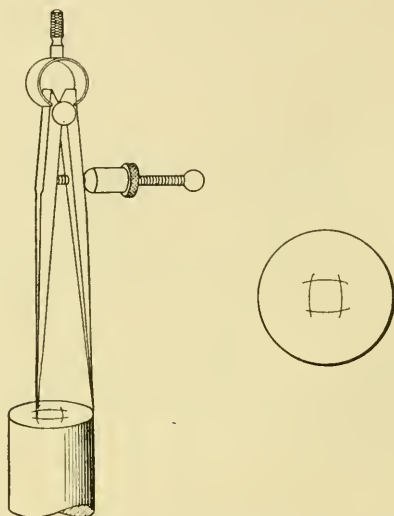

Fig. 162—How a center can be approximately found with a pair of dividers

the work, it will be necessary to cut what is known as a template. The template for use in connection with the job under consideration is shown in Fig. 167. As the



Fig. 163—A lathe centering drill and counter-sink

work nears completion, the template should be brought in contact with the rod frequently so as to determine

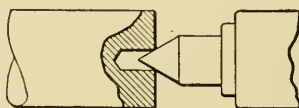

Fig. 164—How the center would rest in a hole produced with an ordinary drill

whether or not the rod is approaching the proper shape. The turning should be continued until the template fits exactly over the rod.

The actual use of the turning tools must now be con-

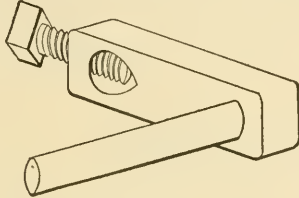

Fig. 165—A simple lathe dog for use on a bench lathe

sidered. A set of hand turning tools is shown in Fig. 168. Many of these tools can be ground to shape from old square files and it will be seen that tools with many dif-

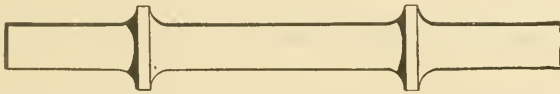

Fig. 166—A piece which can be turned by the use of a template

ferent-shaped cutting points are necessary to carry on work. This is especially true if odd shapes are being turned. The cutting tool is placed in the position de-

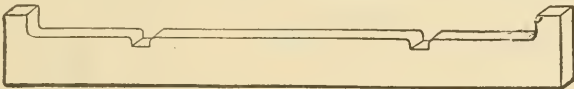
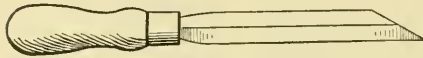

Fig. 167—The template used in producing the piece shown in Fig. 166

icted in Fig. 169 for cutting. The tee rest is brought as close to the work as possible (usually about  $\frac{1}{4}$  in.) and the remainder of the tool is held firmly in the hands of the worker. The center rest should be so adjusted that the cutting edge of the tool will come in contact with the work at its center. If the tool is too far above or below

the center of the work, it will not cut efficiently. The beginner should take care not to use too much pressure and it will be found after some cutting is done that a remarkable control can be obtained over the tool. While this control of the tool can be exercised freely in producing various shapes it will be found that it is extremely diffi-



Graver



Hook or Heel Tool

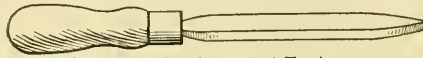

Flat Ended Tool

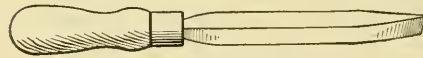

Square Ended Tool

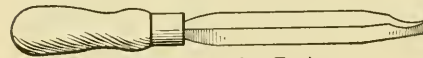

Beak Working Tool

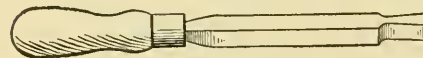

Parting Tool

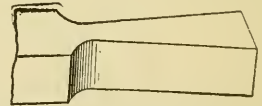

Fig. 168—A set of hand turning tools for use with metal

cult to produce a rod of exact diameter for any great length. A mechanic who is able to do this must have many years of experience in hand turning and such a job would be quite hopeless for the average amateur mechanic.

The parting or cutting-off tool must be manipulated in

a certain way to produce good results. Considerable pressure must be used with this tool and its cutting edge should be fed into the stock with a slightly rocking motion. This rocking motion is produced with the hand on the end of the tool.

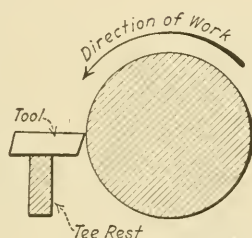

Fig. 169—The direction of the work in a lathe in relation to the point of the cutting tool

Another method of driving work on the lathe is shown in Fig. 170. Two small bolts pass through the slots of the face plate and clamp the stock in position. In doing this it will be necessary that the stock be mounted as close

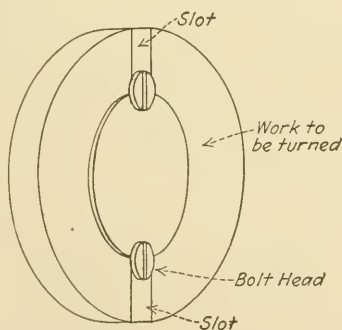

Fig. 170—How a circular piece is held to a small lathe face plate to the center as possible, otherwise the turning will be eccentric.

Tools for use on brass must be ground differently from

those used in turning steel. Properly ground tools for use on these metals are shown in Fig. 171. The tool used for turning steel has what is called a positive rake; i.e., its edge inclines *from* the work. If such a tool with a positive rake was used in cutting brass, the nose or point would have a tendency to dig in, and if a hand tool was used it would probably either break the point or snatch the tool from the mechanic's hand. At any rate the work would be ruined. A tool for cutting brass must have what is known as a negative rake; the point of the tool inclines *toward* the work. A tool so ground will cut

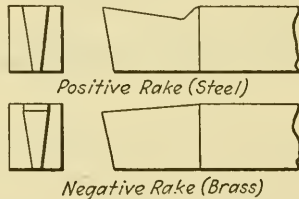

Fig. 171—Illustrating the meaning of positive and negative rake

smoothly with no tendency to dig into the surface of the metal. A tool with a negative rake must also be used when turning iron as this metal possesses the same peculiar properties as brass. The tool with the negative rake scrapes the metal away in small pieces while the action of a tool with a positive rake is entirely different—it cuts the metal away in the form of long curls.

When cutting steel stock with hand tools, a lubricant of some sort should be used. The lubricant can be contained in a small can so arranged over the work that the lubricant will drop on the edge of the cutting tool or on the work. Oil is rather expensive for this purpose and a good substitute can be found in thick, soapy water. Brass will not need to be lubricated.



The usefulness of the small lathe described in this Chapter can be greatly extended by the addition of a chuck such as that illustrated in Fig. 172 at B. The chuck is screwed on the spindle of the lathe in place of

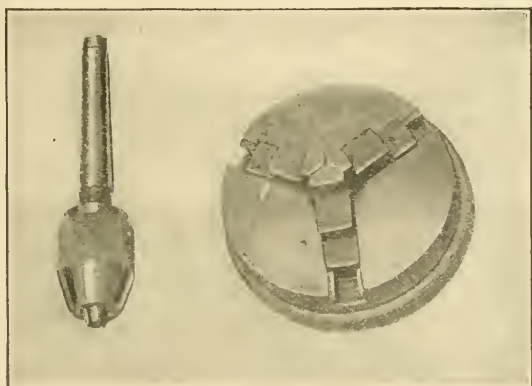

Fig. 172—A drill and three-jawed chuck for use on a bench lathe. The drill chuck has a Morse taper

the face plate. The chuck shown is known as a “scroll chuck.” The jaws are caused to move by revolving the knurled edge seen at the back. Holes are also drilled in

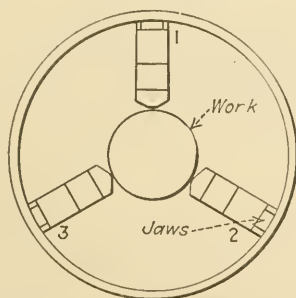

Fig. 173—How work is held in a three-jawed chuck

this edge so that a hook or handle can be inserted to tighten the jaws sufficiently. The work is held in the

chuck as shown in Fig. 173. With the use of this chuck it is not necessary to use two centers in turning a rod as the chuck takes the place of the revolving center. Not only does it take the place of the revolving center but it also replaces the lathe dog. Therefore when using the chuck it is not necessary to drill two centers on the stock.

It will be necessary to use different speeds for different metals. Brass stock should be revolved at high speed and steel and iron at comparatively lower speeds.

Oftentimes a small file can be used advantageously in finishing work being turned. The file is merely held on the surface of the work and carried forward with a light stroke. Emery cloth will also be found useful in producing a polish or taking off a very little metal. The cloth should be cut in strips and wound half around the stock and pressed tightly with the fingers. If a high polish is desired, a very fine cloth should be used and a light pressure applied.

The utility of the lathe is still further increased by the addition of a drill chuck as shown at A, Fig. 172. The drill chuck is provided with a tapered shank. This tapered shank fits in place in the tail stock. Before it can be put in place it is necessary to remove the tail stock center, which is also provided with a taper shank. With the use of the drill chuck it is possible to use the lathe as a drill press and for other miscellaneous jobs. If it is desired to drill a hole in a piece of work that is held in the large chuck, the drill is merely inserted in the drill chuck, the tail stock moved along to the proper position and clamped and the drill is then fed into the work.

It will be found that the hole in the spindle of the lathe which held the live center is tapered to accommodate the

shank of the drill chuck. To extend the use of the lathe as a drill press the drill chuck is placed in the spindle. Then what is known as a drill pad is placed in the tail stock. Such a drill pad is illustrated at Fig. 174. This is also provided with a tapered shank which feeds into the hole in the tail stock. The work to be drilled is held

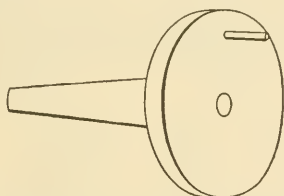

Fig. 174—A drill pad for use in the tail stock of a bench lathe against the surface of the drill pad. The little stud or pin in the drill pad is used to prevent the work from turning or slipping from the grasp of the mechanic.

As before stated, it is practically impossible for an

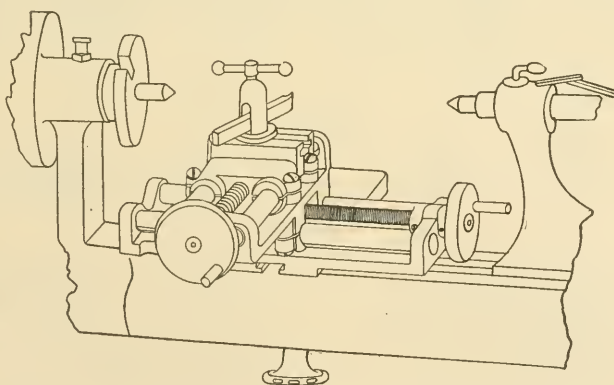

Fig. 175—A slide rest for a bench lathe of popular make

amateur to produce accurate work with hand turning tools. To do this a slide rest must be added to the equipment of the lathe. A small slide rest manufactured to use on the lathe mentioned in this chapter is illustrated

at Fig. 175. The cutting tool is held rigidly in the slide rest and fed to the work with the two handles on the device. One handle moves the tool parallel with the surfaces of the work and the other moves it transversely or into the work. The tools used with the slide rest are different from those of the hand variety. They consist merely of a piece of tool steel with a properly ground cutting edge.

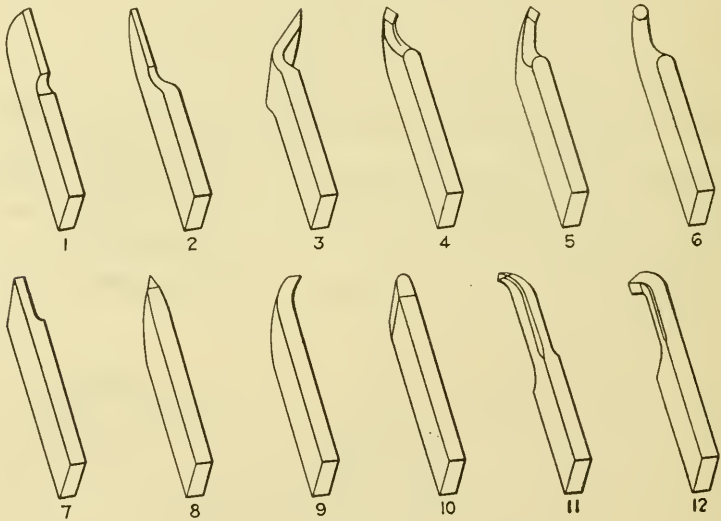

Fig. 176

1—Left-hand side tool  
 2—Right-hand side tool  
 3—Right-hand bent tool  
 7—Cutting-off tool  
 8—Threading tool  
 9—Bend threading tool

4—Right-hand diamond point  
 5—Left-hand diamond point  
 6—Round-nose tool  
 10—Roughing tool  
 11—Boring tool  
 12—Inside threading tool

A complete set of lathe tools is shown at Fig. 176. Each tool is intended for special work. The uses of the various lathe tools are illustrated in Fig. 177. The mechanic will readily understand these tools and their

uses with the possible exception of the tool used in cutting screw threads. The use of this particular tool will be described in a later chapter.

To work properly, lathe tools must be kept in a sharpened condition. When their cutting edges become badly

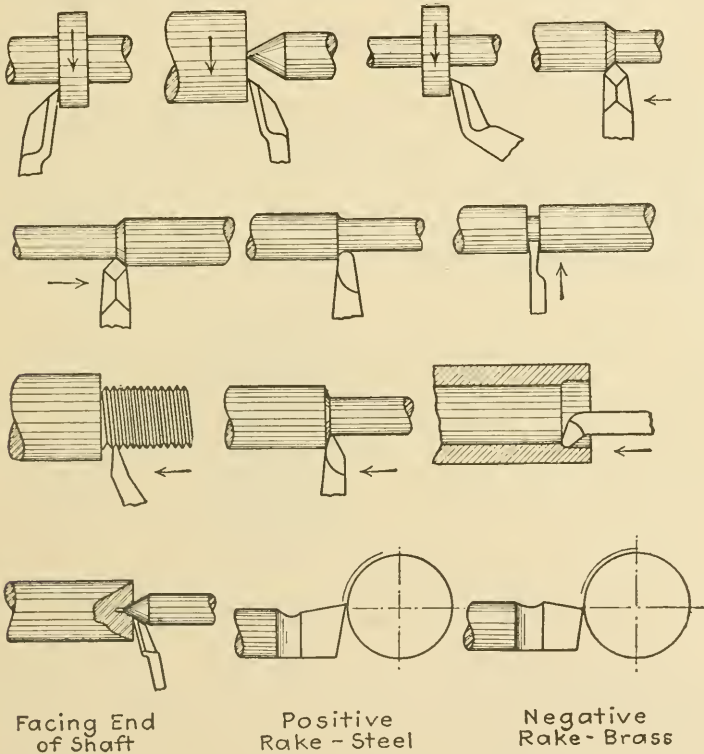

Fig. 177—Illustrating the use of the different lathe tools shown in Fig. 176

worn they are generally brought back to shape on a grinding wheel. In grinding a tool, care should be taken to see that its temper is not effected by over-heating. To prevent this the tool should be dipped repeatedly in a convenient receptacle of cold water. If a drill is allowed

to remain on a grinding stone until its point becomes blue, it is rendered useless for further work until it is again put through a hardening process. This is called "burning" the tool.

Two badly ground tools are shown at A and B, Fig. 178. The tool shown at B will not cut effectively owing to the fact that its actual cutting edge is prevented from coming in contact with the work. In fact, if the tool is ground too round, the cutting edge will not come in contact with the work at all and the metal will be rubbed away. This will set up undue friction and if the stock is revolving at a high rate of speed the drill is very apt to lose its hardness by over-heating.

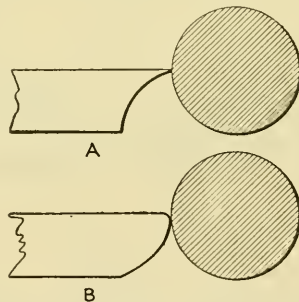

Fig. 178—Improperly ground lathe tools

The opposite extreme is shown at A. A tool ground in this manner will be very apt to break. This is because the cutting point does not have the proper support from beneath. The steel from which tools are made is hardened to such an extreme degree that it is very brittle and breaks with very little strain.

## CHAPTER VI

### Advanced Lathe Work

Larger lathes—Description of lathe parts—Lathe saddle—Tailstock—Use of tailstock—Headstock—Slide rest—Use of slide rest—Cross slide—Center rest—Use of center rest—Live center—Dead center—How to take care of centers—Pulleys—Lathe speed—Back gears—Use of back gears for various speeds—Live center—Dead center—Grinding centers—Mounting work between centers—Lathe chuck—Lubrication and care of lathe—Setting up and driving the lathe—Power required—Setting up line shaft and countershaft—Lathe swing—Shaft hangers—Speed of line shaft—Mounting of power motor—Bench lathes—Simple turning—Boring cylinder—Machining crankcase—Making bearings—Machining odd shaped pieces of work—Use of face plate—Use of blocks and clamping bolts—Use of angle plate—Mounting casting of angle plate for machining—Turning sheet metal—Turning eccentrics—Use of mandrels—Eccentric mandrels—Turning flywheels—Boring bars—Boring tools—Use of boring bars—Turning crankshafts—Turning four-throw crankshaft—Making built-up crankshaft—Thrust bolts—Screw cutting—Placing gears for screw cutting—Grinding and mounting tools for screw cutting—Thread gauges.

BEFORE starting the subject of more advanced lathe work it will be well to consider the standard lathe and its fitments. The small lathe shown in Fig. 179 is very well adapted for use in the amateur's shop. Such a lathe can be purchased for about \$150.00 and a great amount of work can be accomplished with it. In fact, with a few attachments, practically any ordinary job of machining can be done.

The general principle of this lathe, of course, does not

differ from that of the more simple tool described in the previous Chapter; it merely has a greater number of attachments. The saddle which holds the compound slide rest is moved along the lathe bed by means of the apron hand wheel. This is accomplished through a rack and pinion system and the rack will be noticed at the side of the lathe body near the top. The compound rest has two handles, one which feeds the tool parallel with the work and one which feeds it crosswise. The tool post will be

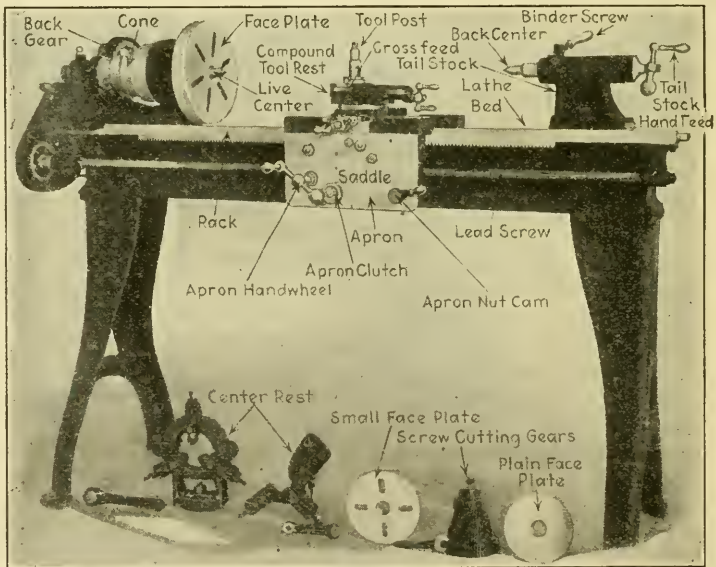

**Fig. 179—A screw-cutting lathe and the names of its various parts**

noticed on the top of the compound rest and the tool is held in place by the screw at the top of the post. This particular portion of the lathe should be well taken care of as inaccuracy in the work being turned will result if its parts are not carefully adjusted and maintained in good condition.



The tail stock of the lathe is provided with a ball crank at the end, by means of which the spindle is moved forward and backward. This spindle can be locked in any one position by means of the binder screw at the top. The back center is held in the hollow spindle of the tail stock and this can be taken out by moving the spindle back as far as it will go, by means of the feed handle or ball crank. The center can be replaced by either a drill chuck or a drill pad. Large drills with tapered shanks can also be placed in the tail stock spindle providing the taper corresponds with that of the spindle. On larger lathes, means are provided to set the tail stock off center to accomplish taper turning. This will be described in detail in a later part of this Chapter. The complete tail stock can be moved along the lathe bed and locked in any position by means of a binder screw and nut on the opposite side to that shown in the photograph.

The head stock spindle also has a standard taper and is made to accommodate a center. External threads are cut on the nose of the spindle and in this way the face plate, driver plate, or chuck is put in place. To remove these attachments the back gears should be thrown in mesh and the chuck or plate should be turned in the same direction in which the lathe travels.

The particular lathe shown in Fig. 179 is provided with a cone pulley which has four steps and these four variations in speed can be obtained without resorting to the back gears. The back gears of the lathe are only employed when heavy turning is being done. It must be understood that adjusting the motor speed for such a purpose would be very impractical, and, in fact, it would be impossible for many jobs. A reduction in the motor speed would mean a reduction in the power developed

by the motor and therefore the motor would not be able to turn the lathe around if a heavy cut was being taken. By the use of the back gears, the speed reduction is obtained without any necessary reduction in the speed of the motor. Therefore, the duty imposed upon the motor is the same and its speed will be maintained at its normal working capacity.

The lead screw shown at the side of the lathe runs its entire length and at the head stock end a small gear is attached. This gear is one of a train of gears that connects the lead screw to the spindle of the head stock. The speed of the lead screw can be regulated by a proper selection of gears. A set of screw-cutting gears is shown with the attachments which rest beneath the lathe in Fig. 179.

On the back of the lathe apron there is a split nut and this split nut can be tightened by the apron nut cam. When this is done, the lead screw drives the saddle of the lathe along the lathe bed. When a properly ground tool is inserted in the tool post, screw cutting can be accomplished in this manner. It is not advisable to go more deeply into the subject of screw cutting at this juncture. Therefore, this particular phase of lathe work will be considered in the latter part of this Chapter.

The necessary attachments for a larger lathe are shown underneath the lathe in Fig. 179. The center rest is a very important attachment and it is used in turning long rods between centers. If a long piece of stock with a small diameter is being turned between centers it will spring when the tool is brought in contact with it. To overcome this, the center rest is used and the rod passes through this attachment. The jaws, which are adjustable, are brought in contact with the rod and held in this

position by the screws. A close-up view of a simple, three-jawed center rest is shown in Fig. 180. A binder screw is at the side of the center rest so that it can be locked in position on the lathe bed. The same wrench is used on the nut of this bolt as is used on the nut of the binder screw which locks the tail stock in position. The jaws are prevented from slipping back by means of the

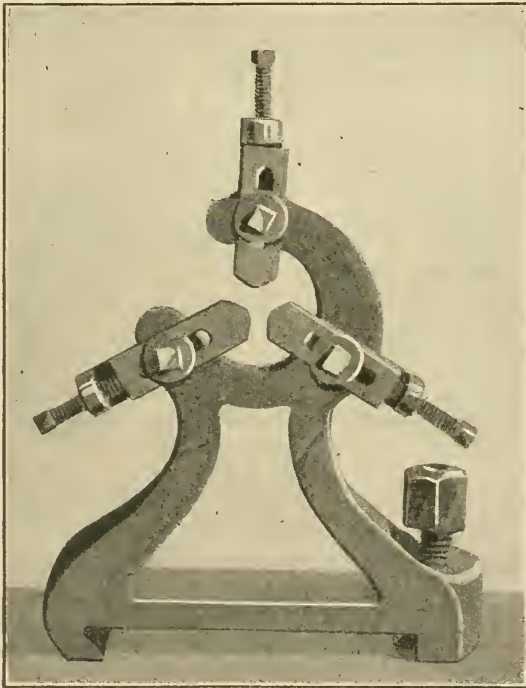

Fig. 180—A three-jawed center rest

screws shown. These screws can also be used in adjusting the jaws. If the screws are not used in this way, they should be turned until their ends come against the end of the jaws after the work is mounted. The jaws should not be adjusted too tightly as this will wear a

groove in the work. A two-jaw center rest is shown beside the three-jaw center rest in Fig. 179.

A good lathe can be kept good only by constant care. Once a lathe is rendered inaccurate by abuse, it is a very difficult matter to bring it back to its original condition. Therefore the amateur mechanic should take a great pride in keeping his machine clean and in repair. The bearings should be watched carefully and well oiled at regular intervals. Only the best grade of machine oil should be used. The utmost caution should be taken to prevent chips of metal from getting into the bearings. The bearings of good lathes are made of bronze and once a chip of steel gets into them great havoc is wrought. In the event chips find their way into a bearing, it is best to take the shaft out of the bearings and wash them well with kerosene or gasolene. All the moving parts of the lathe should be kept well lubricated. A thin film of oil should be always kept on the lathe bed. This permits the saddle to ride smoothly and easily over the machined surface and it also prevents the bed of the lathe from being attacked by moisture.

When using the lathe, the amateur mechanic may acquire the habit of placing his tools on the lathe bed, using it as a table. This is bad practice as it mars the surface of the lathe bed and will therefore impair its accuracy if continued. It is a perfectly natural thing to lay a file down across the lathe bed temporarily after it has been used, but, on the other hand, it would be just as easy to place the file on a table at the back of the lathe, which could be made to hold the tools being used. If the lathe is not to be used for any great length of time, all of its machined surfaces should be well smeared with vaseline. The lead screw should be kept smeared with grease at all

times. It will be found that the vaseline can easily be removed with a piece of waste soaked in gasolene when it is again desired to use the lathe.

The reader will now have the general operating features of a lathe in mind and it will be advisable, before going further, to say a few words about the setting up of a lathe and the method of driving it. The power necessary to drive a lathe should be determined first, and this will depend entirely upon the size of the lathe. Lathes are classified in sizes according to their swing and maxi-

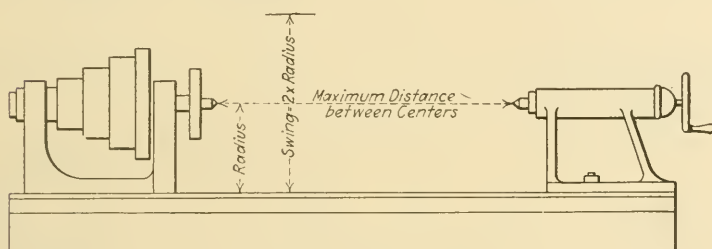

Fig. 181—Showing what is meant by “swing” and “maximum distance between centers”

imum distance between centers. What is meant by the swing of the lathe will become apparent by referring to Fig. 181. Here it will be seen that the swing of a lathe is twice the distance of the center from the bed of the lathe. Thus, a lathe with an 11-in. swing is capable of turning a piece of work that will swing in a circle nearly 11 in. in diameter. The maximum distance between centers is reached when the tail stock is slid to the end of the lathe bed. The horsepower necessary to drive lathes with a swing of from 11 in. to 18 in. is given in the following table:

## POWER FOR LATHE

|               |   |                |            |
|---------------|---|----------------|------------|
| 11 inch swing | — | $\frac{1}{2}$  | horsepower |
| 12 " "        | — | $\frac{1}{2}$  | "          |
| 13 " "        | — | $\frac{3}{4}$  | "          |
| 14 " "        | — | 1              | "          |
| 15 " "        | — | 1              | "          |
| 16 " "        | — | 2              | "          |
| 18 " "        | — | $2\frac{1}{2}$ | "          |

The general outline of a lathe and its driving equipment is shown at Fig. 182A. It will be seen that the motor is mounted on a shelf or a bracket on the wall. A belt

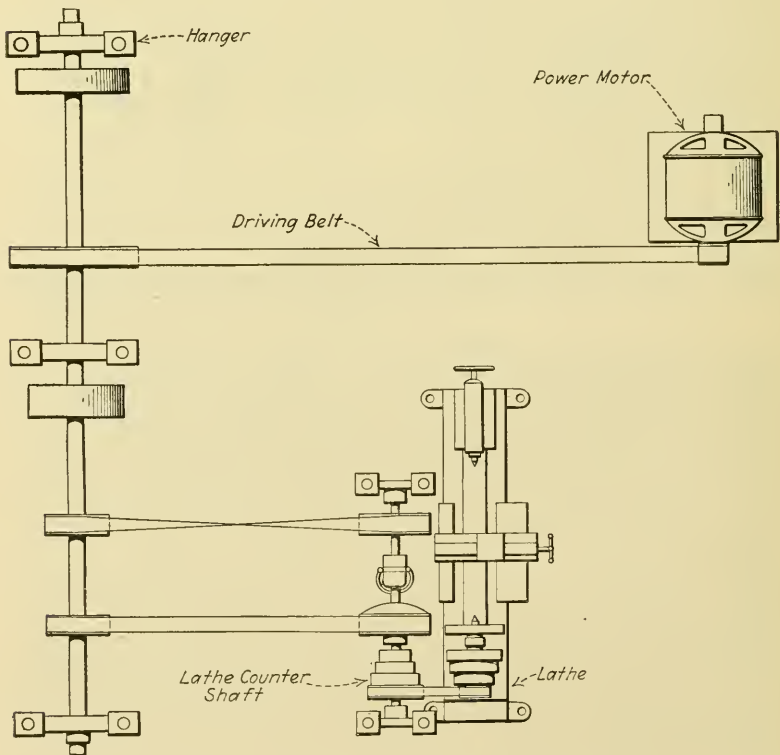

Fig. 182A—The layout of a small lathe shop

runs from this to the line shaft and from the line shaft two belts run to the lathe counter-shaft. One of the belts which runs to the lathe counter-shaft is twisted and by means of a clutch the rotation of the lathe can be reversed. It is often necessary to reverse the lathe during screw cutting. Ordinarily the twisted belt runs over an

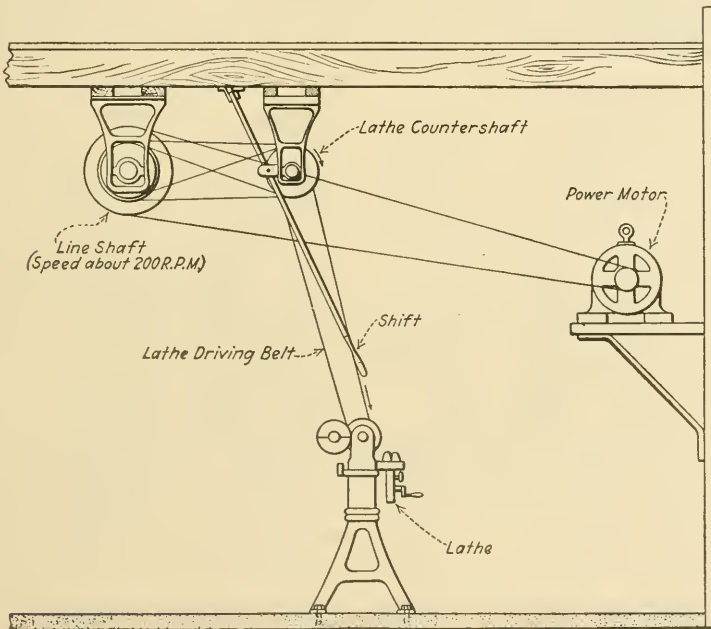

Fig 182B—The position of the lathe in relation to the countershaft

idle pulley but it is caused to take the load of the lathe by a wooden lever within reach of the worker. This lever actuates a clutch and when thrown to one side it engages the pulley upon which the twisted belt runs or the pulley upon which the straight belt runs. When in a neutral position, the clutch does not engage either pulley and the lathe receives no power.

The line shaft in the small shop is not only used to drive the lathe but other shop equipment such as drill press grinder, etc. The line shaft is held to the ceiling by what are known as shaft hangers. The number of hangers used will depend upon the length of the shaft, but they should be spaced not more than 6 ft. apart. The method of securing the hangers to the ceiling joists is shown in Fig. 183. The 2 x 6's are secured to the

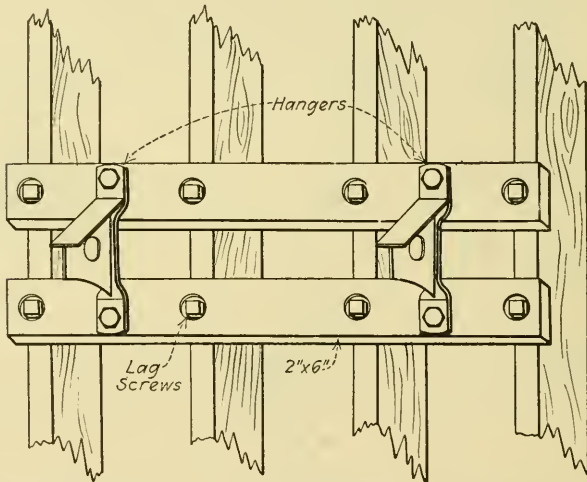

Fig. 183—Method of holding the shaft hangers to the ceiling

ceiling with lag screws. They should be arranged at right angles to the ceiling joists. This can be assured by the use of a square. The hangers are fastened to the 2 x 6's by the use of heavy bolts. There are several different types of hangers on the market and many of these are made of pressed steel. Others are cast. All hangers, however, are merely used to hold the bearings of the line shaft. The line shaft is of cold rolled steel approximately  $1\frac{1}{2}$  in. in diameter. It should not vary over  $\frac{1}{8}$  in.



above or below this figure. Either wooden or steel pulleys can be used on the line shaft. Split wooden pulleys are to be especially recommended. These pulleys come in halves and are bolted over the line shaft.

The speed of the line shaft is very important and for a small lathe it should rotate in the neighborhood of 200 R.P.M. Electric motors of from  $\frac{1}{2}$  to  $2\frac{1}{2}$  horsepower generally have a speed between 1000 and 1500 R.P.M. For this reason it will be necessary to place a small pulley on the motor and a large pulley on the line shaft to obtain the proper speed reduction. Knowing the speed of the motor and the speed desired it is an easy matter to figure out the relative sizes of the pulleys to be used. The motor should be mounted 10 to 12 ft. from the line shaft. Motors over  $\frac{1}{2}$  horsepower generally require a starting box and this should be located directly under the motor on the wall.

When the line shaft is in position the countershaft is then fastened to the ceiling. The countershaft is always furnished with the lathe and the price of a lathe includes this item. The countershaft is secured to the ceiling in the same manner as the line shaft. The greatest care should be taken to see that the countershaft is mounted exactly parallel with the line shaft, otherwise the belts will be continually running off. The lathe countershaft should be mounted about 6 ft. from the line shaft. If necessary it can be mounted farther away, but, under no circumstances should it be placed any closer.

With the line and countershaft in place, the lathe is ready to be secured to the floor beneath the countershaft. As shown in Fig. 182B, the lathe should properly be mounted from 6 in. to 1 ft. from the countershaft so that the driving belt will be at a slight angle. The lathe is

mounted exactly parallel with the countershaft and it is held to the floor with stay-bolts. In securing the lathe to the floor, a level should be used freely. The level should be placed across the lathe bed first at one end and then at the other, and if it is not sitting true, shims should be used to bring it to the proper position. Pieces of shingle make suitable shims. The level should also be placed parallel with the lathe bed to see that the lathe is not higher at one end than at the other.

If the workshop is on the ground floor it is often possible to make a concrete bed for the lathe to sit on. This gives a very rigid mounting and causes a minimum of vibration when the lathe is running at high speed. In the case of the lathe being mounted on concrete, expansion bolts are used to hold it down.

Before mounting a lathe, the location should be carefully figured out so that there will be ample space for the line shaft and countershaft. The light should also enter into consideration and if possible the lathe should be so arranged that the light will come over the mechanic's right shoulder. All lathes have a hollow spindle for turning long rods and the lathe should not be mounted too close to the wall, otherwise it would be impossible to take advantage of this valuable feature.

With the line shaft, countershaft and lathe in position, the belts can be put in place. Leather belting should be used throughout. In placing the belts, the smooth side should run over the pulley. The rough side of a belt should never be used owing to the fact that poor traction results. This is caused by air pockets forming between the belt and the pulley. When a perfectly smooth belt is used most of the air pockets are squeezed out from between the pulley and belt and good traction is obtained.

Not every amateur is able to afford a costly lathe and many have to be satisfied with a small bench lathe. Such a lathe is shown in Fig. 184. It derives its name from the fact that it is usually placed upon the work bench. The little lathe shown is a very good type and all the operations done on a larger lathe can be accomplished with it. Such a lathe is mounted on the bench with bolts and its countershaft can be placed above it on the wall.

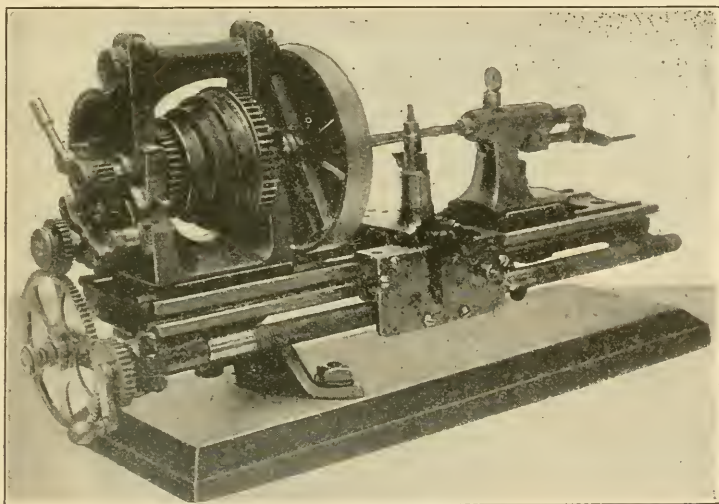

Fig. 184—A small screw-cutting bench lathe

Having set up the lathe it will be well to try a sample piece of turning. This will do more than anything else to acquaint the mechanic with his lathe—it is actual experience which makes good mechanics. It will be assumed that a small roller is to be turned according to the shape and dimensions given in Fig. 185. It will be seen that the diameter of the finished roller is one inch at the widest point. To make the lesson more instructive it will be assumed that a piece of  $1\frac{1}{2}$ -in. stock is the only

material available from which to turn the roller. The first thing necessary will be the facing of both ends of the stock. To do this it is placed in the chuck and the right-hand side or facing tool is mounted in the tool post. For turning on larger lathes it is advisable to mount the tool so that its cutting edge will be about 5 degrees above the center of the work. With the facing tool in the proper position, the end of the stock in the chuck is faced off square. When this is done, the piece is taken out of the chuck, turned around, and the opposite end of it faced off. The drill chuck is then placed in the tail stock spindle and the centering drill put into it. The tail stock is

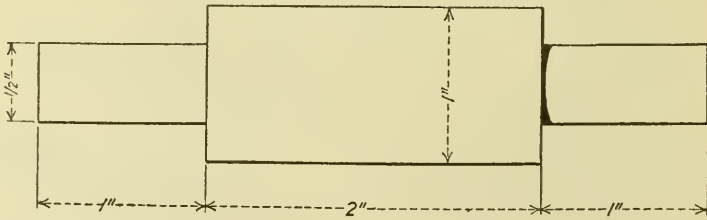

Fig. 185—A piece to be turned as an elementary lesson in lathe turning

then moved to a position where the point of the centering drill will be about  $\frac{1}{2}$  in. from the end of the stock. The binder screw of the tail stock is then tightened and the centering drill is fed into the work to the proper distance. The stock should then be taken out of the chuck and turned around so that the centering drill can be used on the opposite end. To do this the tail stock must be removed and brought back to position when the stock is remounted in the chuck. When the chuck is used to find the center it will not be necessary to employ a centering punch. All lathe chucks are self-centering; when

a piece of round stock is mounted in them it will automatically come to center as all three jaws of the chuck move at the same speed toward the center and they are all mounted in the same position in relation to the center of the chuck. An ordinary lathe chuck is shown at Fig. 186. This is a 3-jaw chuck and a piece of stock will be noticed mounted in place ready for turning. The jaws

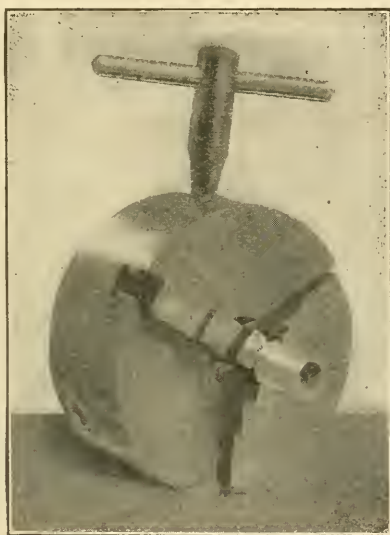

Fig. 186—Work in a three-jawed lathe chuck

of the chuck are moved by means of the key and when placing work in the chuck for turning it should be tightened sufficiently to prevent it from revolving. If a piece of tubing is mounted in the lathe the jaws of the chuck should be moved outward until the shoulders of the jaws come into contact with the *inside* of the tube. If the tubing is thin, the jaws should not be tightened too much, as this will spring it out of shape. If an extra large piece

of tubing or stock is to be turned, outside jaws for the chuck should be used. To use these it will be necessary to remove the regular jaws of the chuck. This can be done by turning the key until the jaws are disengaged. They are then lifted out and the outside jaws put in their place. It will be necessary to put each jaw in the proper place and upon examining the jaws it will be found that they are marked 1, 2 and 3. It will also be found that the slots in the chuck which receive the jaws are numbered 1, 2 and 3 and the corresponding jaw should be placed in the corresponding slot. A set of outside jaws is shown at Fig. 187.

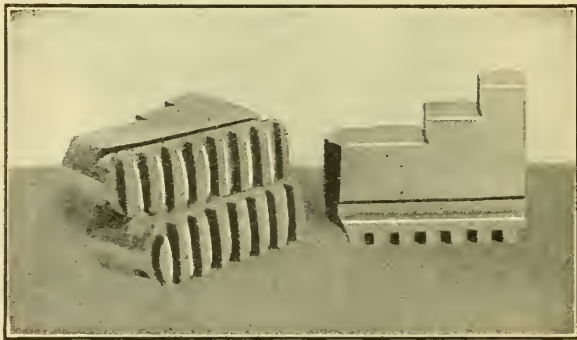

Fig. 187—The jaws of a three-jawed lathe chuck

Returning to the roller which was being turned. With the centering completed, the back gears of the lathe are thrown in and the key inserted in the chuck. The chuck is then given a sharp twist in the same direction in which the lathe revolves and in this way the chuck is removed. When the chuck approaches the end of the screw threads on the lathe spindle, it should be handled carefully, otherwise the threads will be damaged. The chuck is then laid away and replaced on the lathe with the face plate.

When this is done both the centers are put in place. The lathe dog (similar to that shown at Fig. 188) is put over the stock and the set screw tightened. The projecting arm of the lathe dog is placed in one of the slots of the face plate with the center of the lathe in the center hole of the stock. The tail stock of the lathe is then advanced until the center engages the other center hole of the stock. The binder screw is then tightened and when the back gears are thrown out the stock is in position for turning. In locking the tail stock in position the mechanic should see that the centers do not hold the work too tightly, otherwise undue friction will be set up and the center will be worn away. It will be found that there is a center for the tail stock and a center for the head



Fig. 188—A lathe dog of standard type

stock of the lathe. Each center should be used in its proper place. The centers do not differ in shape or taper but one is hardened and the other is soft. It will be seen that the head stock center revolves with the work, but the tail stock center is stationary and therefore the work revolves upon it. For this reason the tail stock center is made of hardened steel. Before setting the lathe in motion, a few drops of oil should be placed on the tail stock center.

The rod is then turned to approximately 1 in. in diameter with a diamond-point tool. Owing to the fact that considerable metal is to be removed it will be necessary to

take several cuts with this tool. The mechanic should take care not to make the cuts too heavy, as the tool is very apt to break. It will be seen that the roller is to be turned accurately to 1 in. In this case, the calipers should be set to  $63/64$ ths of an inch. When the rod has reached this diameter a very light cut should be taken and the micrometer is then applied to the work. If this cut has not been sufficient but is a few thousandths of an inch over size, it can be finished to size by the use of emery cloth of fine grit. This is wound around the work one-half a time and held tightly with the fingers, at the same time running it back and forth. The micrometer can be applied again and this procedure is repeated until the final exact measurement of 1 in. is obtained. The diamond-pointed tool is then taken from the tool post and replaced with a parting tool. One inch from the tail-stock end the parting tool is run into the work. This measurement can be obtained by stopping the lathe, placing the scale at the end of the stock and bringing the parting tool to the one-inch mark on the scale. The parting tool is run into the stock until a diameter  $1/32$  in. larger than the finished size is reached. In this case, the diameter arrived at by the parting tool should be  $17/32$  in. The calipers should be used in determining the distance the parting tool cuts into the work. Having accomplished this, the lathe is again stopped and the scale is put at the end of the groove cut by the parting tool. The tool is then run two inches down the stock and another cut the same as the previous one is made. The parting tool is then taken out of the tool post and replaced with the diamond-pointed tool. The superfluous metal is then cut away from the ends of the rod. The last  $1/32$ nd in. or so of metal is then approximately



taken off with a single cut and the micrometer applied. In making this last cut the mechanic should be sure to leave the stock a little large rather than small so that the final diameter can be produced with the aid of emery cloth. After a mechanic becomes more familiar with the

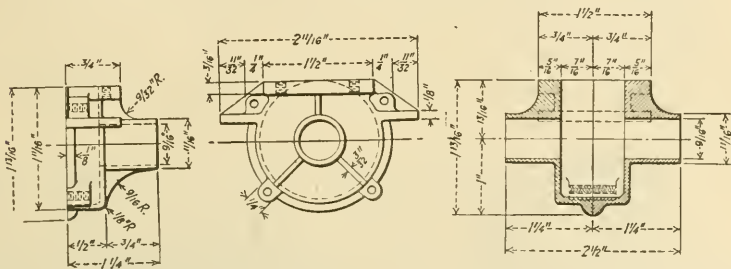

Fig. 189—Drawing of a crankcase to be machined and finished on the lathe as described in the text

manipulation of a lathe he will find that it is not so difficult to arrive at the final measurement with the use of the lathe tool only, but until he reaches this degree of proficiency he may find it necessary to resort to the use of abrasive cloth. To finish the roller the lathe is again stopped and the tool is brought into contact with the work one inch from the shoulder nearest the head stock.

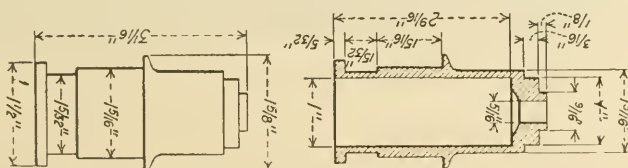

Fig. 190—A model compressor cylinder to be machined

The parting tool is then run through the stock and the finished roller can be caught in the hand as it drops off.

This little job, if carried out correctly, will teach the amateur mechanic many things about lathe manipulation and to further his knowledge he is urged to do several

other jobs of this nature before he attacks anything more difficult. When a piece of ordinary stock is placed in the lathe and turned it does not make much difference whether or not it is spoiled, but when a piece is put in which cannot be duplicated it is quite a different matter.

Another valuable lesson in lathe turning can be obtained by following the operations necessary to finish the model compressor cylinder and crank case halves shown in Fig. 189 and in the Drawing, Fig. 190. Attention will first be directed to the turning of the cylinder. This is to be bored out exactly 1 in. in diameter. It would be a very easy matter to mount this in the chuck, run a  $63/64$  drill in and follow this with a 1-in. reamer. But both the drill and the reamer are expensive tools and the machining of the little cylinder can be accomplished on any lathe very easily. Like many other things, the cylinder can be machined in more than one way but there is always the easiest, cheapest and most practical way. This is true with few exceptions. The rough casting of the cylinder is first chucked as shown in Fig. 191. After the cylinder is chucked the lathe should be set in motion for the purpose of determining whether or not the cylinder is revolving true. This can be determined by bringing a piece of chalk up to the round portion of the cylinder until it touches. If the chalk does not produce a mark all the way round the cylinder, it is not running true. It can be brought to proper position by tapping it with a hammer very lightly, or, if this is not effective, it can be taken out of the chuck and turned around. The boring tool is then inserted in the tool post, brought to the proper height, tightened, run up to the mouth of the cylinder and a light cut taken as far as the tool will go. The tool is then withdrawn and another light cut taken.

This cutting operation is continued until the cylinder approaches the correct diameter. The inside calipers are then used frequently. When the cylinder is approaching the final diameter, it will be well to take the tool out of the post and sharpen it on a grinding wheel. To put a very good edge on a small hand stone should be rubbed over the point of the tool. It is again inserted in the tool post and the final cut taken. In taking this final cut the

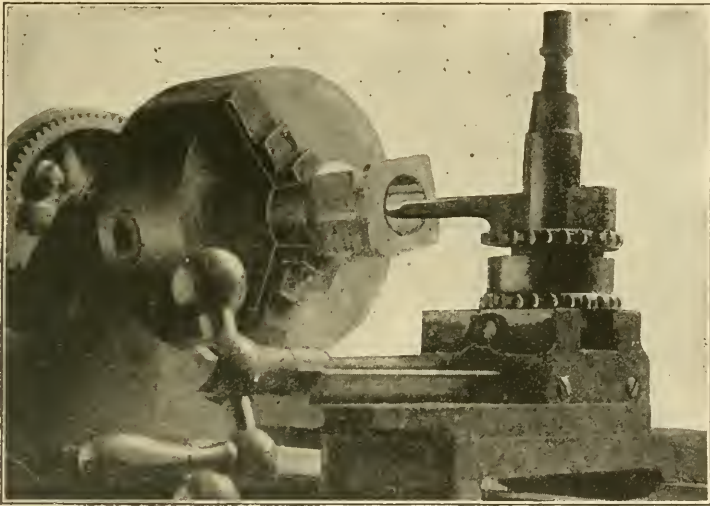

**Fig. 191—Boring out the compressor cylinder on the lathe**

tool should travel very slowly so that a nicely finished surface will result. The boring tool is then replaced in the chuck with a left-hand facing tool and the base of the cylinder is then nicely faced off. When this is done the cylinder is taken out of the chuck. A wooden mandrel or stick is turned to a diameter of approximately 1 in. and forced into the cylinder. A mandrel is a rod or cylinder upon which work is placed to be turned. Mandrels are generally made of steel and they are used

only with work which cannot be held in the chuck. If the outside of the cylinder being turned had to be perfectly accurate a wooden mandrel would not be used, but in this case all that is desired is a finished outer surface and no special attention need be paid to extreme accuracy. The wooden mandrel should make a very tight fit into the cylinder so that it will carry the cylinder around without slipping while the cut is being made. (See Fig. 192.) The top of the cylinder is drilled out

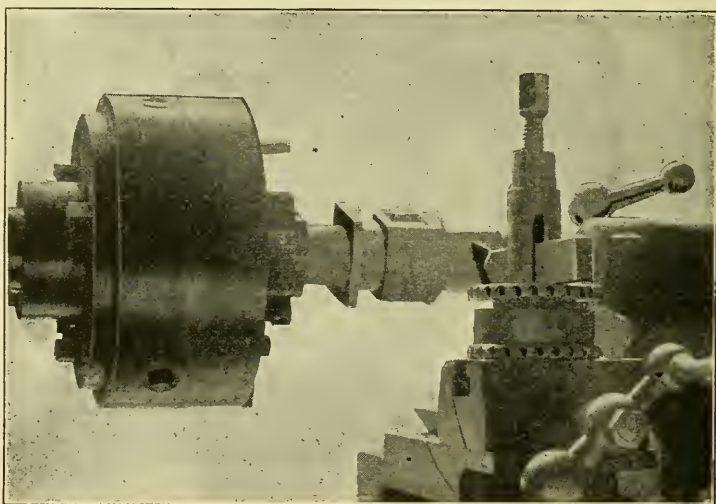

**Fig. 192—Turning the outside of the cylinder on a wooden mandrel**

with a centering drill and the center is inserted in this to further support the work of the mandrel. The diamond-pointed tool is then used in bringing the outside of the cylinder to the proper dimensions. In cutting the shoulders at the top of the cylinder it is well to substitute the parting tool for the diamond-pointed tool. The base of the cylinder is, of course, faced off with the left-hand facing tool. This completes the lathe work on the

cylinder and the crankcase halves will be considered next.

The inside of the crankcase halves should be faced up first. To do this each half is held in the chuck by means of the hub, as shown in Fig. 193. The proper diameter is produced with the boring tool and the facing of the inside is done with a round-nosed tool. The outer surface is faced with the left-hand facing tool.

The drill chuck is then inserted in the spindle of the tail stock and a  $\frac{1}{2}$  in. drill inserted. The tail stock is is

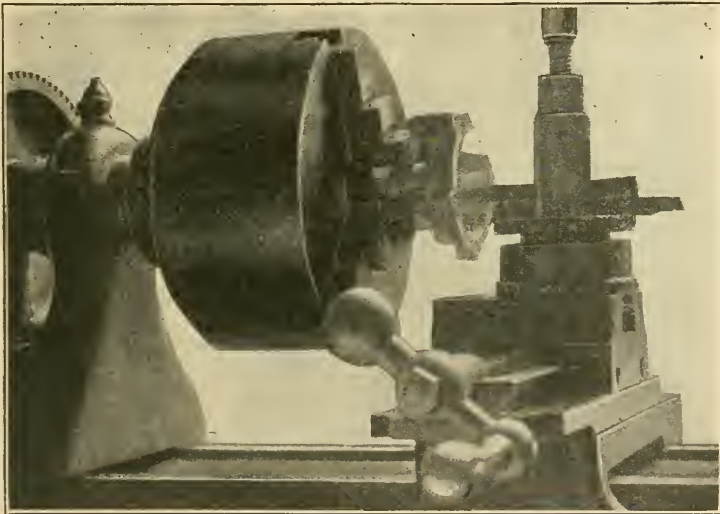
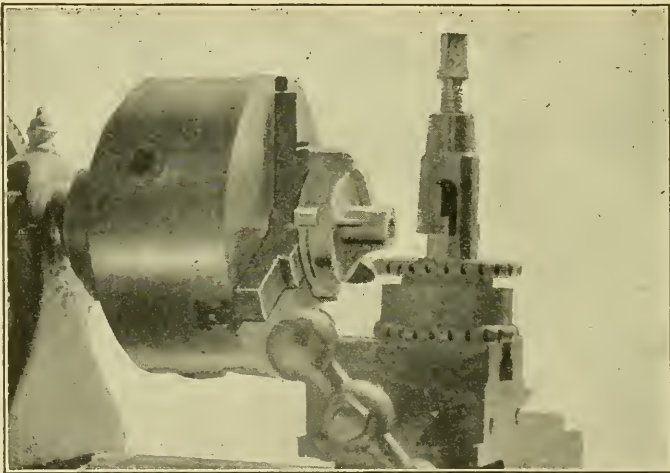

Fig. 193—Turning out the inside of one of the crankcase halves

then brought to the proper position and the inside of the hub or casting is drilled out to accommodate the brass bushing which is to be inserted later. When this is done, the casting is taken out of the chuck and turned around. The end of the hub is then faced off true. It will be seen that the casting is re-chucked by opening the jaws instead of closing them. In doing this, the casting should be pressed tightly against the shoulders of the chuck.

Brass bearings or bushings which fit into the hubs are to be made. A piece of brass stock should be inserted between centers and turned down about  $1/1000$  of an inch larger than the size of the drill used in making the hole in the hub. Two pieces the proper length for the bearings are then cut off with the parting tool. These pieces are then put in the chuck and their center is drilled out with an  $11/64$  drill. The bearings are then ready



**Fig. 194**—How the crankcase halves are mounted for facing off the hub

to be forced into the hub and as they are oversize it will be necessary to apply some pressure in doing this. The vise will be found very convenient in driving these bearings to their proper position in the hub. When this is done, the crankcase half is remounted in the chuck as shown in Fig. 194. A  $3/8$ -in. reamer is then used to ream the  $11/64$ ths hole out. This reamer is held in the lathe as shown at Fig. 195. It is mounted in this manner so that it will follow the hole. Of course, there would be

no serious objection to mounting the reamer in the large chuck and mounting the crankcase half on the drill pad. However, the procedure outlined must be acknowledged to be more practical. After the hole is reamed out a left-hand facing tool is mounted in the tool post and a very light cut taken off the end of the hub. This is to make the bearing perfectly flush with the casting. When this is done, the casting is turned around and the same operation performed on the other side of the hub.

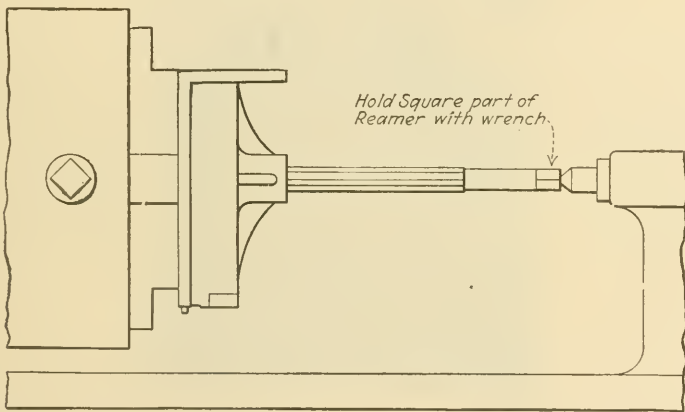

Fig. 195—How the bearings of the crankcase halves are reamed out

What the author desires to do in this Chapter is to teach the mechanic to use his head—a thing which every good mechanic must learn to do. As before stated there are always several ways of doing a thing, but in most cases there is the most practical method. For this reason, the mechanic should always carefully analyze his job before he decides definitely upon a method of procedure.

Many times the inexperienced mechanic has an awkward part to machine and he is generally at a loss to

know just how to mount it in the lathe for turning. The seasoned mechanic has a peculiar instinct which tells him just how to overcome this obstacle which causes the beginner such a great amount of trouble. The following paragraphs will be devoted to the turning of odd-shaped pieces.

When an odd-shaped piece is to be turned, the mechanic should first determine whether or not it is possible to

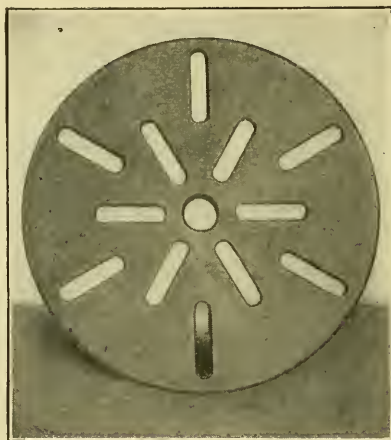

Fig. 196—A large lathe face plate

mount it upon the face plate of his lathe. The face plate of a lathe is provided with various slots and by the use of small carriage bolts it is possible to mount various-shaped pieces upon it. A face plate is shown in Fig. 196. In putting the face plate upon the lathe the threads and the nose of the lathe should be wiped off carefully and the internal threads of the face plate should also be cleaned carefully in order to prevent a chip of metal from getting between the face plate and the lathe spindle. This would cause the face plate to run out of true.



A very simple use of the face plate is shown at Fig. 197. This shows how a small flywheel is mounted on the plate for facing off. The small clamps are made from steel

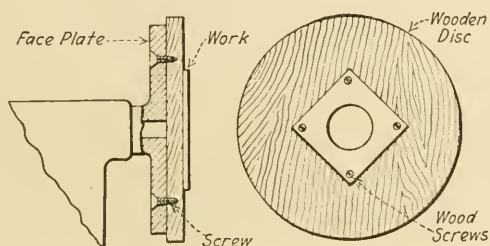

Fig. 197—How a piece of sheet metal may be turned out on the lathe stock and provided with holes through which the small carriage bolts pass. The bolt passes through the face plate with the threaded end on the outside so that the nuts can be tightened conveniently. Before the nuts are

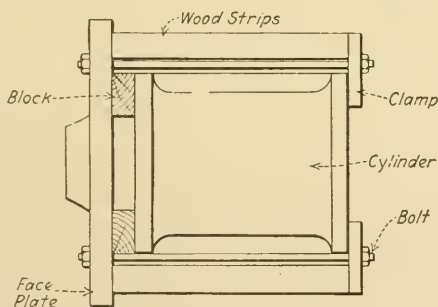

Fig. 198—How a small cylinder is mounted for boring

tightened, however, the wheel should be made to run true and oftentimes this can be facilitated by putting the center in the head stock spindle. If the wheel was being faced off it would be turned around when one side was done and remounted for the turning of the other side.

Another use of the face plate is shown at Fig. 198

where a small cylinder is mounted for boring. Large carriage bolts are used in connection with steel clamps. The outer edges of the clamps are supported by strips of wood which prevent them from slipping off the edge of the cylinder. It will also be noticed that two small strips of wood are interposed between the face plate and the cylinder. This is to provide space for the boring tool to protrude after it has finished the cut in the cylinder and it is very important that this be done. Otherwise the tool will destroy the surface of the face plate.

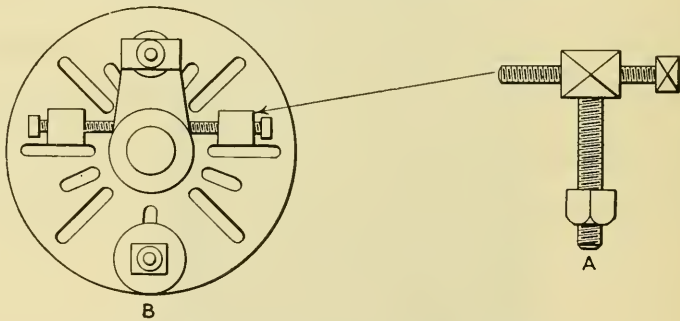

Fig. 199—Holding bolts for use on a face plate

Clamping bolts greatly increase the usefulness of the ordinary face plate. Such a bolt is shown at Fig. 199 A, and at B the use of clamping bolts is made clear. Here they are holding a small crank in place while the hub is being faced off. In turning a job of this nature it will be necessary to place a counter-weight on the opposite side of the face plate. Otherwise the lathe will vibrate excessively. Excessive vibration is very bad for a lathe. Not only does it destroy its accuracy but it decreases its useful life. It is well for the mechanic to have an assortment of counter-weights on hand of various sizes so that one or a combination of several can be found for practically any job. Such weights can be very easily made

by drilling out the center of a piece of one-inch cold rolled steel. Different weights can be made by cutting various lengths. Once the counter-weight is put in place, it should be adjusted until the vibration is eliminated.

An angle plate is absolutely necessary in accomplishing certain jobs on the lathe. The use of an angle plate is shown at Fig. 200. The plate itself is bolted to the surface plate and the work in turn bolted upon the angle plate. It will be seen that a small elbow is being turned at Fig. 200. The angle plate should have several holes drilled in it so that various-sized pieces of work can be accommodated either by the use of bolts or with bolts and clamps combined. It will be seen that such an angle

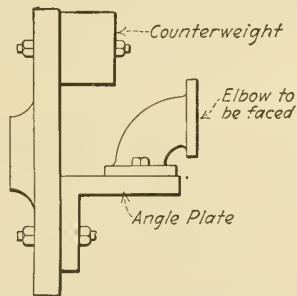

Fig. 200—An elbow mounted for facing on a face plate

plate must have its surfaces at exact right angles to each other, otherwise it will be practically useless in turning work accurately. The elbow mounted on the angle plate in Fig. 200 must have its surfaces protruding over the edge of the plate so that it will come in contact with the cutting tool. Owing to the fact that the angle plate is not centered on the face plate it will be necessary to use a heavy counter-weight to prevent vibration.

Still another use of the angle plate is shown at Fig. 201. Here a small, split bearing is being faced off. Two

bolts pass through the holes in the bearing halves and hold them to the angle plate, in which position they are accessible for turning. It will be found that the angle plate is an extremely useful device for many odd jobs and although lathes are not supplied with this attachment the mechanic will do well to make a simple pattern and have one cast at the foundry.

Wooden blocks are very useful in turning certain odd-shaped pieces of work and the mechanic should have an assortment of blocks on hand at all times. With an assortment of blocks and carriage bolts of various sizes and lengths the mechanic is prepared to turn a multitude

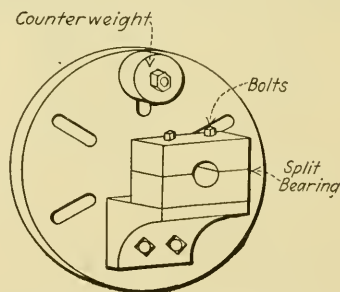

Fig. 201—A split bearing mounted on a face plate with counter weight in place

of odd-shaped castings that it would otherwise be quite impossible to work with. The use of blocks is shown at Fig. 202. Here a small face plate is to be surfaced. Owing to the fact that the angle plate must be provided with several holes, those to accommodate the carriage bolts were drilled first to facilitate mounting the device upon the face plate. Two blocks cut from 2 x 4 stock were used. The bolts seen protruding pass completely through these blocks and the blocks in turn are held to the face plate by two more bolts, the heads of which rest in depressions made in the surface of the blocks, so

that the angle plate will rest square. The two large blocks are held apart with two small strips of wood. The

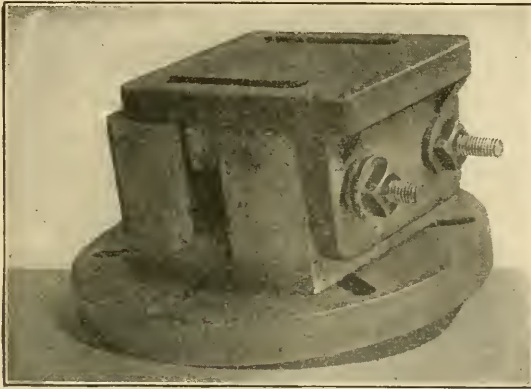

Fig. 202—The use of blocks in mounting an angle plate to the face plate for machining

method of mounting will be made very clear by referring to the sketch at Fig. 203. The angle plate should be

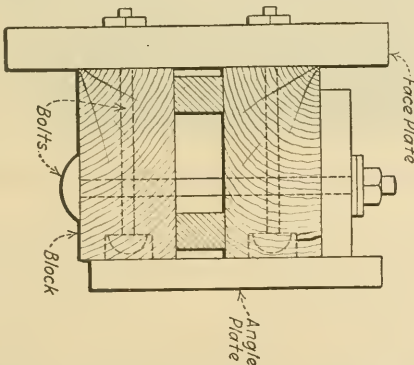

Fig. 203—How the bolts are placed for holding the angle plate to the face plate

bolted very rigidly with no play whatsoever. The angle plate mounted upon the lathe is shown in Fig. 204. Be-

fore the turning is started the square should be laid on the bed of the lathe and its edges brought against the surfaces of the angle plate to determine whether it is perfectly square or parallel with the surfaces of the face plate. If it is not, thin pieces of sheet brass can be placed under one block or the other until the plate is brought into the proper position.

The mounting of this angle plate is a good object lesson in showing just what can be done by the use of blocks of wood. The mechanic should never decide that it is

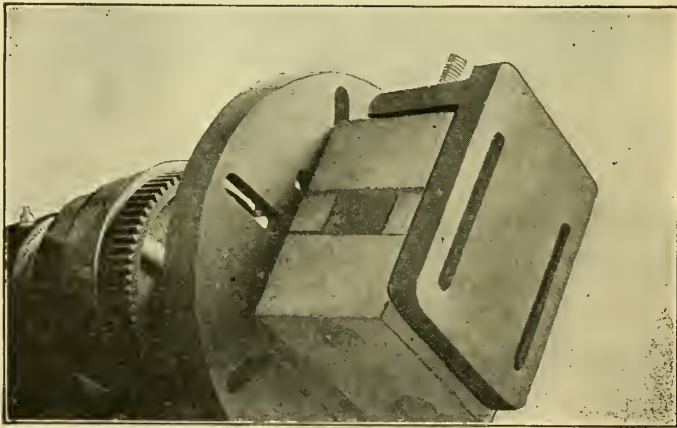

Fig. 204—The angle plate mounted on the lathe

impossible to do a certain piece of machining until he has figured out the possibility of employing blocks and bolts to mount it on the lathe.

Sheet metal can be turned on the face plate as shown in Fig. 205. First, it will be necessary to cover the face plate with a piece of hard wood. This is screwed to the face plate, as shown, and in turn the metal to be cut is screwed to the wooden surface. The mechanic is warned

to fasten the sheet metal to the lathe very securely, as it will cause great injury to anyone it happens to strike if it flies off while the lathe is traveling at high speed.

The turning of a small eccentric is shown in Fig. 206. A single bolt passes through the hole in the eccentric and held in this manner it can be machined. Interposed between the face plate and the eccentric is a thick washer which enables the lathe tool to machine the edge nearest

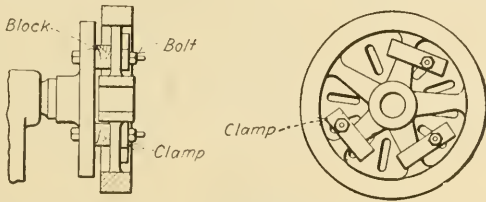

Fig. 205—The use of clamps in holding a flywheel to the face plate the face plate. In mounting such an eccentric upon the face plate it will be necessary to fix it concentrically in relation to the face plate.

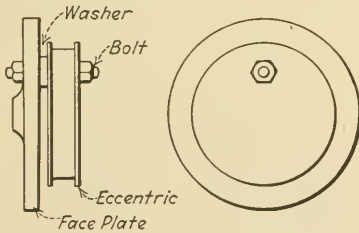

Fig. 206—A small eccentric mounted on the face plate

The turning of a model locomotive driver is shown in Fig. 207. Two small wooden blocks are placed between the flywheel and the face plate. The driver is held to the plate by means of two small hooks which can be bent to shape from a steel rod and threaded at one end to accommodate a nut. The live center of the lathe is put

in place so that the driver can be mounted correctly. After it is machined on one side it can be turned around and machined on the opposite side, being held in the same manner in both cases.

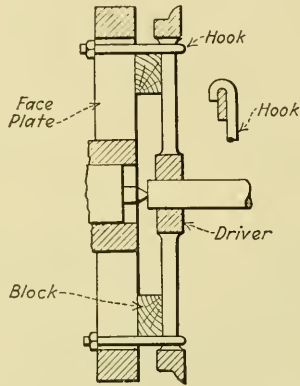

Fig. 207—A model locomotive driver mounted in the lathe for facing

Another method of turning such a driver is shown at Fig. 208. Here the wheel is mounted upon what is known as a mandrel. This mandrel, unlike the one previously

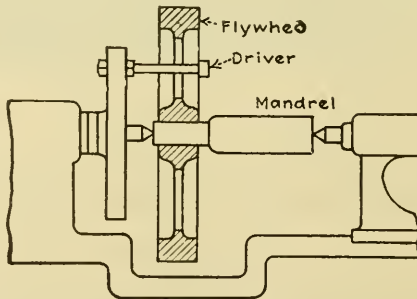

Fig. 208—Driving a flywheel on a mandrel with a bolt placed on the face plate

described is made of steel and the wheel is held in place with a forced fit. The mandrel revolves between centers



and the wheel is driven by means of a bolt or driver arranged as shown in the sketch.

Boring is a very important operation carried out on the lathe, and the mechanic will find many occasions to use what is known as a boring bar. Such a device is shown in Fig. 209. A boring bar is merely a bar of steel with a cutting tool mounted in it. The cutting tool shown in Fig. 209 is a special tool made for the purpose of boring. It is held in a slot cut transversely in the steel bar and a wedge is driven in at the back to hold it in place. The insert shows the shape of the tool and it will be seen that a slight clearance is made on the opposite edges. The real cutting points of the tool are at the corners.

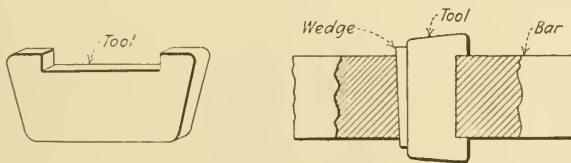

Fig. 209—The cutter of a boring bar

Although such a tool cuts very well it has a serious disadvantage. A tool can only be used for one job as it is not adjustable. If a 2-in. hole is to be bored out the width of the tool at its extreme points must be 2 in. Owing to the fact that the tool is not adjustable, the work has to be done with a single cut and oftentimes this is impossible. If too heavy a cut is taken, the boring bar will twist and therefore inaccuracy will surely result. The boring bar used should always have a diameter as large as possible in order to prevent twisting when a heavy cut is taken.

A boring bar is revolved between centers on the lathe and is generally driven with a lathe dog. Therefore the

work being bored out must be mounted upon the lathe carriage, otherwise it would be impossible to feed the tool into the work, or, what is the same, the work into the tool which is the case with the boring bar. The work of mounting pieces for boring will be treated more in detail in a later chapter.

A boring bar with an adjustable tool is shown in the cross-section, Fig. 210. The cutting tool used is ground to shape from a rod of tool steel and it is held in place with a set screw. It will be seen that this tool is adjustable within very wide limits and therefore a considerable amount of metal can be removed by its use when several

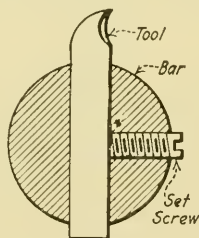

Fig. 210—An adjustable cutter mounted in a boring bar

cuts are taken. It must be remembered that when work is mounted upon the carriage of the lathe the cross-feed cannot be used to adjust the cut. This would result in boring an eccentric hole, therefore it is necessary to adjust the cutting tool on the boring bar. Extremely fine adjustments can be made if the set screw is loosened up and the tool tapped with the handle of a screwdriver and the set screw tightened again.

Another type of boring bar which possesses several notable advantages is shown at Fig. 211. The cutting tool is held in a collar which feeds over the boring bar, the cutting tool being held in place with a set screw.

The collar is adjustable along the bar and is held in any one position by a steel wedge, the collar being provided with a keyway for this purpose. A bar similar to that shown in Fig. 211 must be used for boring large holes. It would be impossible to make a small bar along these lines owing to the fact that the bar upon which the collar

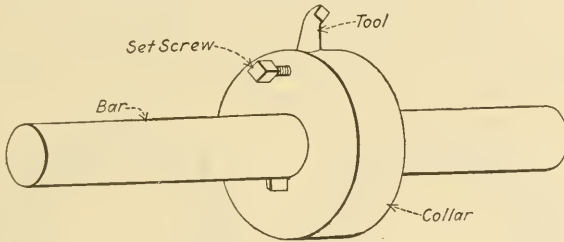

Fig. 211—Another type of adjustable bar

was mounted would be so small that it could not resist the cutting action of the tool.

The author has watched amateur mechanics at work boring holes on a lathe with an ordinary boring tool, and

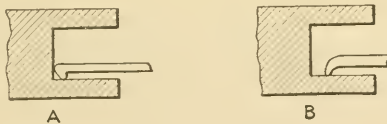

Fig. 212(A)—Improperly ground boring tool  
 Fig. 212(B)—Properly ground boring tool

has often seen them trying to accomplish the impossible by using a tool similar to that shown at A in Fig. 212.

An examination of the drawing will readily show what is wrong with such a tool and why it cannot be used. A properly ground boring tool for such an operation is illustrated at B. With this tool it will be possible to cut to the back face of the work.

Another common mistake is shown at Fig. 213. The tool at A will not cut because its clearance is such that it merely rubs against the surface of the work. A properly ground tool for cutting is shown at B.

Probably the most difficult work for the inexperienced mechanic is the making of small crankshafts for steam engines, pumps, gas engines, etc. This fact holds true both in the case of turning the crankshafts on the lathe or building them up from the steel stock without resort-

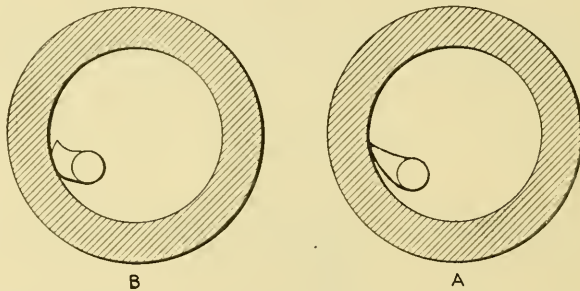

Fig. 213—Two cases of improperly ground boring tools

ing to the lathe. The many hints and the practical information contained in the following paragraphs should enable the most rank and inexperienced mechanic to make crankshafts with every hope that they can really be used on an engine after the job is finished. To the experienced mechanic, of course, the job of turning or building up a small crankshaft is all part of the day's work, and it is not looked upon with fear or uncertainty.

Turning small crankshafts in the lathe is probably more difficult than building them up from stock and for this reason the lathe work will be considered first. If a shaft is to be cut and turned from a solid piece of steel stock, the preliminary cutting, of course, is accomplished

by means of the hacksaw before the work is ready to be mounted between centers to turn the crank pin and the shaft proper. The procedure in producing a small shaft for a single cylinder engine is depicted at Fig. 214. The

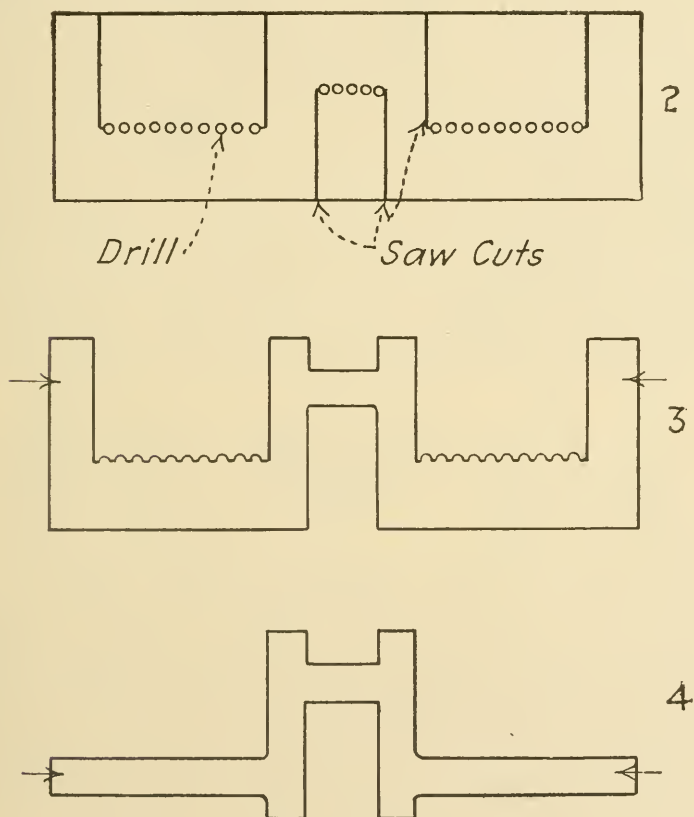

Fig. 214—How the crankshaft is cut out in the rough

first operation is to mark out a facsimile of the shaft on the surface of the steel stock. A small drill is then mounted in the drill press and the holes shown in the sketch are drilled. The hack saw then comes into use and the cuts depicted by means of the heavy lines are

made in the steel. The pieces are then removed with the aid of a cold chisel and a couple of good smart blows from a hammer. When this operation is finished, the shaft is mounted between centers and the turning of the main portions done, the crank pin being left until last. After the main portions of the shaft are turned down to the exact diameter, it is taken off the lathe and mounted upon the centers for the turning of the crank pin. These centers are found in the projecting portions of the steel stock that were left on the original piece for this purpose. Owing to the fact that these projections on the partly finished crankshaft are not substantial, too much strain should not be brought to bear upon them. In case the shaft being turned is very small it might be well to leave

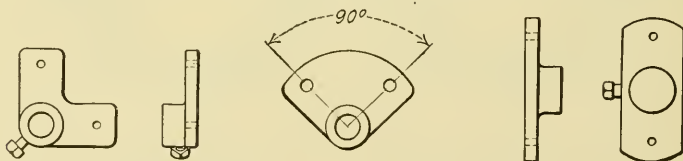

Fig. 215—Several types of end plates for use in turning out crankshafts

more stock on the end so that it would not be too liable to spring which would make the finished shaft fit for nothing but the serap heap under the bench. After the turning of the crank pin is accomplished, the turning and facing of the web faces, both inside and outside is next done, and this is not as difficult as the turning of the rest of the shaft. After the turning operations are completed the shaft is taken out of the lathe and the projecting portions that were used for the centers in turning the crank pin are cut off with a hack saw. The shaft is then remounted in the lathe on the two lower centers and the ends of the shaft finished. This particular procedure

can be avoided by using a larger piece of stock and leaving enough on the end so that it can be cut off without making the finished shaft too short. By this is meant that the overall length of the crankshaft would come between the two outer saw cuts shown in Fig. 214 and the portions beyond that would be entirely superfluous and removed after the crank pin and web faces are turned.

If a single-throw crankshaft is cast and it is desired to turn it down to diameter in the lathe, it will be necessary to proceed differently than when turning a shaft from solid steel stock. Fig. 216 will immediately show the reader how this work is done. The turning of the main portions of the shaft is accomplished in exactly the



Fig. 216—How a small crankshaft can be mounted for turning

same manner employed in the finishing of the crankshaft previously described. It is necessary to make two small end plates for the turning of the crank pin, which are used in place of the projections left on the end of the shaft cut from solid stock. The holes in these end plates are drilled so that they will pass over the end of the shaft snugly and they are further held in place by means of a small set screw. Further reinforcement is offered by using two wooden dowel pins placed as shown in the drawing of the small shaft mounted in the lathe (Fig. 216). The purpose of these wooden pieces is to prevent the end plates from springing, which would probably ruin the shaft if the mechanic was not aware of the fact. This not only prevents the end plates from spring-

ing, but it also prevents the shaft proper from being bent.

The turning of a two-throw or 180-degree crankshaft from a solid piece of steel is not such an easy job as that of turning a small, single-throw shaft. The major portion of the steel from the original piece is removed by the same process as that employed in the making of the first crankshaft. Fig. 217 shows the procedure followed out

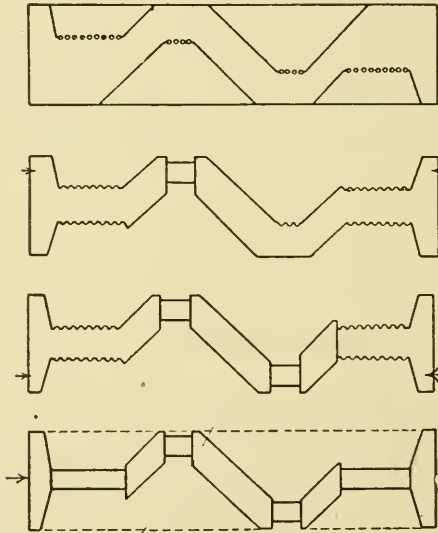

Fig. 217—How a double throw crankshaft is cut from the rough for turning

from the start to the finish. It is, of course, necessary to shift from the centers on one side to the centers on the other to turn the two crank pins. The positions of the centers for the turning of the crankshaft is shown in the illustration. After all the turning is accomplished, the finishing of the connecting portions of the crankshaft is done with the grinding wheel and file. The mechanic



should be careful to prevent the shaft from slipping in his fingers when he is grinding, as the turned portion of the shaft is very apt to be brought into contact with the wheel and this certainly would not do it any particular good.

If a double-throw, 180-degree crankshaft is being turned to diameter from a casting, the end plate at the right in Fig. 215 is employed. It will be seen that this plate is exactly the same as that used in turning the single-throw shaft, but it is made for a double-throw shaft, with the set screw placed in the center. It is well to have these end plates cast with the hubs on them, which prevents inaccuracy in the turning operation. It is a very

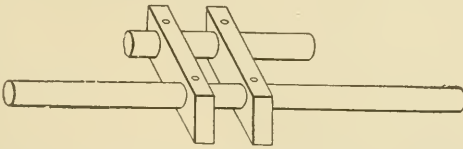

Fig. 218—Method of making a built-up crankshaft

easy matter to make a pattern for the plates and the castings may be made when the shaft is being cast. The end plates should be cast blank so that the holes can be drilled for the size shaft that they are to be used in connection with. A few of these plates can be kept in stock and used for shafts of various sizes. It will be understood that such end plates can only be employed with 180-degree crankshafts. In order to turn 90-degree crankshafts, it is necessary to employ one of the end plates shown in Fig. 215. One of these plates is shown in place on a shaft. In using such plates it is well to reinforce the work with heavy dowel pins as done on the

smaller crankshaft. Some mechanics prefer to have pieces cast on the crankshaft which take the place of the end plates. After they serve their purpose they are cut off. This, however, is not a very economical method, although, from the standpoint of practicability, it may be much better than employing the more conventional type of end plates.

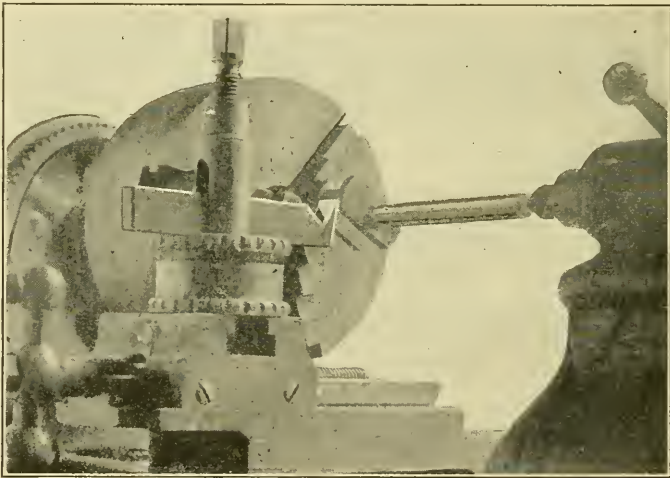

Fig. 219—Turning a small, single-throw crankshaft

We will now turn our attention to built-up crankshafts, which are much easier to produce than those that are turned to diameter on the lathe and therefore they are more apt to appeal to the mechanic who is not sufficiently expert in the use of the lathe to turn out the other type of shaft. Built-up shafts, although not as durable as the solid type, are very suitable for ordinary purposes and if well made, they will hold up under considerable work. The writer has heard of cases where

built-up shafts were used in high-power, high-speed flash steam engines and held up under severe abuse and over-work for some time before finally succumbing.

The crankshaft shown in Fig. 218 is of the single-throw type and is made up from pieces of cold rolled steel stock. The square pieces are first cut to shape and finished up. Assuming that the shaft and crank pins are  $\frac{1}{4}$  in. in diameter,  $\frac{1}{4}$ -in. holes are drilled in the flat pieces. These holes are then reamed out to exact size. It will be necessary to obtain a steel drill rod which is slightly oversize, from .001 to .002 being all that is necessary in this case. This means that the drill rod used should measure .251 to .252 when put through the jaws of the micrometer.

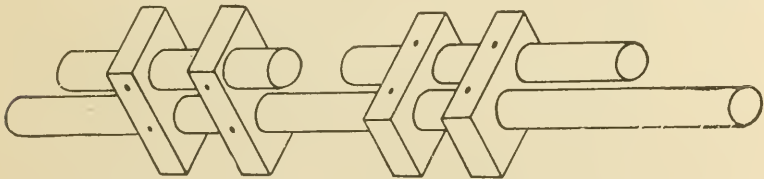

Fig. 220—Method of making a double-throw, built-up crankshaft

The drill rod is then forced through the  $\frac{1}{4}$ -in. holes in the square pieces and this can be done by placing the square pieces in the vise and giving the rod several hard blows with a hammer. The piece for the crank pin is driven in place in the same manner. After this is done, four small holes are drilled in the square pieces and these pass through the center of the shaft and crank pin. These holes should be drilled with a No. 36 drill, and steel pins are driven in the holes and cut off. The superfluous drill rod is then cut away with a hack saw and all surfaces filed down flush. The shaft is now ready for brazing, which is necessary to produce a piece of work that will hold up under heavy strain in actual operation.

At the shaft end, the brazing spelter is applied to the outside of the webs and at the crank-pin end, the spelter is applied to the inside of the webs. When this work is done, the shaft is finished with a file, by means of which the superfluous spelter is removed. Following this process, it may be necessary to mount the shaft between centers on a lathe (Fig. 219) and turn up the inside web faces and also round the ends of the web pieces if this is desired. If heavy crankshafts of the type shown in Fig. 218 are made, it is advisable to balance them up, making the webs longer and passing the shaft through the center of them. This prevents excessive vibration in a small engine which by no means adds to its life.

The shaft shown in Fig. 220 is made by the same method employed in producing the shaft previously described. This is a 90-degree shaft and it will be understood that any type can be produced by this method. After the shaft is assembled, the superfluous portions are cut away with a hack saw after which the brazing is done. In mounting the web pieces upon the shaft, extreme care must be taken to see that they are placed at exactly 90 degrees apart. If a 180-degree shaft is being made by this method, it will only be necessary to lay the shaft on a surface plate and see that all webs lie flat.

In a fore-running part of this Chapter mention was made of the possibility of forcing small crankshafts out of alignment if means are not provided to resist the thrust of the lathe centers. This can be very easily done, and once a shaft is slightly bent it is a very difficult matter to bring it back so that it will not cause trouble when it is mounted in the engine in connection with which it is to be used. It is best to take the proper precautions at the start. While the small wooden dowel pins pre-

viously described will suffice to prevent the shaft from springing, if they are carefully put in place and cut to the proper length, it is best to employ steel rods for the purpose. Such rods are generally called thrust bolts and they are made according to the following directions: The rods are first cut to the proper length—they should be made at least a half inch shorter than the space they are to fit into. Quarter-inch cold roll steel stock should

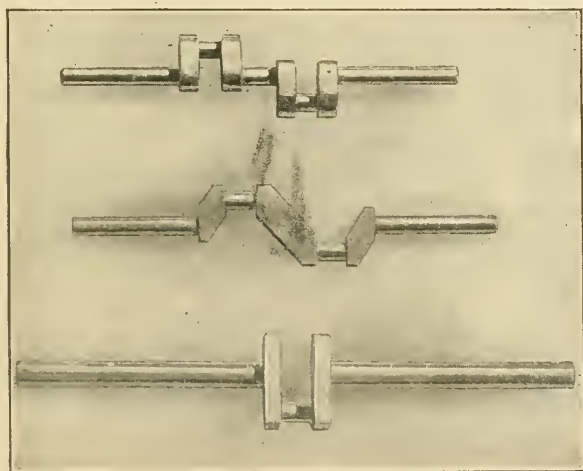

Fig. 221—Three types of crankshafts

be used to make the rods if they are to be used in turning model crankshafts. For larger shafts, larger stock should be used. Each end of the rods is threaded for a distance of at least two inches. A piece of hexagon steel stock about one inch long is then drilled and tapped to fit the rod. One of these large nuts is made for each end of the rod. After they are put in place on the rod, it will be seen that by turning them back and forth, an adjustable rod is obtained. This will enable the mechanic to insert the rod in its place and adjust it to the proper

“tightness.” It will be seen that tightening the nuts too much will be worse than a remedy as this will also cause the shaft to spring. The mechanic must use his own

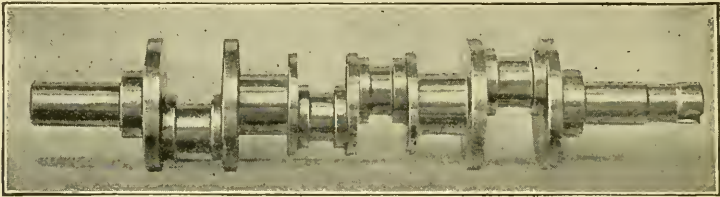

Fig. 222—A four-throw crankshaft turned from the solid

judgment in gauging the proper degree to which the nuts should be adjusted for accurate work.

The crankshaft illustrated in Fig. 222 forms rather a difficult piece of lathe turning and the following outline will give the reader a very good idea of just how it is ac-

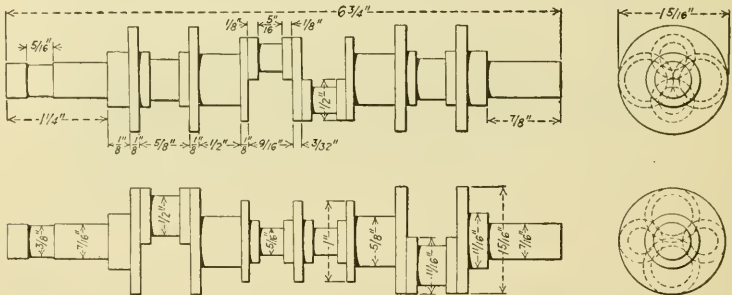

Fig. 223—The dimensions of the crankshaft shown in Fig. 222

complished. The stock required is a piece of cold roll steel  $1\frac{3}{8}$  in. in diameter by  $7\frac{1}{2}$  in. long. The extra length is used in mounting it in the lathe dog.

First the stock is placed in the lathe chuck and the ends carefully faced off. Center holes are then drilled and the stock mounted between centers, driven with the lathe dog. When this is done a light cut is taken and the extra

1/16th in. in diameter cut away bringing the stock to exactly 1-5/16 in. in diameter. This is done to make the stock perfectly true and accurate in relation to the centers. This done, the crankshaft is taken from the lathe, set up on V-blocks and the various centers for the eccentric parts are marked out. These centers will be seen by referring to Fig. 223. First a surface gauge is adjusted so that it will scratch a line directly through the center of the stock. The stock is then turned around to exactly 90 degrees and another line, at right angles to the first is drawn through the center. In this particular crankshaft there are two valve eccentrics and two crank pins. The crank pins are 180 degrees apart and the valve eccentrics are also 180 degrees apart. The valve eccentrics and the crank pins are 90 degrees apart. To find the centers for both the crank pins and the valve eccentrics, a square is scratched on both ends of the stock as shown in Fig. 223. It will be well to mention here that both ends of the stock are marked and the same adjustment for the surface gauge can be used for each end. With this square drawn upon the ends of the shaft the centers for the various eccentric parts can be marked with a center punch at the points where the four lines of the square intersect the first two lines which were drawn 90 degrees apart on the shaft. The various centers for the eccentric parts are then drilled with a centering drill. It will be necessary to do this on a drill press or with the drill pad mounted in the lathe and the centering drill placed in the chuck.

When this work is completed the stock is replaced in the lathe and caused to revolve upon one of the crank-pin centers. With the stock revolving eccentrically, the cutting is started and the proper distance of the cutting

tool from the end of the stock can be found by the use of the scale. The one eccentric is then turned to shape. When this is completed the shaft is taken out of the lathe and mounted in the centers opposite to those just used. Then the other crank pin is turned. This accomplished, the crankshaft is again taken from between centers and mounted on one of the valve eccentric centers. This is turned and the shaft is again remounted on the opposite valve eccentric center and the second eccentric is turned. The shaft is finished by removing it and mounting it be-

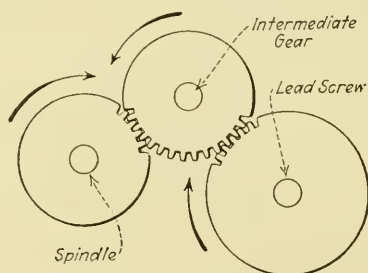

Fig. 224—How the gears are arranged on the lathe for screw-cutting

tween the original centers which are in the center of the stock. The central portions of the stock are then removed, leaving the crankshaft in the shape shown in Fig. 222.

At this juncture it will be well to consider screw cutting. In referring to screw cutting in a previous chapter of this book, it was mentioned that screw cutting was accomplished by causing the lathe carriage to travel along the bed of the lathe at a definite rate of speed by means of the lead screw and a train of gears connecting the lead screw with the spindle of the lathe. A simple train of gears used for this purpose is shown at Fig. 224. By using gears of various diameters it is possible to cause the lathe carriage to move at different speeds. The speed



at which the lathe spindle moves determines the pitch of the thread; the faster the carriage travels the coarser the threads will be and the slower it travels the finer the threads will be. The intermediate gear, between the gear on the spindle of the lathe and the gear on the lead screw, does not influence the speed of the lead screw but merely acts as a transmitter of the motion. The proper speed is arrived at by choosing gears with the proper ratio to be mounted upon the lead screw and the spindle. If a thread with a large pitch is desired a large gear is used upon the spindle and a small gear upon the lead screw and if a thread of a small pitch is desired a small gear is mounted upon the spindle and a large one upon the lead screw. The method of mounting the gears is different with different lathes. Each manufacturer has his own particular method of arranging the gears and no definite set of rules can be given. If the mechanic will study his lathe and read his instruction book he will soon learn the method of putting them in place. In mounting the gears they should be made to mesh freely without binding and it will be found that the spindle for one of the gears is adjustable so that the various combinations can be employed.

There is a little brass index plate on the side of each lathe which shows the necessary gears to cut the desired thread. The arrangement of a typical plate is shown in Fig. 225. If the mechanic refers to this plate when he has a thread to cut he cannot possibly go wrong. The columns are headed "Thread," "Spindle" and "Screw." The numbers in the "Thread" column refer to the pitch, running from 4 to 40, and the numbers under the "Spindle" column show the proper gear to use for each pitch. The number really refers to the number of teeth in the

## HERCULES LATHE CO.

| THREAD | SPINDLE | SCREW |
|--------|---------|-------|
| 4      | 64      | 32    |
| 5      | 64      | 40    |
| 6      | 64      | 48    |
| 7      | 32      | 56    |
| 8      | 32      | 32    |
| 9      | 64      | 72    |
| 10     | 32      | 40    |
| 11     | 32      | 44    |
| 11½    | 32      | 46    |
| 12     | 32      | 48    |
| 13     | 32      | 52    |
| 14     | 32      | 56    |
| 16     | 32      | 64    |
| 18     | 32      | 72    |
| 20     | 32      | 80    |
| 22     | 16      | 44    |
| 24     | 16      | 48    |
| 26     | 16      | 52    |
| 28     | 16      | 56    |
| 30     | 16      | 60    |
| 32     | 16      | 64    |
| 36     | 16      | 72    |
| 40     | 16      | 80    |

Fig. 225—Lathe Index Plate

gear. In the "Screw" column, the numbers refer to the gear which is to be used upon the lead screw. If a thread with a pitch of 12 was to be cut, a gear with 32 teeth would be placed upon the spindle of the lathe and one

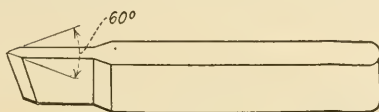

Fig. 226—The method of grinding a screw-cutting tool

with 48 teeth would be placed upon the lead screw, with the intermediate gear placed between them. As before mentioned, the diameter of the intermediate gear is immaterial as it is only used to transmit the motion between the lead screw and the spindle gears.

The carriage is connected with the lead screw by the splined nut which was described in Chapter 5. The splined



Fig. 227—A gauge used in grinding a screw-cutting lathe tool

nut is tightened about the lead screw by a small handle on the lathe apron. Immediately the nut is tightened about the lead screw the carriage moves toward the head stock and if a thread-cutting tool is mounted in the tool post, threads can be cut.

A thread-cutting tool is shown in Fig. 226 and if it is used to cut U. S. standard threads it must be ground at exactly 60 degrees. The little gauge shown in Fig. 227 is used when grinding the tool. The point of the tool is ground until it will just fit into the indentation at the end of the gauge. By holding the tool and gauge up to the light it is possible to get a very close fit.

The tool is then placed in the tool post and adjusted so that it will be at exact right angles to the rod or work to be threaded. The method of adjusting the tool to the proper angle is shown in Fig. 228. With the tool adjusted properly the first cut is ready to be made and at

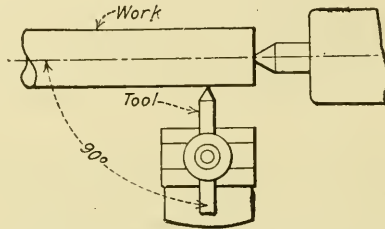

Fig. 228—How the screw-cutting tool should be set in the lathe

this point it is well to mention that a thread is not made with one single cut of the tool. The first cut should be very light, and with the splined nut loose and the carriage still, the cross feed is adjusted until the tool will just feed into the work lightly when the lathe carriage is advanced. The split nut is then tightened and the carriage

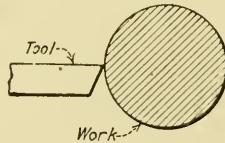

Fig. 229—The screw-cutting tool should be mounted at the exact center of the work

will be thrown into motion. When the tool is advanced the proper distance where the thread is to end, the nut is loosened and the carriage run back to its starting point or the lathe can be thrown into reverse and the carriage will automatically travel back. Another light cut is then taken and still another if the thread is a large one. The number of cuts will depend entirely upon the pitch of the thread and the stock being cut. If a very fine thread

is being cut upon brass it may be necessary to take only two cuts. It would be advisable, however, to take more than two cuts on a piece of steel. The thread-cutting tool should always be placed at the exact center of the work as shown at Fig. 229, otherwise the thread will not be cut accurately.

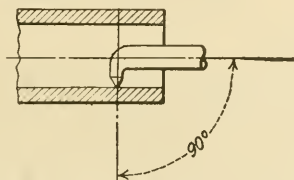

Fig. 230—How the inside screw-cutting tool should be mounted

Internal threads are made with what is known as an inside thread-cutting tool. Such a tool and its use is shown at Fig. 230.

Oftentimes the mechanic has a thread which he desires

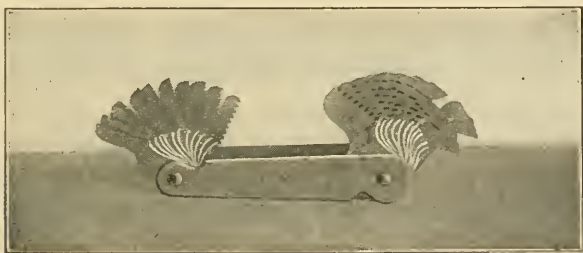

Fig. 231—A thread gauge

to duplicate, and to do this he must know the pitch of the thread in order to make his proper gear selection. The little thread gauge shown in Fig. 231 must be used in determining the pitch of the thread. The gauge is provided with blades and each blade has teeth in it which represent a screw with a certain pitch and the pitch is stamped on the side of each blade.

## CHAPTER VII

### Special Lathe Work

Boring long holes—Use of D-bits—Construction of D-bits—Mounting gun barrel for drilling—Use of D-bit in drilling gun barrel—Reamer to follow D-bit—Cutting key-way on the lathe without milling attachment—Construction of special drilling attachment for use on small lathe—Construction and use of overhead drive for small lathe—Construction of small milling attachment for use on home shop lathe—Milling without milling attachment—Use of various milling devices—Use of special reamers—Home-made lathe tools for special purposes.

THERE are many special jobs which can be performed on a lathe by the aid of a few simple tools which can easily be made by the amateur mechanic. The tools described in the ensuing paragraphs will increase the usefulness of the lathe very much and by their aid work can be done that could not be accomplished otherwise.

The problem of boring long holes of small diameter on a lathe has always been a difficult one for the average mechanic. The following notes will do much to lay bare the secret of the work and to enable the mechanic to proceed intelligently with the operation.

For the sake of convenience, it is assumed that a .250 hole is to be bored in a model gun barrel measuring 6 in. The barrel of the gun is of cold rolled steel and the bore must not only be accurate in size, but perfectly concentric in relation to the outer diameter.

To bore a hole of this nature, it is necessary to make two special tools. The tool commonly used is a D-bit.

Such bits were used long before the conventional fluted drill came into use. It is interesting to know that a D-bit, if properly made, will drill a hole with greater accuracy than a fluted drill. Of course, the D-bit is not able to drill a hole as quickly as a fluted drill, and, for this reason it is not used commercially.

A D-bit is shown in Fig. 232 and its extreme simplicity will be noticed. It must be very accurately made in order to do its work effectively. In fact, the accuracy required is so great that a few thousandths of an inch make a considerable amount of difference and may render the tool entirely useless. To make a .250 hole, it will first be necessary to make a D-bit that will drill a hole slightly

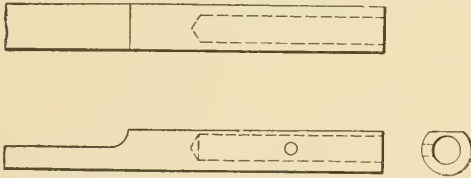

Fig. 232—A D-bit, showing its construction

under this diameter—about  $7/32$  in. The general proportion of the D-bit is an important matter. The length of the complete tool will depend entirely upon its diameter. The length of the forward or cutting portion of the tool should be approximately three times the diameter, while the shank should be about six times the diameter. The plain surface or cutting edge must be cut diametrically correct. *Exactly one-half* of the rod from which the D-bit is made must be cut away. If more than one-half is cut, the tool will bore a hole under size, and if more than one-half is left it will bore a hole over size.

In the case of the tool being under size, the shank will

not be able to follow and great trouble will be experienced. The shank of the tool should always be slightly tapered, and in actual practice it will be found that from .001 to .002 of an inch will suffice. The cutting edge should be ground to an angle of approximately 10 degrees, although a little more or less will not seriously impair its efficiency. The cutting action of the tool is shown clearly in Fig. 233. The top of the shank is made

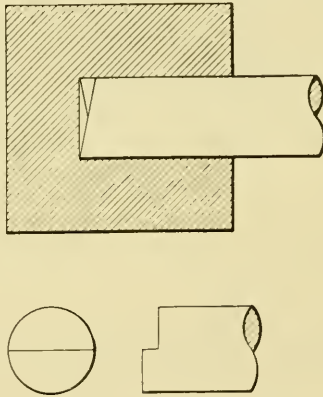

Fig. 233—The action of a D-bit

slightly flat to allow the escape of air and to provide for the introduction of the lubricating substance during cutting. The shank of the tool is drilled out to receive a piece of drill rod with a forced fit. Two pins are then driven through the shank and the drill rod and ground off flush with the surface. An additional security against possible shearing of the pins is made by the application of a few drops of solder on the outer surfaces of the D-bit and drill rod. The drill rod upon which the D-bit is mounted should not be any longer than necessary, as the greater the length the greater the tendency will be to



twist. It must be remembered that it requires considerable resistance on the part of the rod to overcome serious inaccuracy through twisting.

A second D-bit must be made to follow the first one. This should be capable of drilling a hole .248. The construction is identical. After the second D-bit has accomplished its purpose, the hole is reamed out to exact size with a .250 reamer.

Having considered the tool and its construction, attention will now be diverted to its use on the lathe. The D-bit is held in a special holder which fits in the tool post. This holder will be noticed in Fig. 234. It is made from a piece of cold rolled steel drilled and slotted as shown. The bolt on the top is used to draw the jaws of

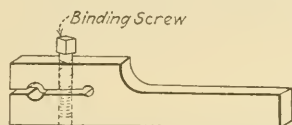

Fig. 234—A special holder for the D-bit

the tool together to tightly hold the D-bit. The bottom portion of the holder is threaded while the clearance hole is made in the top so that the parts can be drawn together when the top screw is tightened. If the gun barrel to be drilled is no longer than 6 in. it may be possible to hold it in the chuck in the ordinary manner, providing the hollow spindle of the lathe used will accommodate it. Great care should be taken to see that the barrel of the gun is running *absolutely true* in the chuck before drilling is proceeded with. The D-bit must also be set accurately and perfectly parallel to the axis of the gun barrel. Having accomplished this, the drilling is proceeded with. The feed is accomplished by putting the

back center of the lathe upon the center of the drill rod which holds the D-bit.

There is one precaution necessary in using the D-bit and that is "Do Not Be in a Hurry." The D-bit is very slow in its cutting and it must not be forced too much. A very liberal supply of lubricating oil should also be applied to the tool at regular intervals. The tool should be withdrawn occasionally to bring out the chips. If the drill has been made accurately the mechanic need not feel anxious about the accuracy of the hole it will make. On the other hand, if the drill has been made inaccurately, accurate results can by no means be expected.

After the  $7/32$ -in. hole has been made, the D-bit with a diameter of  $.248$  is used, and, if accurately made, it will follow the hole previously made perfectly. A liberal supply of lubricating oil should be used when performing

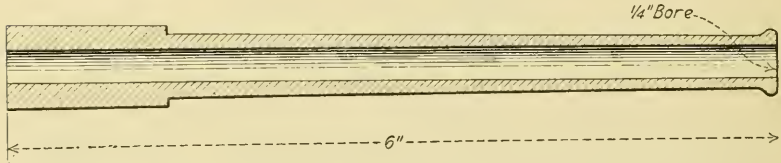

Fig. 235—A gun barrel to be drilled out with the D-bit

this job. When this is done, a  $1/4$ -in. reamer should be used, and it may be necessary for the mechanic to make this reamer unless he can purchase a special one with a small shank. In case it is necessary to purchase this reamer, it can be tapered to a point where it will be possible to drill out the shank and insert the pieces of the drill rod by the same method as was used with the D-bit. However, making the reamer for this job is not as difficult as it may appear. A tool can be made that will cut flutes horizontally and the back gears of the lathe

can be marked with a piece of chalk to take the place of a dividing head. For instance, if six flutes are desired, the 66 gear can be marked out every eleventh tooth.

D-bits of small diameter are more difficult to handle than those of larger size owing to the tendency of the drill rod to twist, and for this reason they are impractical to use for drilling holes over 6 in. in length.

To make this treatment complete it will be assumed that we have a hole to bore about 8 in. long in a tapered gun barrel  $\frac{3}{4}$  in. at the small end and 1 in. at the large end. To use a D-bit on a job like this, it will be necessary to employ a center rest owing to the fact that the

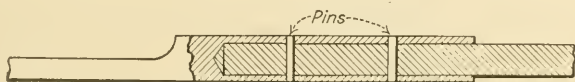

Fig. 236—Method of holding the D-bit to the rod

hollow spindle of the amateur's lathe will not accommodate a piece of stock of this diameter. Therefore, one end of the barrel is mounted in the chuck and the protruding end is mounted in the center rest. Patience should be exercised in seeing that the barrel is running absolutely true before the drilling is started. Otherwise, only disappointment will result, as the finished hole will be seriously out of true. When this has been accomplished, the drilling can be proceeded with in the usual manner.

If a long hole must be bored in a piece of stock that will be accommodated by the hollow spindle of the lathe, it will be possible to mount it in the chuck in the ordinary manner and to hold the drill rod that supports the D-bit in the center rest in place of the stock being drilled. This will tend to correct any inaccuracy that may result from

the drill rod being slightly bent, and this is very apt to be the case if a rod of unusual length is employed.

Keyways can be cut on a lathe with very little trouble by mounting a special ground tool sidewise in the tool

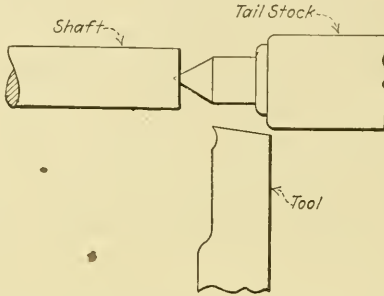

Fig. 237—Position of the tool for key-way cutting on the lathe

post and running it along the side of the shaft which is held between centers on the lathe. This will be made clear by referring to Figs. 237 and 238. As will be seen the tool used is similar to a parting tool, the only difference being that a lip is ground on it. The shaft in



Fig. 238—A hole drilled at the end of the cut will automatically remove the chip

which the keyway is to be cut is mounted between centers in the regular way and the back gears of the lathe are thrown in to prevent it from turning. A hole is made at the point where the keyway is to end. This is done so that the chip at the end of the cut will drop off. When the tool is mounted securely in place its edge is brought to the surface of the shaft and a very light cut taken at the point where the hole is drilled. This is fol-

lowed by several more light cuts until the tool has cut a groove sufficiently deep to guide it in further cutting. When this is done heavier cuts can be taken without danger. The point of the cutting tool should be lubricated with oil during the operation. If a special type groove is desired it may be necessary to use an especially made half center for the lathe so that the cutting tool may be adjusted properly to make the cut.

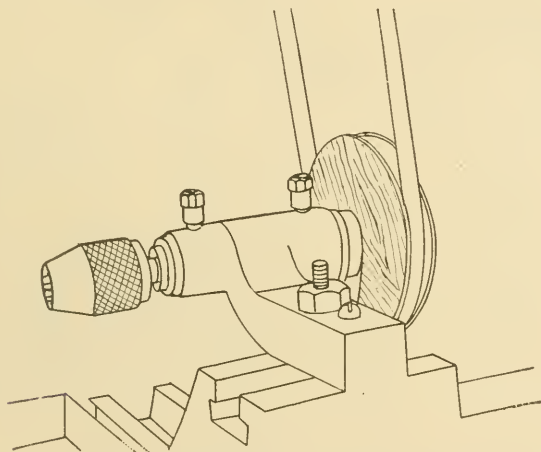

Fig. 239—A drilling attachment for a shop lathe. This can also be used for grinding

A very useful addition to the lathe is shown in Fig. 239. This is a drill spindle made especially to be attached to the cross slide of a small lathe. This little spindle is provided with a chuck which takes drills up to  $\frac{1}{4}$  in. in diameter and by its use many operations can be performed which would be impossible with the ordinary drill chuck used on the lathe. One of its uses is drilling holes in concentric circles. It will be seen that it consists of a casting machined to take brass bushings

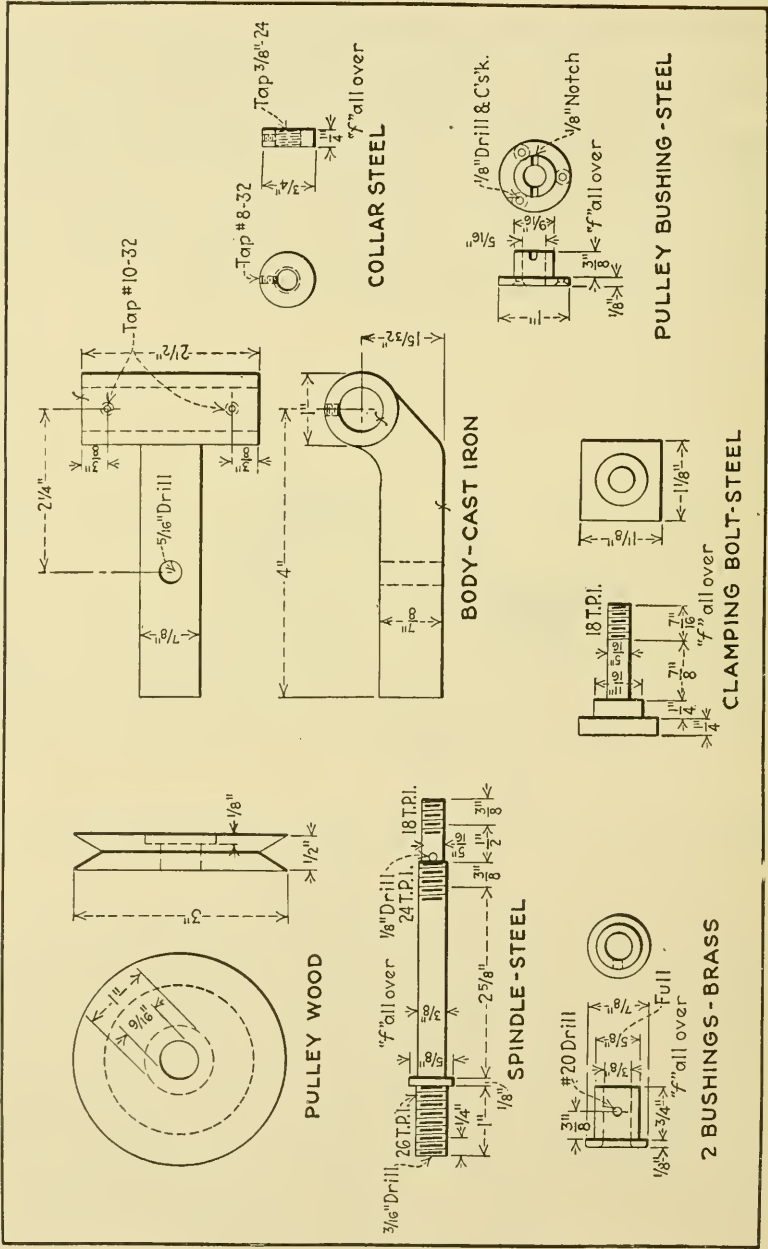

Fig. 240—Detail drawing for the drilling and grinding attachment shown in Fig. 239

in which runs a shaft carrying a chuck at one end and a pulley at the opposite end. A detail drawing of the device is given at Fig. 240 so that the mechanic can set about to make such a tool for use on his lathe. If the

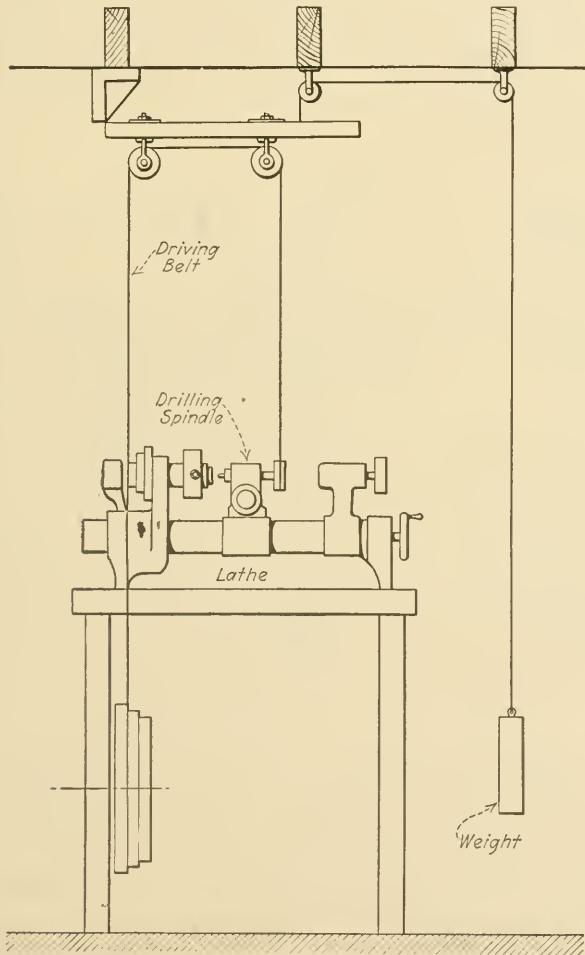

Fig. 241—The arrangement of an over-head attachment for a bench lathe

drill chuck is removed and a grinding wheel placed upon the shaft the attachment can be used for grinding purposes and it will serve for both internal and external work. There is one caution necessary in using the grinding attachment for the lathe: The lathe should be carefully brushed off each time the device is used as the abrasive particles which break off the wheel are very apt to find their way into some vital part of the lathe and cause great harm.

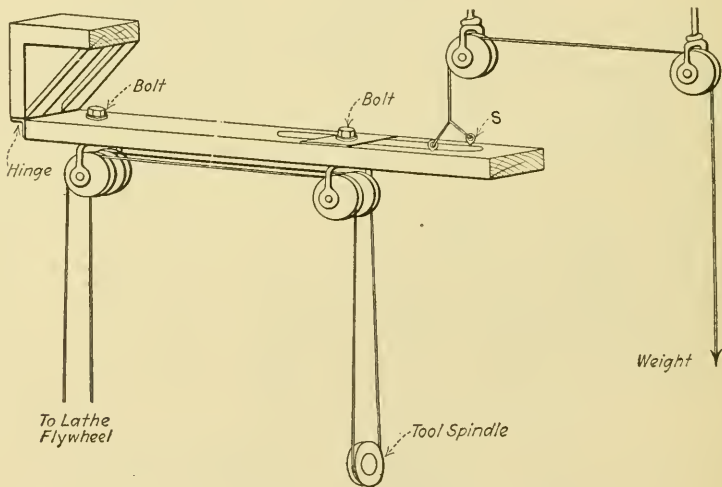

Fig. 242—Details of the over-head attachment

The drilling spindle for the lathe must have some means of driving it. It would be difficult to use an electric motor owing to the fact that the device travels back and forth and the tool rest and belting arrangements would become rather complicated. What is called an overhead gear for use in driving such attachments is shown in Fig. 241 and in detail at Fig. 242. The simplicity of the little device can be appreciated and very little



work is necessary to assemble it for use. If it is mounted on the ceiling the proper distance above the lathe it will be found possible to cause the drill spindle to move back and forth the full distance without slipping off. The belt used can be made of cat gut or thin strips sewed together from pieces similar to those used in lacing belts.

It is possible to do milling on a lathe, provided a mill-

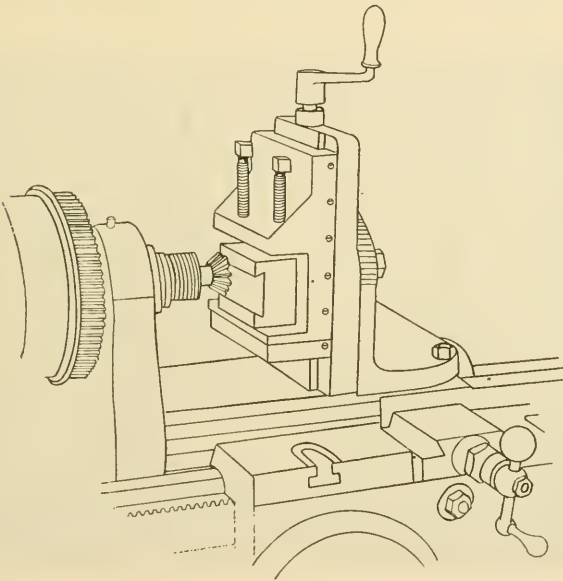

Fig. 243—A milling attachment in use

ing attachment is either purchased or made to mount upon the cross slide. A milling attachment is really nothing more or less than a vise mounted upon the cross slide to hold the work, and what is known as a milling cutter is placed in the chuck or head spindle of the lathe. Each lathe manufacturer is generally able to furnish small milling cutters with standard Morse tapers so that they will feed into the head spindle of the lathe. The vise

or milling attachment must be so arranged that it can be revolved upon an axis at least 180 degrees. A milling attachment will be seen in Fig. 243.

A very simple home-made milling attachment is shown at Fig. 244. This was made by an amateur mechanic for his lathe and the writer is informed that it has proven very satisfactory. A close examination of the attachment will reveal the fact that the compound rest of the

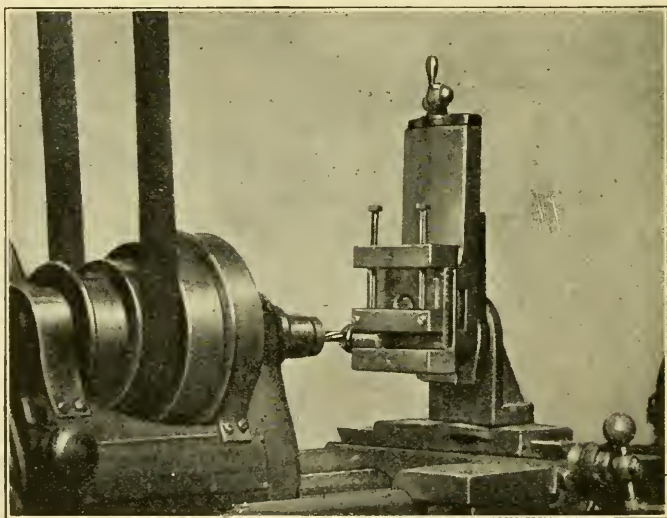

Fig. 244—A home-made milling attachment in use

lathe is used as part of the attachment itself. The compound rest is supported by a special angle plate, which, in turn, is mounted on the cross slide of the lathe in place of the compound rest. This allows the angle plate to be set at an angle with the cross slide as well as allowing the vertical slide (compound rest) to be adjusted similarly with reference to the angle plate. The work is supported on the compound rest either by clamping it to

same or by a vise and table. It will be understood that such an attachment would have to be especially made for the lathe upon which it was to be used. Two feeds are possible, one vertically by means of the ball crank at the top of the compound rest and crosswise by means of the cross slide.

To do milling successfully the lathe should be adjusted to the proper speed and in the case of milling steel the speed of the lathe should not be greater than 150 R.P.M. Brass, however, can be cut faster than this and a greater speed is recommended.

Simple little jobs in milling can oftentimes be done without the use of a milling attachment. For instance, if

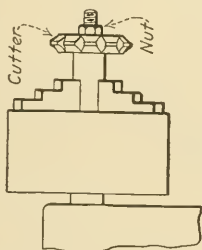

Fig. 245—A milling cutter mounted on a mandrel

a short length of rack is to be made, a milling cutter can be mounted on an arbor and held in the chuck of the lathe while the piece of stock from which the rack is to be made is held in the tool post of the lathe. This will be made clear by referring to Fig. 245. The stock must have enough body to it to resist bending when the cutter starts to cut the groove. It is possible to use a thick piece of stock and grind or file it down to shape, after the cutting is done. This prevents it from bending. Another alternative is to support the stock being cut with a piece mounted in the tool post underneath it. It is not practical to cut long racks in this manner owing to the

fact that the stock would spring when the cutting took place too great a distance from the tool post. Small milling cutters with various-shaped faces can be purchased from tool manufacturers and it will be found that they can be used many times for cutting grooves, etc. The arbor upon which the cutter is mounted should have a diameter slightly smaller than the hole in the center of the cutter so that when mounted in place it will not have a tendency to move through the want of support at the center.

A special reamer, which can be made by the mechanic, is shown at Fig. 246. Such a reamer can be used in connection with the D-bit described in a previous part of this Chapter.

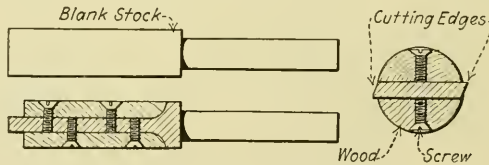

Fig. 246—A reamer made especially to follow a D-bit

Oftentimes it is necessary to finish a long bore smoothly and the average amateur mechanic is generally at a loss as to the most practical method of procedure. In the case of a long hole such as the bore of a model gun barrel, the use of a reamer is rendered difficult and, therefore, it is quite practical to make a special tool that will perform the work accurately. The drilling of a hole of a small diameter with what is known as a D-bit was described in a forerunning part of this Chapter.

The improvised reamer is shown in Fig. 246. To make this, a piece of stock is first mounted in the lathe and turned down as illustrated in the drawing. Care should be taken to turn the larger portion of the tool to exact

diameter—that will be the diameter which the finished bore is to be. It is not advisable to take a cut over a fiftieth of an inch with this tool. Having turned the steel stock to the proper diameter, it is ground or machined flat as illustrated. The machining should leave the cutting portion of the tool about  $\frac{1}{8}$  in. thick. When this is done, the holes are marked out and drilled and tapped for the flat-head machine screws. It will then be necessary to turn a piece of hard wood down to a diameter a little smaller than the steel. This piece of hard wood is then split so that when the halves are placed on the flat portion of the steel cutter they will form a perfect circle. The wooden halves are then drilled out so that the holes will correspond with those on the steel portion of the tool. The holes are counter-sunk so that the heads of the screws will be at least  $\frac{1}{32}$  in. below the surface. Before the wooden halves are finally put in place, the flat portion of the tool is put in a vise and with a smooth file the edges are slightly tapered. In doing this, the mechanic should be careful not to destroy the original diameter of the tool, but merely incline one edge until it just meets the opposite edge. This is done in opposite directions on each side of the tool as will be noticed by a glance at the drawing. Having finished this, the tool is heated to middle straw color and tempered. The wooden halves are then placed on the tool and with the exception of the extension rod upon which the tool is mounted, it is ready for cutting. The extension rod should fit into a hole in the shank of the cutting tool and be fixed there with a steel pin. The extension rod will depend, of course, entirely upon the length of the bore that the tool is to be used in and it should not be any longer than is necessary.

The results obtained by the use of such a tool depend entirely upon how it is handled in the lathe. It should be inserted very easily and advanced into the bore very slowly, well wetted with cutting compound or soapy water.

A variety of home-made tools is shown in Fig. 247. These are tools for special purposes on the lathe and can be made by the amateur mechanic. In the group will be found special reamers, arboring tools and running down cutters. An arboring tool is shown at Fig. 248. Such a tool is used in making a cut similar to that shown in the insert. It will be necessary to provide such a tool with

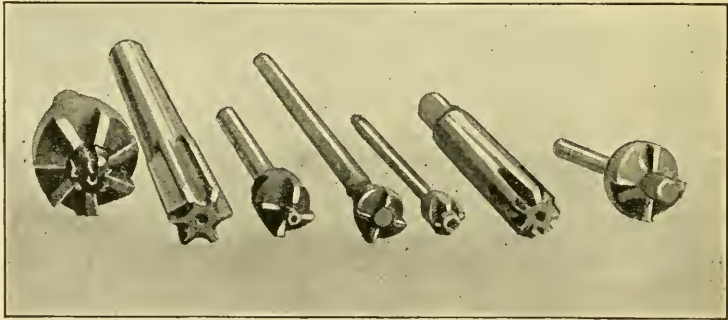

Fig. 247—A number of different cutters for use on a lathe

a pin and a hole a little larger than the diameter of this pin is first drilled in the work. The pin revolves in this hole and thereby keeps the arboring tool on center. Such an arboring tool can be made from a piece of tool steel turned to the proper diameter and the cutting edges or notches filed in. When this is done the tool can be hardened and mounted upon the arbor. It will be impossible to drill deep holes with such a device.

A running down cutter is shown at Fig. 249. This is used to cut down the diameter of rods when repetition

work is being done. By its use both great speed and accuracy are possible. The use of the tool is shown in Fig. 250. It is possible to remove as much as 50 per cent of the stock with such a simple little cutter.

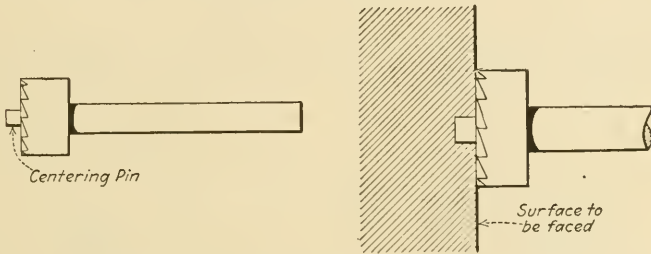

Fig. 248—A home-made arboring tool

The home mechanic can easily make his own running down cutter by obtaining the steel stock and turning it down to the proper diameter. The center is then drilled out with the correct sized drill and the cutting edges made



Fig. 249—A small running-down cutter that finds many uses

with a file. In producing these care should be taken to see that they all have the same rake. Otherwise the tool will not cut accurately. When the cutting edges or notches have been filed in the drill should be hardened. When it becomes dull it is possible to restore its cutting efficiency by the use of a small hand stone.



Fig. 250—How a running-down cutter cuts

## CHAPTER VIII

### Grinding Operations

Grinding and polishing head—Choosing small grinder for shop use—Speed for grinding work—Proper speed for polishing work—Driving the grinding head—Abrasive wheels—Physical characteristics of abrasive wheels and abrasives—Explanation of grit—Grade—Bond—Special grades—Choosing wheels for different work—Wheel faces—Precautions in mounting wheels—Testing wheels before mounting—Maintaining wheel faces—Restoring wheel faces—Dressing wheels—Simple wheel dresser—Grinding—Lapp grinding—Use of the lathe as a lapp grinder—Abrasive paper—Abrasive cloth—Lapp board—Simple grinding appliances—Abrasive powders—Abrasive grains—Use of powders and grains—Buffing—Buffing materials.

ABRASIVE wheels and material are widely used to-day in the industrial world and special machines and appliances are made for various operations such as cylindrical grinding, lap grinding, surface grinding and internal grinding. Owing to the fact that none of these special machines will be found in the small home shop the author will not describe their use. A small grinding head provided with several abrasive wheels of different grits together with a few hand stones and abrasive cloth is about all the home mechanic needs in his work. All these materials can be purchased for a few dollars. The information imparted in this Chapter will deal with a simple abrasive equipment especially for the small shop and with which many different operations can be performed not only with increased speed but with greater accuracy than is obtainable by older methods. The monetary outlay for the little equipment to be described is small compared with its usefulness.



Probably the most important tool of the abrasive equipment is a small grinding and polishing head. A very suitable little polishing and grinding head for use in the small shop is shown in Fig. 251. This can be purchased on the open market for about \$4.00 and considering its importance it is indeed very cheap at this price. For those who wish to construct a grinding head, the

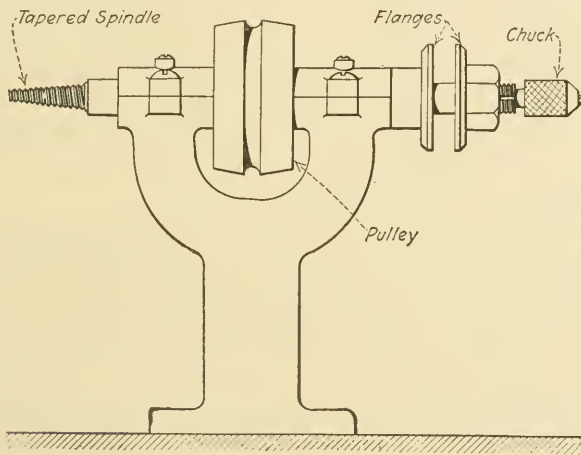

Fig. 251—A small grinding head for shop use. This is a power-driven machine

author has designed and made a very suitable type which is described in Chapter XIII. The little machine shown in Fig. 251 should be belted to a  $1/16$  H.P. motor, and if possible a flat belt should be used. The traction of such a belt is far superior to a round belt and therefore more power is delivered to the machine by the motor. The pulley on the small grinder shown is so designed that either a flat or round belt can be used. The motor used in driving the grinding head should be one capable of revolving at least 2000 R.P.M. If it is impossible to obtain

a motor with this speed, one of a lower speed can be used and a large pulley put upon its shaft. If a motor with a speed of 1000 is obtained, a pulley twice the size of that used on the grinding head should be placed upon the motor shaft, giving a ratio of 2:1 so that the speed of the grinding head will be about 2000 R.P.M. This speed is by no means necessary for all work but it will be found that the higher the speed is for buffing operations the better the result will be and a speed of 5000 R.P.M. would not be too great. However, unless some means of adjusting the speed is used, this speed could not be obtained owing to the fact that it is too high to use for ordinary purposes and therefore could not be used for all operations performed on the grinding head.

Small grinding heads of the type shown generally have a shaft about  $\frac{3}{8}$  in. in diameter and therefore the grinding wheel which is to be used upon it must have an arbor made for this size shaft. Suitable small wheels for use on such grinders are made by all abrasive manufacturers and it will not be found difficult to purchase them in various grits and grades with the proper sized arbor. If the arbor is not of the proper size, but too large, it will be found extremely difficult to mount the wheel so that it will revolve concentrically with the shaft. A large arbor can be remedied by turning up a small brass bushing on the lathe to fit in the arbor. The bushing can then be drilled out so that it will fit over the shaft nicely. In making a bushing for a grinding wheel it should have a loose fit in the center of the wheel and it should not be forced when put in place. If it is forced, the wheel is very apt to break in two.

Before going into more detail concerning suitable abrasive wheels to be used on the little grinder described,

it will be well to say a few words concerning the physical characteristics of grinding wheels in general so that the mechanic may be able to choose his wheels intelligently and to know the best wheel for different classes of work. The little wheels used on this grinder are cheap and therefore the average mechanic can well afford to have a small assortment on hand.

Wheels are manufactured with various grits, grades and bonds. The "grit" of a wheel is the size of the abrasive particles which go to make it up. If a wheel is 80 grit, 80 signifies that the abrasive particles which make up the wheel are just able to pass through a screen having 80 meshes to the square inch. A wheel in 20 grit, for instance, would be a very coarse wheel and a wheel of 200 grit would be very fine.

The "bond" of a wheel is the substance that binds the abrasive particles into a solid mass. Various bonding substances are used. Certain fusible vitrifying clays are used. These clays are mixed with abrasive particles, pressed into shape under hydraulic pressure and placed in a vitrifying kiln where fusion of the clays takes place, resulting in a hard matrix which holds the abrasive particles together. Vitrified wheels are widely used for various purposes. Silicate wheels are bonded by silicate of soda which has a viscid, tacky nature and which, when dehydrated, forms a solid mass. The abrasive particles are mixed with the silicate of soda and after being shaped are placed in a baking oven where dehydration takes place. Other bonds are used such as shellac and rubber, but their use in the industrial field is limited to very special processes and for this reason they will not be considered.

The bond in an abrasive wheel is an extremely im-

portant consideration and its nature either contributes or detracts from the efficiency of the wheel. If the bond is too hard for the work that the wheel is doing the abrasive particles cannot break away from their setting rapidly enough and they therefore remain in place until they become very dull. On the other hand, if the bond is too soft the particles lose their connection with the wheel and fall off before their sharpness has disappeared. In the first case, great friction will be developed and the cutting efficiency of the wheel will be considerably reduced. In the second case, the wheel will cut freely and easily but will wear away very rapidly.

For general shop use the writer recommends the following wheels and the mechanic will do well to purchase them.

Carborundum, vitrified, grade I, grit 50.

Aloxite, vitrified, grade D, grit 90.

Aloxite, vitrified, grade J, grit 120.

Carborundum, vitrified, grade O-P, grit 80.

Aloxite, vitrified, grade MO, grit 40.

It must be understood that Carborundum and Crystallon are chemically the same substance, but with a different trade name. They are both carbide of silicon corresponding to the chemical formula  $\text{SiC}$ .

Very small wheels (from  $\frac{1}{2}$  to  $1\frac{1}{2}$  inches in diameter) of very fine grit are often found very useful. These are commonly known as jeweler's wheels and they leave a finely finished surface upon the article being ground. Owing to their fine grit, however, very little metal can be removed unless a great amount of time is spent in grinding, and they are especially adaptable for real delicate work. These small wheels are manufactured with very small arbors and therefore it is impossible to mount

them upon the grinding head in the usual manner. If the grinding head is provided with a little chuck on its spindle, it is possible to use the little kink illustrated at Fig. 252. A machine screw is placed in the arbor of the wheel and the wheel is clamped to it by a nut which holds the wheel between it and the head of the screw. The protruding end of the screw is then placed in the chuck of the grinding head.

It is possible to obtain wheels with different-shaped faces. By the face of the wheel is meant the periphery.

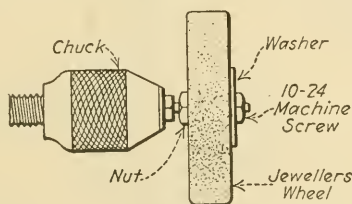

Fig. 252—Mounting a very small grinding wheel in a small drill chuck

A  $\frac{1}{2}$ -in. face would mean a wheel  $\frac{1}{2}$  in. wide. Wheels are made with flat, round and sharp or beveled faces. Many times the wheels with odd-shaped faces are useful in certain work. For instance, if it is desired to grind a groove out the round-faced wheel can be successfully used.

It will be found that the little grinder illustrated in Fig. 251 will not be able to stand up for heavy grinding such as finishing heavy, rough castings, etc. However, the grinder described in Chapter XIII will be found suitable for heavy work. In the event the mechanic does not wish to make the grinder described in Chapter XIII, he may purchase a small hand grinder similar to that depicted at Fig. 253 for \$4 or \$5. Such machines are commonly known as bench grinders and they are provided

with a small clamp by means of which they are held to the bench. The disadvantage of using such a grinder is that it is necessary to use one hand to drive the machine and one to hold the work. In most cases it is quite neces-

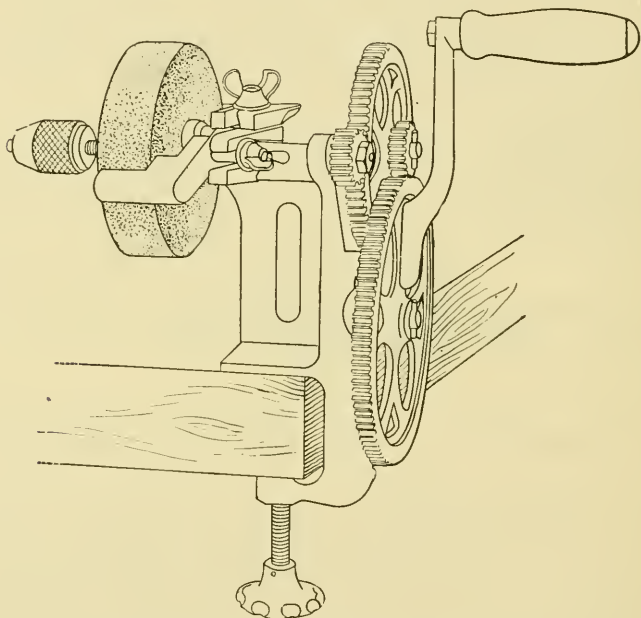

Fig. 253—A hand-driven bench grinder

sary to hold the work with both hands in order to guide it properly. Unless someone turns the wheel it is quite impossible to grind properly by its use. The ingenious worker, however, could easily work up a method of driving the wheel by power. It would also be necessary to take off the handle and replace it with a pulley. The motor used to drive the machine should be of the low-speed variety and it will be necessary to use a very small pulley upon its shaft and a large pulley upon the grinder. This is necessary, owing to the fact that these grinders

are geared up very high so that the wheel will reach a high speed when turned by hand. Wheels used on bench grinders are generally about 5 in. to 8 in. in diameter with a 1-in. face. Of course, it is possible to use different-sized wheels on the grinder if they have the proper-sized arbor.

Mechanics who have large, power-driven, grinding heads in their shop should take great care in mounting the wheels upon the spindle. At high speed, grinding wheels often burst without warning and men have often been killed by being struck with a flying fragment. The centrifugal force on the periphery of a grinding wheel when running at high speed is tremendous and when the wheel bursts it causes the fragments to travel at a very great velocity. Wheels should fit freely on the spindle and should never be forced on. The larger wheels often have a lead bushing and if this bushing fits too snugly on the spindle and the bearing of the grinding wheel becomes too hot, the heat will be communicated to the lead bushing and in time the bushing will expand. The coefficient of cubical expansion of lead is somewhat high and therefore its expansion will bring considerable pressure to bear upon the arbor of the wheel. If this pressure becomes great enough the wheel will burst and the pieces fly from the shaft. Before a wheel is mounted on the spindle it should be tapped very lightly with some metallic tool. If it gives a clear, distinct "ring" it can be mounted without fear. However, if it gives a flat note when struck a light blow it should not be mounted upon the grinding head and a careful examination will reveal a crack in it at some point.

As a further assurance against possible breakage, wheels should never be run above their rated surface

velocity. Wheels are manufactured for different surface velocity, high and low, and before they leave the factory they are tested at their operating velocity. Beyond this velocity the manufacturer will not guarantee them and it is not safe to operate them beyond this stated velocity.

After continued use the profile of a grinding wheel becomes irregular. It is restored by a process called dressing. It is impossible to do careful work on a wheel that is badly worn. Manufacturers of abrasive wheels put on the market small wheel dressers which are used in bringing grinding wheels back to a workable condition. These dressers generally consist of several steel wheels with teeth in their periphery which revolve in a suitable cast-iron holder. To use the tool the steel wheels are brought into contact with the face of the revolving grinding wheel and though the wheels are much softer than the abrasive wheels they cause the wheel to wear away very rapidly. A good substitute for such a wheel dresser can be found in a piece of an old broken wheel. When this is brought in contact with the revolving wheel it will turn it down very nicely and the writer has found that this really works more satisfactorily than the more expensive type of wheel dresser. This process is also good for a glazed wheel or a wheel that has become filled up with softer metals.

The lathe can be used as a lapp grinder by mounting a wooden disc (Fig. 254) upon the surface plate. Over this wooden disc a circular piece of abrasive cloth is glued. Abrasive cloth and paper can be obtained in various grades and grits. The mechanic should have some very fine, medium and coarse grit abrasive cloth and paper on hand at all times. Such paper and cloth are



produced in standard sheets, 9 x 11. The circular piece to use on the wooden disc can be cut from such a sheet with a sharp knife by laying the disc upon the sheet and running around the periphery with a knife. A thin application of carpenter's glue can be used to hold the abrasive cloth to the surface of the wooden disc. Paper should not be held by carpenter's glue, owing to the fact that it cannot be easily removed as it does not have the strength of abrasive cloth, and it is assumed that the

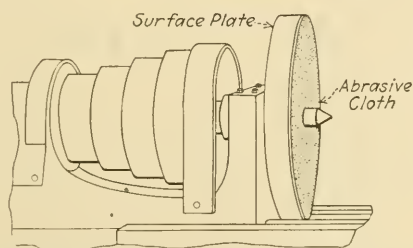

Fig. 254—Abrasive cloth mounted on a lathe face plate

worker does not wish to cut a wooden disc each time he wishes to renew his grinder.

It will be necessary to use a suitable table with such a grinding disc. This table is made to hold the work being ground. It will be an easy matter to design and build a small table which will clamp to the cross slide of the lathe. The table should be perfectly flat and arranged so that it will be at exact right angles to the surface of the disc. In mounting it, it should be placed so that its edge will be at the center of the grinding disc.

Such a little grinding disc has a multitude of purposes and the writer has found it extremely useful in finishing small parts, etc. If it is desired to produce a flat surface on a small casting or piece of stock it can be readily done with this simple little device. When fine paper is

used on the disc it is possible to produce a very accurate surface.

Another very simple little attachment for a grinding

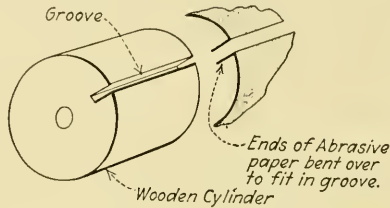

**Fig. 255**—Mounting abrasive paper or cloth on a small wooden cylinder for use in the lathe

head is shown in Fig. 255. This is a small cylinder of wood, on the surfaces of which abrasive cloth or paper is held by cutting a slot lengthwise of the surface of the cylinder, into which the ends of the abrasive cloth or



**Fig. 256**—A simple lapp board

paper are forced. By passing a bolt through the center of this cylinder it may be held in the chuck of the lathe, or, if it is not too long, it can be drilled out to fit the spindle of the grinding head. To give an instance of the use of such a device, the writer once had a dozen carbon brushes which had to be used on a commutator  $2\frac{1}{2}$  in.

in diameter. The brushes had square ends and therefore it was necessary to machine them so that their ends would conform to the shape of the commutator upon which they were to be used. A cylinder  $2\frac{1}{2}$  in. was turned up on the lathe from a good piece of spruce and the abrasive cloth affixed to its surface. A rest or table was then made and the brushes were brought in contact with the abrasive cloth at the exact center of the cylin-

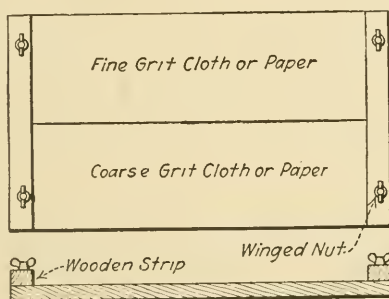

Fig. 257—Details of the lapp board

der. The ends were then concaved so that they fitted the commutator upon which they were to be employed. There are many other uses to which these little cylinders can be put.

What is known as a lapp board is shown in Figs. 256 and 257. This is merely a board upon which two strips of abrasive cloth or paper is held flatly. By means of the wooden strips at the end, which are held in place by winged nuts, the abrasive cloth or paper can be readily put in place or removed. The little board is used in polishing or grinding flat surfaces. If the work is held with the fingers and oscillated rapidly back and forth on the surface of the abrasive cloth with a slight pressure it will be found that very flat surfaces can be produced.

One side of the board should have cloth of a very fine grit and the other side should be of coarser grit.

A variety of abrasive powders and grains should be kept for use. Abrasive grains run in grit from 12 to about 200; 12 being very coarse and 200 quite fine. Grains beyond 150 are called powders and they are generally graded by floating them on water. The writer would advise the mechanic to purchase a few ounces of No. 50, 100 and 150 grains, and what is known as FF powder (Carborundum). The FF powder, which is a very fine flour, can be used for the process of lapping. Lapping is generally used for hardened steel only, but it is a process which can be adapted to other work, especially in the shop of the amateur. In ordinary lapping the lapps are usually made of soft material into which the abrasive particles can readily be pressed. Soft, close-grained cast iron, copper or lead can be used as a lapp, and the surfaces can be charged by rolling the lapp in the particles. For internal lapping the lapp is made cylindrical in shape. It will be assumed that a hardened steel cylinder with an internal bore is to be lapped out exactly 2 in. in diameter and that it is within a few thousandth parts of an inch of this diameter. Owing to the fact that it is made of hardened steel it would be impossible to turn it out on the lathe, and the amount of metal to be removed is so small that it would not be practical to employ an ordinary internal grinder. In this case the lapp would be used and after being charged with abrasive particles of very fine grit it would be inserted in the cylinder and allowed to remain there some time with the lathe revolving at high speed. This is generally done in cases where extreme accuracy is necessary and the amateur will probably never have any work requiring such an operation.

A simple method of lapping is shown in Fig. 258. In place of a metal lapp a wooden one is used and its surface wetted with oil. The abrasive flour is then sprinkled on and the oil causes the particles to adhere to the surface. The wooden piece should be turned for a fairly tight fit in the cylinder. In the operation shown in Fig. 258 the lapp is being used to finish the bore of a small steel engine cylinder. Such a lapp leaves a smooth, glass-like surface.

Felt wheels are very useful in grinding operations. Such wheels can be purchased at polisher's supply houses for a few cents and they are affixed to the grinding head in the same manner as an abrasive wheel. The periphery of the felt wheel is covered with carpenter's glue and it

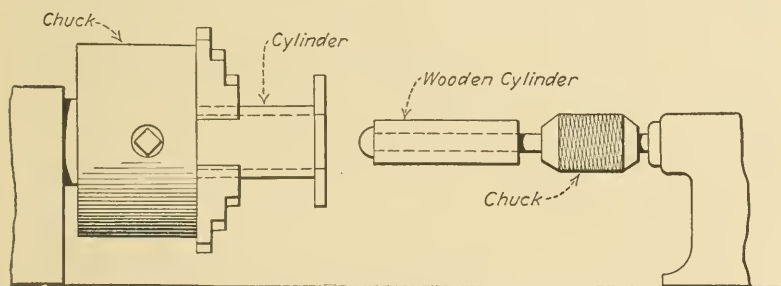

Fig. 258—Lapping on the lathe

is then rolled in the abrasive powder or grains that are to be used upon its surface. After this is done the wheel is set away to dry and when dry it can be used for polishing various metals. The polish left upon the surface of the metal will depend entirely upon the fineness of the grains used.

Buffing is easily accomplished on a grinding head by revolving it at high speed and mounting upon the spindle, what is known as a rag wheel. This is a wheel made up of cotton discs sewed together. When buffing is done

the grinding head should be revolved at its maximum speed. While the rag wheel is at high speed, and before the work is applied to it, a piece of polisher's rouge should be held against it. The work is then brought in contact with the wheel and as much pressure applied as the motor which drives the grinding head will overcome without any serious reduction in speed. The work is rubbed against the surface of the buffing wheel with an upward motion and at regular intervals the rouge should be applied. The grinder shown in Fig. 251 has one end of its spindle tapered and this is done especially for the mounting of rag wheels. The hole in the center of the rag wheel is very small and the taper is inserted in this and the wheel "screwed" tightly in place. Wheels can also be purchased with a larger hole in the center so they can be mounted upon the grinding head in the same manner as an abrasive wheel.

## CHAPTER IX

### Pattern Making

How patterns are used—Making moulds—How casting is accomplished by the use of patterns—Moulding board—Cope—Drag—Use of cope—Use of drag—Procedure in making mould—Tools required in moulding—Tools required in pattern making—Making patterns—Simple patterns—Split patterns—Woods used in making patterns—Shrinkage of metals—Draught—Laminated patterns—Filletts—Method of making filletts—Cored patterns—Core boxes—Making core boxes—Furnace for melting brass and bronze in the home shop—Construction of furnace—Construction of burner—Gasolene tank—Use of furnace.

A COMPLETE treatment of pattern making would require at least a fair sized volume, and the best the author can hope to do in this Chapter is to impart to the reader the general principles of pattern making and the method used in producing simple patterns.

If a piece of metal a certain shape is desired, a wooden pattern is made to this shape and when this reaches the foundry an impression of it is made in sand and into this sand impression the molten metal is poured. After the metal has become cool the casting is lifted out of the sand. Various metals and alloys are used in casting. The common metals used are iron, aluminum, bronze, copper, lead, brass and zinc. Briefly stated, this is the process by which patterns are used in producing metal castings.

Before going farther into the production of wooden patterns, it would be well to give the reader a better idea of how a pattern is used, that is, just how the impression

in the sand is made. Having this in mind the mechanic will be better able to produce patterns which the foundryman will be able to use.

It will be assumed that the pattern of the face plate

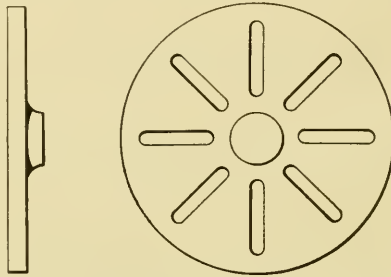

Fig. 259—A lathe face plate to be cast

shown in Fig. 259 is to be cast. The pattern is first placed face down upon what is known as a moulding board. This is shown at Fig. 260. With the pattern in this position, what is known as a drag is placed over it as illustrated in Fig. 261. A drag is nothing more or less than a rectangular wooden frame. With the drag in position, sand is sprinkled over the pattern and the end of

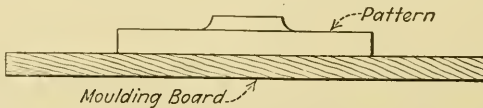

Fig. 260—How the pattern is mounted upon the moulding board

the drag is rammed full of sand to the top. When the sand reaches the top, a straight-edge is used to level it off flush. What is known as a bottoming board is then placed over the top of the drag and the drag with the pattern in place is then turned upside down, leaving the pattern as shown in Fig. 262. The cope, which is another rectangular frame similar to the drag is then placed



over the drag and rammed full of sand. After the cope has been filled and lifted off, the pattern is removed from the sand with a draw pin. In removing the pattern from the sand it is necessary to rap it to prevent the

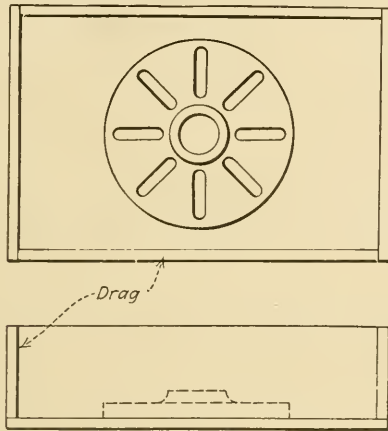

Fig. 261—The drag placed in position

sand from clinging to its surface which would spoil the mould. After the pattern is removed a sprue pin is pressed into the sand to form an opening through which the molten metal runs into the mould. When this is done,

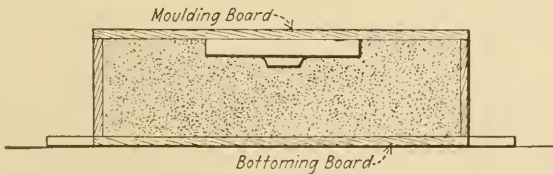

Fig. 262—The filled drag placed on the bottoming board

the cope and drag are placed together and with the addition of a few vent holes, which permit the air to leave as the metal runs in, the apparatus is ready for casting.

The pattern of the face plate is an especially simple

type to cast and it is well to mention here that all patterns are not so simply made or so easy to cast.

The pulley shown in Fig. 263 could not be cast in the same manner as the face plate. It will be seen that this pulley has a crown face with opposite tapers and therefore if an impression was made in the sand of the pulley

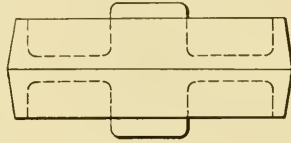

Fig. 263—An example of a split pattern

it would be impossible to remove the pattern without destroying the mould. If, however, the pattern is split in the middle it is possible to make an impression of each half and then bring the moulds together to make the casting. Such a pattern is known as a split pattern and they are commonly used. The way in which a split pattern

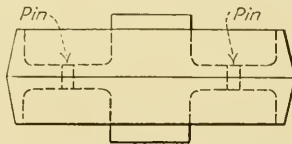

Fig. 264—How a split pattern is held together by pins

is held together is shown in Fig. 264. Holes are made in one half and small brass pins in the other half lock into these holes. Such a pattern is cast in the following way. The half without the pins is laid face down upon the moulding board. The drag is put in place and the sand packed around and leveled off as mentioned in connection with the casting of the face plate. This done, the drag is turned up and the moulding board lifted off, leav-

ing the pulley pattern facing upward. The cope is then placed over the drag and the other half of the pulley is placed on the half which is imbedded in the sand contained in the drag. When this is done, sand is packed into the cope and leveled off at the top. The cope and drag are then parted and the two halves of the pulley removed. The cope and drag are then put together again in the same position, which brings the two halves of the mould into register.

The tools required for pattern making are very simple and it will be found that the following list will include all the necessary equipment and materials:

Sharp knife.

Block plane.

Hack saw.

Ruler.

Dividers.

Calipers.

Chisels.

Gouges.

Square and bevelled protractors.

Sand paper.

Shellac.

Several different kinds of wood can be used in making patterns. These include mahogany, white pine, white wood and cherry. White pine is a delightful wood to work with and it seems to have first choice among most amateur pattern makers. If a pattern is to be used considerably and many castings have to be made from it, it might be well to make it of mahogany as this wood will stand more abuse than white pine. Brass is also used at times to make patterns and a brass pattern will last indefinitely. Owing to the difficulty of producing

good brass patterns few amateurs care to attempt making them.

When the metal in a mould cools it shrinks considerably, and therefore, in order to compensate for this shrinkage it is necessary to make patterns a trifle larger than the finished casting is to be. The amount of shrinkage depends entirely upon the kind of metal being cast. The following table can be referred to when patterns are being made:

|                 |                                    |
|-----------------|------------------------------------|
| Brass .....     | 3/16 inches shrinkage to the foot. |
| Zinc .....      | 3/16 " " " " "                     |
| Copper .....    | 7/32 " " " " "                     |
| Cast Iron ..... | 1/8 " " " " "                      |

If a casting of copper 2 ft. long was to be made it would be necessary to make the pattern 2 ft. 7/16 in. long in order to compensate for shrinkage.

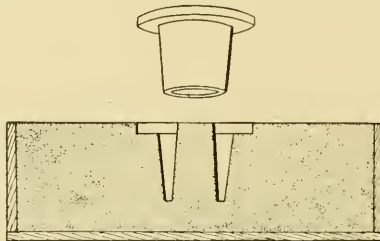

Fig. 265—Illustrating the meaning of draught

Most patterns must be provided with what is known as a draught. The draught of a pattern is really a very slight taper so that it can be pulled from the sand without breaking the mould. This will be made clear by referring to Fig. 265, which shows a pattern for a cylinder being pulled from the sand. The draught shown in the drawing is greatly exaggerated.

It is well to make most patterns with laminations if a great number of castings are to be made. Three equal thicknesses of wood are generally used to form the laminations and they are held together by heated or prepared glue. For simple patterns from which but few castings are to be made, laminations need not be resorted to as it would be a waste of time.

In making patterns the mechanic should always use his square and every piece cut should be squared up and planed perfectly true. It will be found that the lathe will come in very useful in producing circular pieces for use with patterns. Tiny brads are used many times in

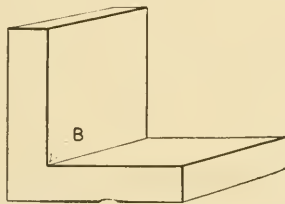

Fig. 266—A piece of the shape shown must be provided with fillets before it can be cast

holding the parts of a pattern together and their heads should be driven under the surface with a nail set and carefully covered with putty. After a pattern has been produced to shape it should be given a careful sandpapering with No. 00 paper. After this is done, it is given a coat of shellac and set away to dry. When dry, this initial coat of shellac is sandpapered off and another coat is applied. The first coat of shellac is used to fill up the grain of the wood and the second coat will leave the pattern with a high glossy finish. Such a finish is necessary so that in pulling the pattern from the sand the mould will not be destroyed by sand adhering to it.

Sharp corners should never be made on patterns as

they will always cause weak spots in the casting, owing to the strains which are set up in the metal when it cools. These strains often result in fractures before the casting is taken from the sand. If the piece shown in Fig. 266 was to be cast, all the corners of the wood should be slightly rounded and the corner "B" should be provided with a fillet. The fillet can be made of a little strip of wood tacked or glued into position. The fillet should have a radius in proportion to the thickness of the pattern and for very small patterns the radius need not be over  $\frac{1}{8}$  in. Owing to the difficulty of producing a curved, thin strip of wood as small as this, it is necessary to resort to some substitute and hot wax is generally the substance used. Warm beeswax can be nicely worked into the corner to serve as a fillet, by the aid of a little round-nosed tool. When the beeswax is pressed in place and covered

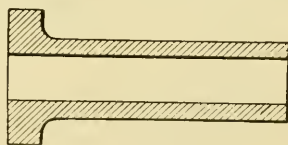

Fig. 267—Cross-section of a cored casting

with a few coats of shellac there is no danger of it being removed with ordinary use of the pattern.

Cored patterns and core boxes will now be considered. In order to explain the use of core boxes in producing cored patterns, it will be assumed that a casting similar to that shown in Fig. 267 is to be made. The reader will realize that a pattern made to the shape of the cylinder shown would be useless in forming a mould, owing to the fact that the hole in the center of it would interfere with drawing it from the sand. The sand when packed in the center of the pattern would be pulled out with the pat-

tern and a solid casting without a hole would result. A properly shaped pattern to produce the cylinder shown in Fig. 267 appears in Fig. 268. The projections at the

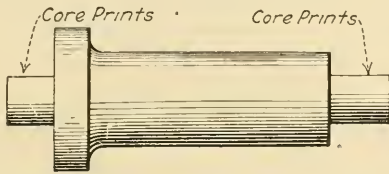

Fig. 268—Example of a cored pattern, showing the core prints at the ends

end are known as core prints, and with such a pattern it is necessary to use a core box. This core box is nothing more or less than two blocks of wood, which, when placed together, will have a hole in their center a trifle smaller than the core prints on the pattern. A core box to use with the cylinder pattern is shown in Fig. 269.

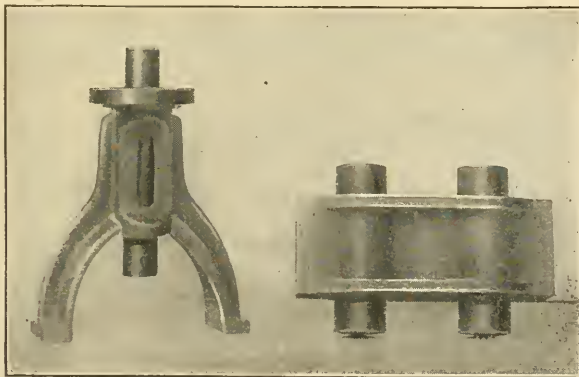

Fig. 269—A core box for use with the pattern shown in Fig. 268

One half of the core box is provided with projecting brads and the opposite half has small holes drilled in it to receive these brads, and the two halves are held together in this way. When placed together, the foundry-

man presses a mixture of moulding sand and molasses and other ingredients down into the hole, and when the

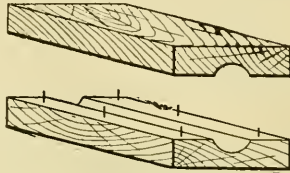

Fig. 269A—A core box

hole is pressed full the core box is split apart and the sand lifted out.

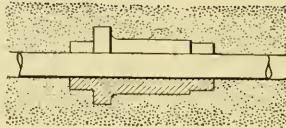

Fig. 270—The print left by a cored pattern

By carefully studying Fig. 270 and 271, the use of a core box and core prints on the pattern will be under-



Fig. 271A—Several ordinary patterns without core prints

stood. The pattern with the core prints leaves an imprint in the sand similar to that shown at Fig. 270, and



it will also be understood that the impression left in the sand by the core prints is superfluous. Into these prints the core itself, which is made of sand moulded in the core box, is placed. The cope and drag are then placed together and the casting is ready to be poured. A study of Fig. 271 will show that the molten metal will run around the sand core and cool in this way, leaving the sand imbedded in the center of the casting. Core prints generally project from the pattern from  $\frac{1}{2}$  in. to 1 in. for small work. The projection usually depends upon the size of the pattern. It will be seen that the core print of the pattern must be a trifle larger in diameter than

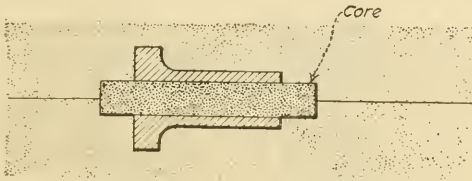

Fig. 271—A print left by a cored pattern with the core in place ready for casting

the sand core, owing to the fact that the core must fit into the core print without disturbing the mould. The core prints on a pattern are always painted black to distinguish them from the rest of the pattern and so that the foundryman will know that they are not to be cast whole.

Core prints are not only used to produce holes in a casting in the manner described. Reference to Fig. 272 will make clear another use of core prints in producing a casting of an electric meter case. A casting which is to be hollowed out in this way must be provided with core prints and a proper core box.

Large foundries are generally equipped with means

for making cores of standard sizes, such as  $\frac{1}{4}$ ,  $\frac{3}{8}$ ,  $\frac{1}{2}$ ,  $\frac{3}{4}$ , 1,  $1\frac{1}{4}$ ,  $1\frac{1}{2}$ , etc. The amateur is advised, however, to make his own core prints as all foundries do not have such equipment on hand.

If a small steam engine cylinder is to be cast with a cored hole the hole should be at least  $\frac{1}{8}$  in. to  $\frac{1}{16}$  in. smaller in diameter than the finished bore of the cylinder. This is to allow for machining. In a small cylinder,  $\frac{1}{16}$  in. is sufficient allowance and a rose reamer will nicely remove this amount of metal with one cut. In the case of large cored holes more allowance should be made for machining.

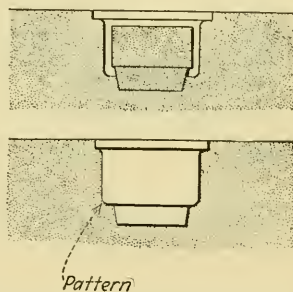

Fig. 272—Method of making an impression for a meter case

Before sending patterns to the foundry, the mechanic should place small paper "stickers" upon them and the number of castings to be made from each set is marked upon this "sticker." For instance, if a set of patterns were cut for a model twin-cylinder steam engine the pattern for the steam chest would be marked "2" and this would show the foundryman that two castings of this particular piece were necessary for each set of castings for the model engine. Other parts used in duplicate should be marked the same way. It is well to put the stickers on before the coating of shellac is put in place.

When castings of iron are received from the foundry they are oftentimes encrusted with an extremely hard "skin." This hard skin results from the cooling of the iron, and it is often so hard that it will turn the point of the lathe tool over when being machined. If the tool can be forced under the surface of this skin into the softer part of the metal, it will be found that this skin can be cut away without any trouble and without damage to the point of the tool. To assist the tool in getting under this hard skin, a little spot can be ground in the casting and when the point of the tool reaches this spot it will dig into the surface. Another method is to immerse the casting in a pickle composed of one part of sulphuric acid and four parts of water. This softens the hard surface of the metal and restores it to its natural degree of hardness.

With a suitable furnace in which to melt bronze, copper, brass and lead, the mechanic will be in a position to cast many of his own simple little patterns at home without resorting to the foundry, as most foundries, especially the larger ones, do not wish to be bothered with small orders for small castings. The materials needed, aside from the furnace, are very inexpensive.

The moulding sand can be obtained from the local foundry for a few cents per pound, and the copes, drags and bottoming boards are easily produced.

The little home furnace for melting bronze, brass, etc., described in the following paragraphs, is easily made, and, having a capacity of several pounds of metal, it will be found sufficient for all ordinary sized castings which enter into the construction of models and small parts.

As explained in the preface, the author is indebted to Mr. R. W. Wagner for the design and description of this

furnace and it will probably be best to use Mr. Wagner's own words:

“The melting of the metal is undoubtedly the most difficult problem to be solved in connection with our foundry project. Possibly some have considered it either too difficult or too impractical to be attempted in the home shop. However, a home-made furnace may be constructed that will successfully melt brass and bronze.

Three different furnaces were built and tried out. The first one, A, Fig. 273, is rather conventional in design

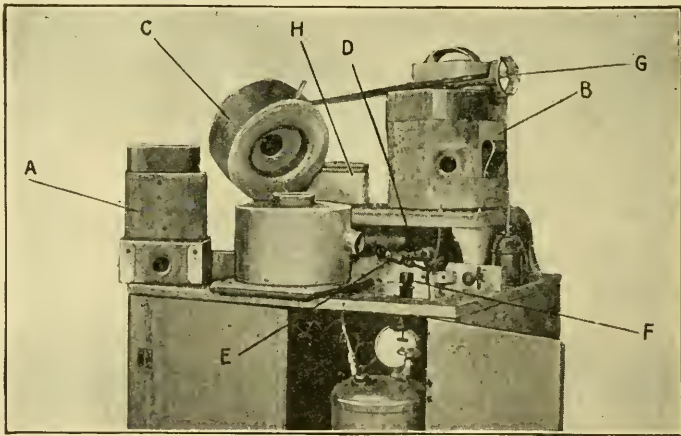

Fig. 273—A small brass and bronze smelting furnace for use in the small shop

and was satisfactory except that removing the crucible was rather inconvenient. The second one, B, was similar to the first except that it was larger, and was built of fine brick. In both of these furnaces the crucible rested on supports which projected from the sides of the furnace inward. The flame, entering the opening in the side, passed underneath and up around the crucible, escaping at the top.

The last one constructed, and the one which is undoubtedly the best, is shown at C, Fig. 273. It is built in two parts, a cover, hinged to open up, and a base. It is shown with the cover propped open and the crucible in place. In this furnace, the crucible rests on the flat bottom of a circular chamber which the flame enters at a tangent, whirling about and up around the crucible, leaving the furnace through the hopper-shaped opening

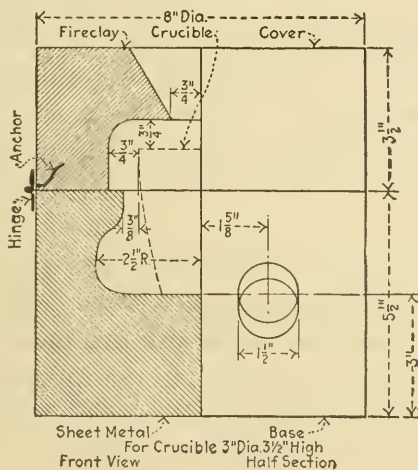

Fig. 274—Details of the furnace illustrated in Fig. 273

in the cover. Fig. 274 gives details needed in constructing the furnace. The axis of this tube at which the flame enters makes an angle of 16 degrees with the horizontal, in this particular case. Some builders may prefer to make the axis horizontal. The tube should be short in any case.

Gasoline is used for fuel. It is fed from a tank at a pressure of 30 lbs. In passing through the nipple D, Fig. 273, it is vaporized and issues in a jet from the needle valve, E, Fig. 273. The nipple is kept hot by the

pilot burner F. The needle valve was taken from an old blow torch and the pilot burner from an old gasoline mantle lamp. The jet of gasoline vapor is directed into the opening in the side of the furnace, and, as it rushes in, carries along the right amount of air for proper combustion. After the pilot has been started and has heated the nipple sufficiently to vaporize the gasoline, the furnace flame may be started by opening the needle valve and holding a lighted alcohol torch beneath the issuing jet of vapor until the flame will maintain itself when the torch is removed. In starting, it is well to lift the cover of the furnace slightly to allow the gases good circulation. When the furnace and crucible are red hot, the cover should be lowered. It is essential to have the needle valve the proper distance from the opening in the furnace. This can be determined by trial. With this furnace the best distance seemed to be  $2\frac{1}{2}$  in.

Perhaps the best metals to use are brass and bronze. A good way to secure brass is in the form of junk steam fittings. The experimenter will no doubt be tempted to alloy the brass with aluminum. This is to be advised against as trouble will be had with the formation of dross.

## CHAPTER X

### Hardening and Tempering Steel

How steel is hardened—Essential requirements for proper hardening—Tempering—Necessary temperature—Apparatus required—Decalescence point—Recalescence point—Tempering steel—Different temperatures—Quenching—Quenching baths—Case hardening—Apparatus for case hardening—Temperature for case hardening—Materials required for case hardening—Home-made hardening furnace—Construction of home-made hardening furnace.

It is necessary for the amateur mechanic to know how to treat steel so that he may harden his own lathe tools and machine parts. It must be confessed that the hardening of steel is an exacting process that few men are proficient in, yet, with a few simple rules-of-thumb, the mechanic may do his own work in a satisfactory manner that will at least be suitable for the home shop.

Steel is hardened as the result of an internal change in the structure which takes place when the steel is heated properly to a correct temperature. The change which takes place in the steel depends entirely upon the amount of carbon present. In ordinary carbon steel the percentage of carbon is between .2 per cent and 2 per cent. Ordinary carbon steels begin to soften at about 390 degrees Fahr. At 400 degrees F., practically all of the hardness in the steel has disappeared.

Several requirements are essential to good hardening. Small projections or ends should not be heated more

rapidly than the body of the piece of which they form a part. In other words, all parts of a piece of steel should be heated at the same rate and they should all be heated to the same temperature. It is only possible to do this by heating the steel slowly. A uniform heat carefully regulated will produce the best results. Steel that is not heated uniformly is apt to be destroyed by irregular grain or internal strains which produce surface cracks. As before stated, every steel has its critical temperature, above which it should not be heated. When heated above this point its grain becomes coarse and its strength diminishes appreciably. The higher percentage of carbon present in steel, the lower will be the temperature required to bring about the internal change which hardens the steel. In simple language it may be said that the critical temperature points of a high carbon steel are lower than those of a low carbon steel. In common carbon steels there are two critical temperatures. One is called the decalescence point and the other the recalescence point. It has only been during the past few years that attention has been paid to the decalescence and recalescence points in steel, and through new knowledge along this line the science of hardening steel has been greatly improved.

To facilitate the explanation of the decalescence and recalescence points, reference should be made to Fig. 275. It will be seen that as the temperature of the steel rises a point is reached in the neighborhood of 735 degrees, where the temperature of the steel actually falls even though the source of heat is not diminished in the least. The metal continues to absorb heat without appreciably rising in temperature. This is called the decalescence point, and it is believed by scientists that this is the



point where an actual change in the physical and chemical structure of the steel is brought about, and that the heat applied to the steel is used in bringing about this change. When the decalescence point of steel has been reached it should be immersed in the quenching bath. It is understood, of course, that the average home work-

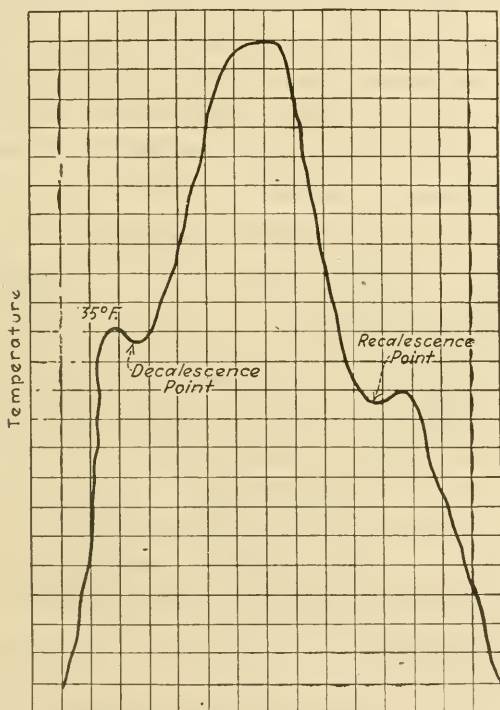

Fig. 275—Chart illustrating the recalescence and decalescence point of steel

shop is not equipped with the necessary apparatus to determine the decalescence point of steel and this information is merely set forth to give the reader a better understanding of the general nature of steel. An expensive electrical pyrometer is necessary to determine the

decalescence and recalescence points of steel. In practice it has been found advisable to heat the steel a few degrees above the decalescence point so that it will not cool too much before it reaches the quenching bath. If the steel, after reaching the decalescence point, was allowed to cool, it would reach a certain point where the temperature would rise as shown in Fig. 275. This point is called the recalescence point and is generally a few degrees below the decalescence point. The recalescence point is that at which the steel changes to its original condition unless it has been quenched before it reaches this point. The heat absorbed at the decalescence point in bringing about the necessary physical and chemical change in the steel is given up again at the recalescence point where it goes back to its original nature.

In tempering steel the mechanic must take advantage of a few simple rules-of-thumb, owing to a lack of the necessary scientific equipment which forms a part of the professional tempering establishment. As before stated, to harden carbon steel it is first necessary to heat it to a certain temperature and suddenly quench it in cold water. After quenching, the steel will be in a very hard and brittle condition and it is brought down to the proper degree of hardness by a process known as tempering. Immediately after quenching the steel would be too brittle for use and would probably break if used. To harden a lathe tool the point should be heated red and when it reaches this point it should be suddenly immersed in a bath of cold water. The opposite end of the tool should not be allowed to reach a point of redness, as this part of the tool should be more soft and tough than the cutting edge so that it will not break off in the tool post. The mechanic will find that the hardening of lathe tools

can be accomplished with a large gasoline torch, or, better still, a small furnace made of bricks and heated with a gasoline torch. Such a furnace is shown at Fig. 276. If the reader builds a small smelting furnace such as that described in Chapter IX it will serve both purposes, that of melting bronze and that of hardening steel.

The quenching or cooling of a piece of hardened steel is a very important part of the process. It is by this operation that the structural change takes place in the steel and the decalescence point is, we may say, "trapped." The heated piece should be cooled uniformly

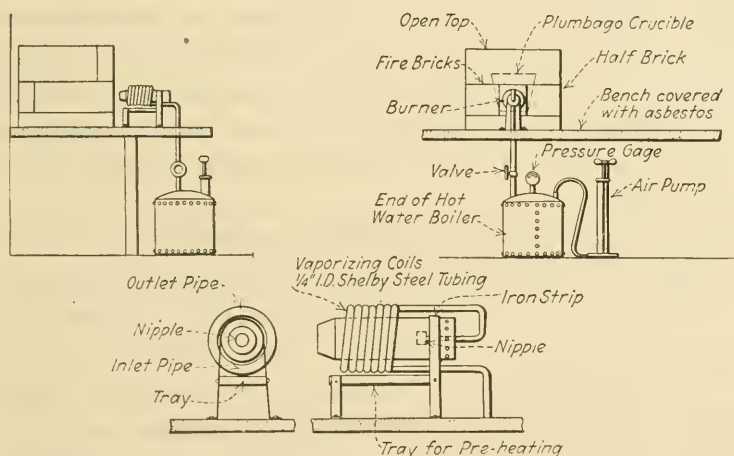

Fig. 276—Details of a home-made tempering outfit for steel

and as instantaneous as possible. To do this the bath should be amply large in order to dissipate the heat rapidly. Too small a bath will cause the steel to cool slowly and when cooled in this way it is sure to be defective. Instead of having a basin of still water for the bath it is advisable to have a large basin with running water.

If a little salt is added to the quenching bath it will be found that a greater hardness is produced at the same

temperature. This appears to be due to a difference of the heat-dissipating power of the brine and pure water. In fact, the difference is so great that if a small piece of steel is suddenly immersed in a brine solution it will crack. Oil is sometimes used as a cooling bath, but the home mechanic is advised to use pure water, as much more experience is necessary to get proper results with an oil or brine solution.

If the home mechanic wishes to be sure that his steel is above the decalescence point before it is immersed in the quenching bath, he can take advantage of the fact that steel heated to a temperature above the decalescence point is non-magnetic. At bright red steel has no appreciable magnetic properties, that is, it shows no attraction for a magnet. At cherry red it regains its magnetic properties, but at this temperature it is below the decalescence point.

From the foregoing it will be seen that an ordinary horseshoe magnet can be used to determine the proper temperature to harden a piece of steel and to make sure that it is well above the decalescence point. When the steel is brought out and the magnetic test made, it should again be placed in the furnace for a minute or two to make sure that it has regained the heat that it lost while the magnetic test was being made. It may also be possible to make a magnetic test by dropping the magnet into the top of the furnace by a wire.

Having considered the process of the hardening of steel, attention will now be diverted to the process of tempering. When a piece of steel is hardened, its hardness can be lowered to most any degree. To do this the steel is heated to various temperatures, the temperature depending upon the degree of hardness desired. The

color test is sufficiently accurate for all ordinary purposes. When heated, the tool takes on colors which extend from a pale straw through dark straw to brown yellow, yellow purple, dark purple and dark blue to blue. The steel should be heated away from the cutting edge, which is usually the less massive end, so that the back or non-cutting portion of the tool will be softer and tougher. Owing to the impossibility of preventing the back edge of the tool from heating in the tempering furnace and becoming as hard as the cutting edge of the tool during the process of hardening, its proper condition must be brought about through tempering. When the steel being tempered reaches its proper point (determined by color), it should be immersed in the quenching bath. To better judge the color, the tool should be brightened with emery cloth at the working point.

The following table will guide mechanics in producing the proper degree of hardness in tools of various natures.

Dark blue—springs, screwdrivers, wood chisels.

Dark purple—chipping chisels.

Purple brown—turning tools for brass, drills, centering punches and lathe centers.

Brown yellow—reamers, turning tools, punches, drills and dies.

Dark straw—taps, dies, drills, turning tools.

Medium straw—shaper, and planer tools, milling cutters.

Light straw—scrapers for brass.

On the market at the present time there are steels known as "high speed" variety. These are generally alloy steels and instructions for hardening are generally furnished by the makers. Such steels are usually known as self or air-hardening steels, owing to the fact that it is

not necessary to quench them after they are heated to the proper point.

Case hardening is a process of producing a hard external skin or case about the piece of steel, leaving the interior soft and in its original condition. Case hardening is a very important process and it is generally resorted to in producing machine parts which are to resist wear. It is also used in producing certain tools.

To produce a hard crust on a piece of steel it is necessary to heat it continuously for several hours at a certain temperature and in contact with some carbonaceous material. The steel to be case hardened is packed in the carbonaceous substance which generally consists of charred leather, granulated rawbone, bone black, prussiate of potash (potassium ferrocyanide).

The process of bringing the carbonaceous matter to combine with the iron or steel under the influence of a high temperature is called carburising. The surface of the iron or steel under treatment suffers a structural change by the impregnation of carbon. This process is continued at a specific temperature and length of time until the "case" has attained maximum hardness and depth. If the process is continued long enough the penetration of the carbonaceous matter will go to a considerable depth and as a result, produce a thick "case." If it is heated but a short time the "case" will be very thin. The exact length of time for a case of certain thickness must be learned from practical experience alone, as much depends upon the class and size of the article undergoing impregnation. The heating process extends from 3 hours as a minimum to 7 or 8 hours as a maximum. The temperature must be kept within certain limits, owing to the fact that the carbon will not impregnate the steel prop-

erly if the temperature is too high. As a general rule the article undergoing the process should be raised to a temperature of 900 degrees C. and allowed to remain at this temperature the proper length of time, which will depend upon the depth of the case required. The little furnace described in Chapter IX can also be used in case-hardening small parts and by this time it is hoped that the reader will realize the great utility of such a small gas-heated furnace in his shop.

Articles for case hardening should be packed in plain wrought-iron boxes with the carburising material. The box should be of sufficient size so that the article to be case hardened will be at least  $1\frac{1}{2}$  inches from the sides and ends of the box. A cover must be made for the box and when this is put in place all the crevices should be sealed up carefully with fire clay or ganister to prevent the possible escape of all the carbon-bearing gases. The lid of the box can be fastened down with wrought-iron straps so arranged that they can be quickly removed when the box is withdrawn from the furnace. Upon withdrawing the box from the furnace, the cover is immediately removed and the article or articles are plunged into a bath of cold water, allowing them to come in contact with the atmosphere as little as possible. In fact, it is advisable in certain work to plunge the whole box into the cold-water bath.

If a very thin casing of hardened steel is desired, the process described above is not necessary. The article to be hardened can be heated to a bright red, withdrawn from the source of heat and covered with carbonaceous material. It is allowed to "soak" in this for from 1 to 5 minutes. After this process, the part is again heated to bright red and plunged into running water. This

method of hardening produces a skin of hardened steel about 1/100th of an inch thick. This very thin case, however, will resist a tremendous amount of wear.

Owing to the difficulty of obtaining carbonaceous materials referred to in previous portions of this treatment, the home mechanic will find a good substitute by mixing 9 parts of wood charcoal with one part of salt.

Another method of producing a very thin case is shown at Fig. 277. This is practical only with small pieces. The article to be case hardened is packed in carbona-

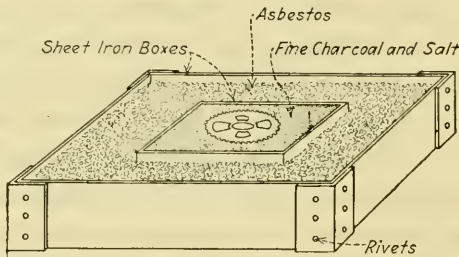

**Fig. 277—A small gear in place for case hardening**

ceous material as shown, and the flame of the torch allowed to impinge upon its surface. After about twenty minutes, the article is turned over so that the opposite side will come in contact with the carbonaceous material.



## CHAPTER XI

### Soldering and Brazing

Theory of soldering—Preparation of surfaces before applying solder—Fluxes—Fluxes for various metals—Making flux—Solders—Composition of solders—Solders with various melting points—Soldering coppers—Heating soldering coppers—Blow torches—Operation of blow torches—Use of Bunsen burner in soldering—Silver soldering—Silver soldering fluxes—Silver soldering apparatus—Application of silver solder—Silver soldering various metals—Brazing—Brazing various metals.

It is difficult to learn the process of soft soldering from printed instructions, but, by the aid of the data given in this Chapter and with a little experience, amateur mechanics should have little trouble producing presentable work.

The most important part of soft soldering is that of properly preparing the metallic surfaces which are to be joined. It is extremely aggravating to have the solder roll around the surfaces of the metal in small balls without adhering. Such a condition is always caused by dirt or by heating the metal surfaces to too great a temperature, which forms a thin film of oxide, preventing the solder from adhering. Any metallic surfaces contaminated with grease or other foreign matter cannot be soldered successfully no matter how cleverly the soldering copper is manipulated. The surfaces to be joined should first be thoroughly cleaned with a scraper or emery cloth. A very useful little scraper for use in soldering

is illustrated in Fig. 278. The triangular portion of the tool should be well hardened and provided with sharp edges. The use of the tool is evident. After a mechanical surface has been properly prepared to receive solder, it should not be handled with the fingers as a certain amount of greasy matter will be deposited upon the surfaces and this will seriously interfere with the work. Although the metallic surfaces should be cleaned until they are bright, it is not necessary to scrape excessively until a noticeable impression is formed in the metal.

Soldering coppers are made in various sizes and shapes. A few of the common shapes are shown in Fig. 279. A very small copper and a medium-sized one will

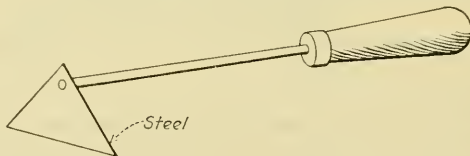

Fig. 278—A hand scraper used in preparing surfaces to receive solder

meet the needs of the average shop. The larger a soldering copper is, the longer it will hold its heat and the more soldering can be done with it before reheating becomes necessary. The disadvantage of a very large copper is the fact that it is clumsy to handle when small pieces are being soldered.

Before a soldering copper can be used, its tip must be properly "tinned." If the point of the copper is not "tinned" the solder melted by it will adhere and difficulty will be experienced in producing a joint. Therefore, the tip of the soldering copper is covered with solder, or, according to the tinsmith's parlance it is "tinned."

To tin a soldering copper, a soft yellow brick should be procured and hollowed out in the center as shown in Fig. 280. Into the cavity produced, a little molten resin is placed together with a pellet of molten solder. The

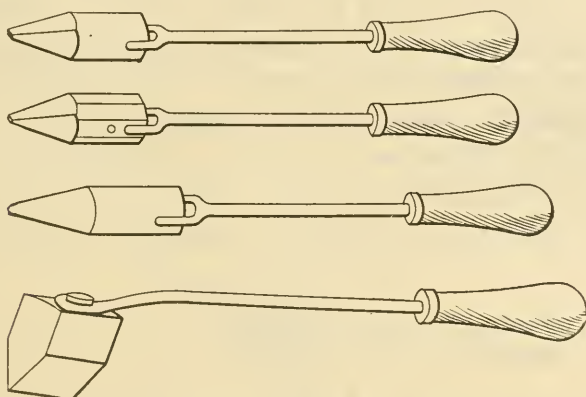

Fig. 279—Different types of soldering coppers used for different purposes

solder will, of course, run separate from the resin. The tip of the soldering copper is carefully brightened up with a smooth file, after which it is heated in a gas or bunsen flame. The point is then placed in the cavity and

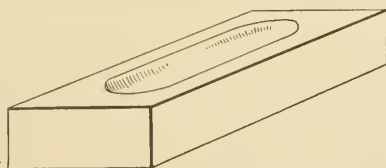

Fig. 280—A tinning brick

held there until the solder melts, after which the tip of the copper is rubbed back and forth in the cavity. During this rubbing it is turned over several times. When the tip of the copper is taken from under the surface of the molten resin and solder it will be found that a quan-

tity of solder adhered to the copper, leaving it in a bright condition. The solder distributes itself over the surface in a thin film. The copper should be kept in this condition at all times and when the tinned surfaces become dull the copper should be heated and the process described above repeated. When the copper has once been tinned the tinning process requires but a minute or two.

A soldering copper must be heated properly. The point of the copper, or the tinned portion, should never be placed directly in the flame. The flame must be applied to the back of the iron as shown in Fig. 281, and

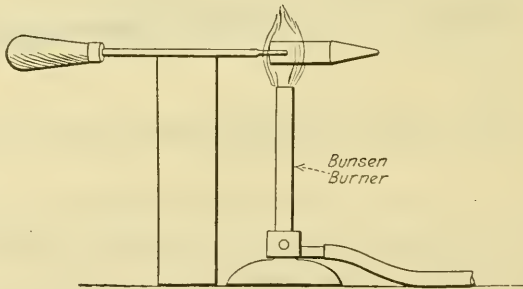

Fig. 281—How a soldering copper is heated with a Bunsen burner

heated in this way the tip of the copper will be raised to practically the same temperature as the back of the copper, owing to the high thermal conductivity of the metal. It is also possible to overheat a copper and although this causes the solder to flow easily it makes the soldering operation much more difficult. A soldering copper at the right temperature should be just hot enough to cause the solder to melt and flow after it has been in contact with it for a few seconds. Instantaneous melting of the solder upon contact with the soldering copper signifies that the copper is too hot. Overheating not only makes the

process of soldering more difficult, but it is also ruinous to the copper, pitting its surfaces and burning off the "tin." When the soldering copper is overheated, excessive oxidation takes place, which will in turn destroy the copper.

If the city gas is available in the workshop a bunsen burner should be used in heating the soldering copper, as it gives a clean, hot flame without noise. In the event gas is not available, the ordinary gasoline blow torch is

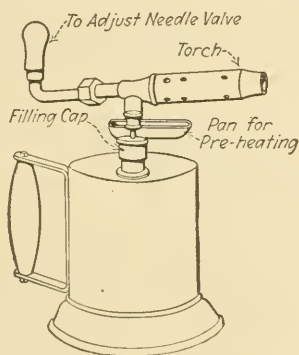

Fig. 282—A gasoline blow torch and its parts

probably the best substitute. It is possible to purchase blow torches which have a special holder on them for the soldering copper.

It might be well to say a few words here about the operation of a blow torch. A common type of torch is shown at Fig. 282. The tank is made of brass and the fuel is kept in this. The fuel tank should never be completely filled. Two-thirds full is sufficient, owing to the fact that an air pressure must also be produced within the tank, which causes the gasoline to rise and flow to the nozzle and vaporize. A little air pump is generally incorporated in the handle of the torch and this must be

operated before it is possible to start the torch. The pump should be worked until it becomes difficult to continue the strokes, owing to the back pressure of the air in the tank. When this is done the needle valve should be opened and gasoline allowed to run into the little iron receptacle directly under the torch. This is then lighted with a match and after the gasoline has become almost completely consumed through combustion, the needle valve is again opened. The gasoline issuing from the needle valve vaporizes immediately it comes in contact with the heated torch, producing a roaring hot flame sev-

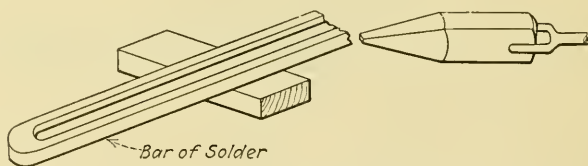

Fig. 283—Taking solder from a bar of half-and-half

eral inches long. Torches sometimes fail to operate, owing to the fact that the preheating was not sufficient to cause the gasoline to vaporize properly as it came forth. In this event the preheating should be continued until the gasoline vaporizes and burns when the needle valve is opened. From time to time it will be necessary to replenish the air supply in the tank. This is done when the flame gets shorter and less noisy.

Solder can be procured in two different forms. Ordinarily it comes in 1-lb. bars. In this form it is known as half and half. Solder is also produced in the form of wire about  $\frac{1}{8}$  in. in diameter. It is very convenient for use in this form and less experience is required in handling it. The proper method of taking solder from a bar of half and half is shown at Fig. 283. The point of the

heated copper is held in contact with the solder until a small bit melts and adheres to it. Although this sounds easy on paper it will be found much more difficult in practice. After the solder has adhered to the copper, it is brought in contact with the work to be soldered and as the copper is run along the seam or crevice slowly the solder will adhere. The wire solder is used in a different manner. The soldering copper is placed in contact with the work and a piece of wire, held in the opposite hand, is placed against the tip of the copper and held there until it melts and flows onto the work.

There is a certain brand of wire solder which carries the soldering flux in its center. After the metallic surfaces have been prepared for the application of solder, it is necessary to place a little flux over them. The flux melts as the copper comes into contact with it and prevents the surfaces from oxidizing, thereby assisting in producing a secure joint. Various kinds of soldering fluxes are on the market. Some of the prepared mixtures or formulas can be recommended and some cannot. For all ordinary purposes powdered resin will be found very suitable. This should be kept in a little jar and some of it sprinkled on the joint to be soldered. Sal-ammoniac is a very good flux to use when soldering copper, but it is not useful for other materials.

Many times it is possible to solder in the bunsen flame without the use of a soldering copper, providing the work is large enough. In this case the pieces to be soldered are held together with a pair of tongs and placed in the bunsen flame in such a way that the flame will not impinge upon the surfaces to be soldered. When the metal becomes heated sufficiently the wire solder is brought into contact with it and it will flow nicely into the joint. In

soldering very small pieces it is advisable to bring the copper into contact with them and hold it there until the pieces become heated enough to melt the solder when it is brought into contact with them. The soldering copper in this case is merely used as a medium to communicate the necessary heat to the pieces.

Sometimes it is difficult to hold two pieces in the proper position for soldering. It is oftentimes possible to use wire to bind the work together preparatory for soldering.

In places where ordinary soft solder will not hold and a very stout joint is desired, silver solder must be used. Silver solder consists of brazing spelter (brass) and pure metallic silver in varying proportions. The percentage of the metals in the composition determines the melting point and this may be anywhere from 700 degrees Fahr. to 2000 degrees Fahr. The greater the temperature necessary to fuse the silver solder and cause it to flow, the stronger the resulting joint will be. The melting point of the solder used should always be lower than that of the metal upon which it is to be used, otherwise the metal will be first to melt. For ordinary work a solder with a melting point between 700 and 800 degrees will be found to produce joints with sufficient strength. For use with copper, a solder consisting of 2 parts of silver and 1 part of brass in the form of brazing spelter, is very satisfactory. A suitable mixture for work with brass consists of 7 parts of silver and 2 parts of brazing spelter. The silver solder in sheet form can be procured from all jeweler's supply houses. This is the most convenient form in which to use it, and the time required for it to melt is greatly decreased.

Unlike soft solder, silver solder cannot be melted with



a soldering copper. It is necessary to use the flame directly upon the solder and the temperature of the flame must be sufficiently high to cause it to melt. It will be found that an ordinary bunsen flame will not be suitable. For low temperature solder an ordinary blow torch will furnish sufficient heat for small work. For a larger job, however, a larger flame must be used, as the volume of heat given by a small flame will not be sufficient, although the temperature may be high enough.

Work to be silver-soldered or brazed must be carefully cleaned by dipping it in a pickle consisting of 1 part sulphuric acid, 1 part nitric acid and 6 parts water. After the surfaces are carefully prepared they are ready for brazing. To facilitate handling, the pieces should be wired together. In brazing or silver soldering the heat should be conducted from the work itself to the solder. The flame of the torch should never be directed on the spelter itself with the idea that it is going to melt and unite with the work. It is difficult for an amateur to determine when he has produced a solid brazed joint. Sometimes what looks like a nicely soldered or brazed joint will come apart when subjected to the least strain. Insufficient heat is probably the greatest cause of poor soldering or brazing. There should always be surplus heat so that the job will get hot quick enough, which prevents the formation of troublesome oxides which make it impossible to produce a sound joint. Borax is used as a flux in brazing and silver soldering. It can be obtained in powder or lump form. If it is used in lump form it can be ground down on a little piece of slate and mixed with a little water to form a pasty cream. The borax is placed on the joint to be soldered and the flame is then brought into contact with it. After the water has evap-

orated the brazing spelter or silver solder is put in place on the joint. The flame is again directed upon the work and allowed to remain there until the spelter or solder melts and runs into the joint. To do this it will be found necessary to bring the work to a bright red heat. If the melted spelter refuses to flow into the joint something is wrong. Probably the surfaces were not completely covered with the borax and water. In this event they were oxidized by the heat of the flame and the solder would not adhere. Oftentimes mixing the spelter with a little powdered borax and water helps matters considerably. The heat should not be applied too long nor should it be

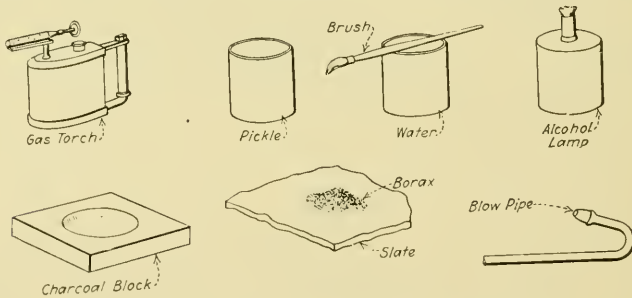

**Fig. 284—A silver soldering outfit**

taken away directly the spelter melts and runs. The flame should be directed upon the work until the spelter runs and adheres to the work in the form of a thin film. At this point the flame should be withdrawn, as there is great danger in burning the work if the flame is allowed to remain in contact with it too long. After the joint has become cool the superfluous borax may be scraped off and the joint tried for strength.

In producing a good strong joint the pieces to be joined should not be brought together too closely, as the solder will not be able to run between them. By allowing space

enough for the solder to actually get into the crevice, a good strong joint is made. It is best to lay the work being soldered or brazed upon a small charcoal block. Such a block when it becomes heated will reflect the heat or centralize it instead of carrying it away.

Another important matter is that of heating the pieces to be joined uniformly. If this is not done a sound joint will not result. Whether or not the pieces have been heated uniformly can be determined after the soldering is done by watching the work cool. If one piece stays red longer than the other this signifies that the work was not

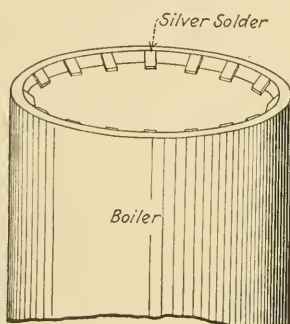

Fig. 285—Pellets of silver solder in place ready for melting

heated uniformly and it will be best to make the joint over again.

In brazing brass a little of the spelter used and a sample of the brass to be soldered should be heated under the torch to determine whether or not the melting point of the brass is below that of the spelter. For spelter with a low melting point this need not be done for copper or steel, as the melting points of these substances are far beyond that of spelter.

In silver soldering large pieces of work it will be necessary to use a small forge with coke as fuel. After a

“clean” fire is produced the work is put down in the hottest part with the surfaces to be brazed facing upward. The rest of the process is carried out in the ordinary manner.

For very small work the little outfit shown at Fig. 284 can be used successfully. The little blow pipe is placed in the mouth and the alcohol flame directed upon the work by means of blowing through the pipe. For small, delicate parts this is the only practical method.

The method of soldering the ends of a model boiler in place is shown in Fig. 285. Sheet silver solder is used and this is cut into little pellets and placed as shown. The heat is applied until the pellets melt or fuse and blow into the joint.

## CHAPTER XII

### Construction of Small Power Driven Drill Press

Design of machine—Drawings—Making the necessary patterns—Boring the spindle arm—Boring out table—Method of holding castings to lathe for boring—Use of special boring tool—Drilling—Boring bench clamp—Drilling spindle bearing—Reaming out spindle bearing—Machining pulleys on mandrel—Tapering pulleys—Cutting keyway in spindle—Tapping—Polishing—Scraping—Finishing parts—Assembling.

THE construction of the drill press described in this chapter will give the amateur mechanic an opportunity to use the knowledge he has gained by studying the foregoing chapters of this volume. The author designed and constructed this drill press especially for use in connection with this book. When finished it will be found to be an extremely useful tool and an attractive addition to the workshop. It does not involve a great deal of labor, but the machining must be carried out very carefully to assure perfect alignment and accuracy.

Before starting the actual construction of the machine the mechanic is advised to give the detail and the assembly drawings, Fig. 286 and 287, a very careful study. This will give him an idea of the operations involved in the construction of the machine and the general line of procedure.

The first thing to do is to construct the patterns. A study of the parts will show that three pieces (table, spindle-arm and bench clamp) each have a circular portion the same diameter and length. To save time and

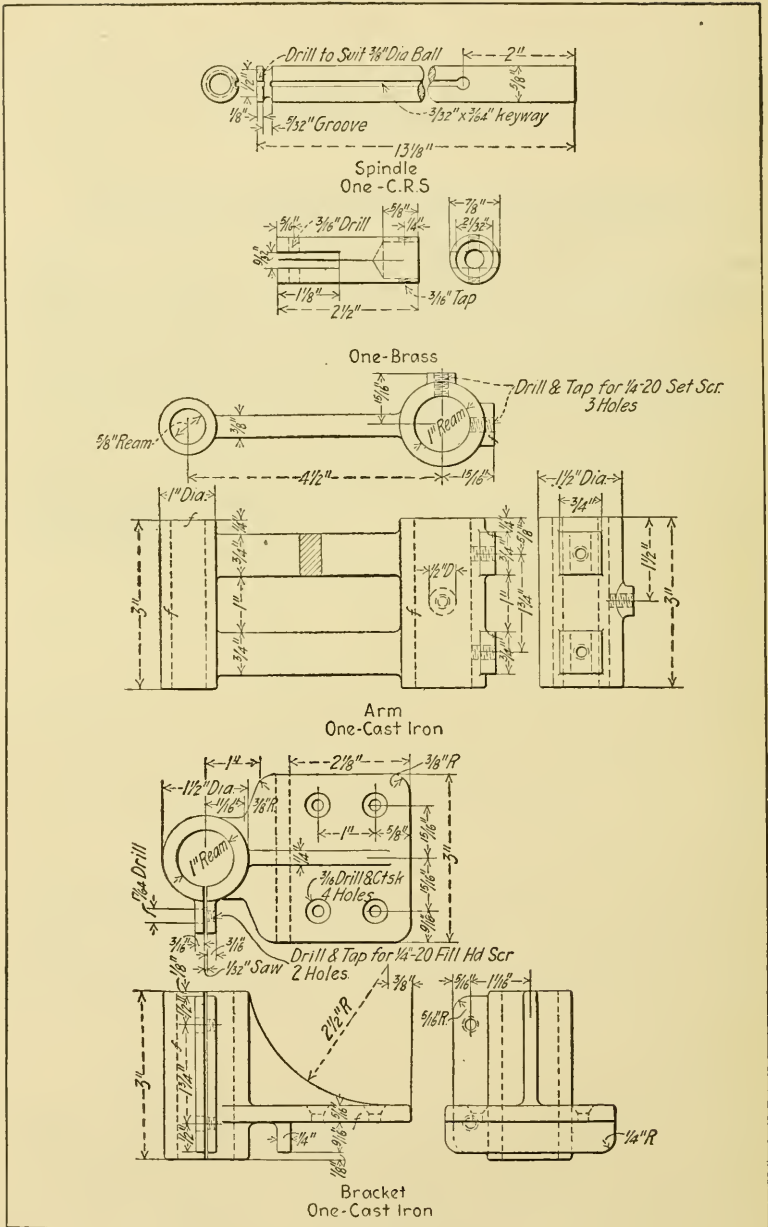

Fig. 286—Details of the power bench drill described in this chapter

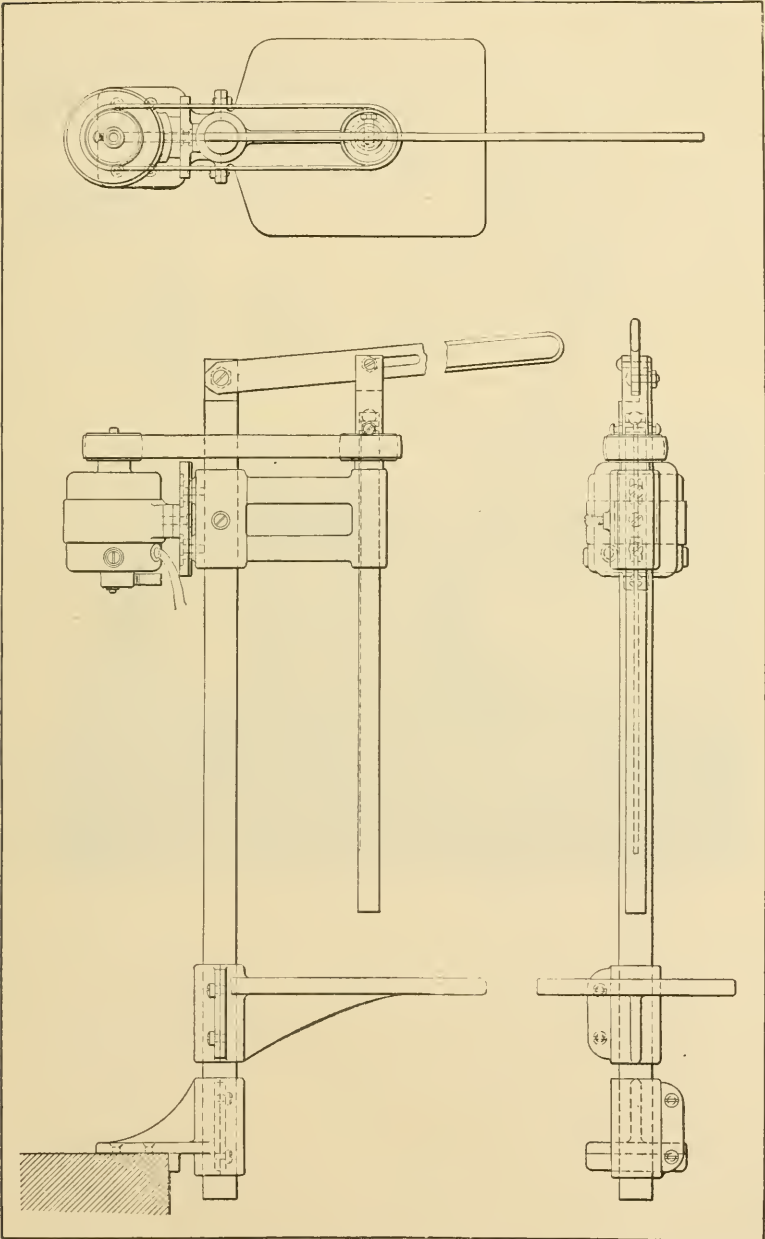

Fig. 287A—Assembly drawing of the bench drill described in this chapter





trouble it will be well to turn up a piece of the proper diameter long enough to cut these three pieces from so that it will not be necessary to go to the trouble of turning up the individual pieces. This also holds true of the core prints which are of the same diameter for the three pieces. After a piece is turned to the proper diameter, the core prints are sawed off and used when the pieces are assembled into the complete pattern. The complete set of patterns is shown at Fig. 288. Having cut the pieces mentioned, the pattern for the spindle arm can be

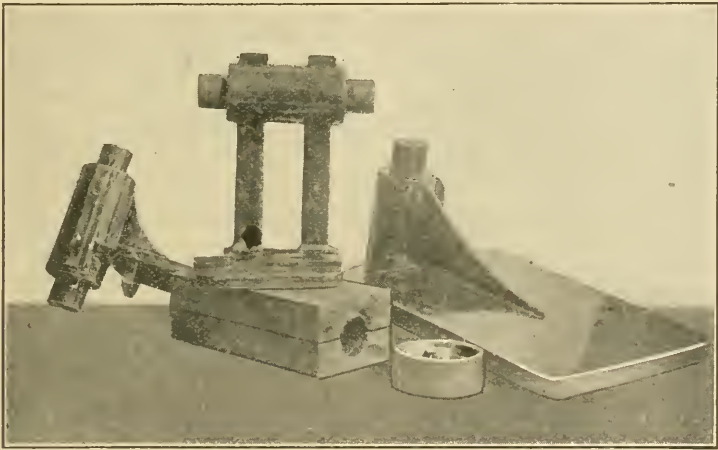

Fig. 288—Patterns for the bench drill

finished. The square portions mounted on the back of the spindle arm upon which the motor base rests are cut with one side rounded out to conform with the diameter of the piece upon which they are glued. The two square pieces that hold the spindle bearing are then cut and a square hole is cut to receive them in both the spindle bearing and the piece which slides over the standard. These holes can be cut by the aid of a sharp knife and the writer advises the builder to use care in seeing that

a nice fit is produced. Before applying the glue, the square should be brought into use to make sure that these pieces are mounted properly, otherwise the spindle bearing will be out of true and when it comes to drilling it out considerable trouble will be had in producing a hole which will make the spindle run in alignment with the standard and at exact right angles to the drill table, which is absolutely essential if an accurate drilling machine is to be made. The core prints are then fastened to the center of the back piece of the pattern by driving a little brad through their center and applying glue before they are finally put in place. It may be necessary to drill a hole through the center of the core prints to prevent them from splitting when the brad is driven through. The head of the brad should be driven in with a nail set and the resulting hole filled up with putty. Aside from sandpapering and shellacing, this pattern is finished and it may be set away to dry while work is continued on the remainder.

The pattern for the drill table will be made next. The table portion of the pattern is made in two pieces, glued together with their grains running at right angles. The surfaces should be perfectly smooth and the glue is then applied. The pieces are held together with clamps overnight. Contrary to the general impression, the more glue that is used the weaker the resulting job will be, therefore the builder is cautioned to use a very thin application of glue. When the boards are taken from the clamps they are cut to the proper shape and the corners rounded off nicely. A slot is then cut in the circular portion of the pattern into which the laminated board is placed. The fit should be a tight one and by an application of glue before it is forced in, a very secure joint will result.

This finished, the thin piece or support which reinforces the whole pattern and resulting casting is put in place. The top of this piece has its corners rounded off nicely. At the thin end it is held by two small brads, and one at the thick end is driven into the back of the circular portion of the pattern. Further reinforcement is secured by smearing the piece with glue before it is finally put in place. When this is done, the projecting portion of the pattern, which is afterwards slit and which forms the clamping part of the finished casting, is put in place. This is held by glue and small brads. It will be necessary to concave its surfaces with a circular file so that it will conform to the center diameter of the piece to which it is fastened. When the core prints are put in place this pattern is then set aside and work continued on the remaining patterns. It might be well to mention at this point the necessity of putting the core prints in the exact center of the circular pieces. If this is not done the hole will be cored out of true in the resulting castings. The bench clamping piece is not mentioned and by carefully examining Figs. 288 and 289 the necessary operations to produce this part will be evident, after having described the construction of the other patterns. When this pattern is finished the motor base can be produced. This is a laminated piece, built up of three separate pieces. The construction of it is best shown in Fig. 290.

The pulley is next turned up on the lathe and does not require much painstaking labor. Two pulleys are required on the finished machine but the same pattern can be used to cast them both. Although the finished pulleys are tapered slightly, a straight pattern can be produced to facilitate matters as the tapering can be machined on the pulley castings.

Having produced all the necessary patterns, attention is now directed to the production of the core box. The two blocks or halves of the core box should first be cut out and squared up. They are then clamped together and placed in the vise. A hole is then bored out through their center with an auger and bit. The bit used should have a diameter a trifle smaller than that which the finished core is to be. This is to allow for sand-papering, as the bit does not leave a well-finished hole. After the hole has been properly finished up with sandpaper, four brass pegs are driven down into one-half of the core box

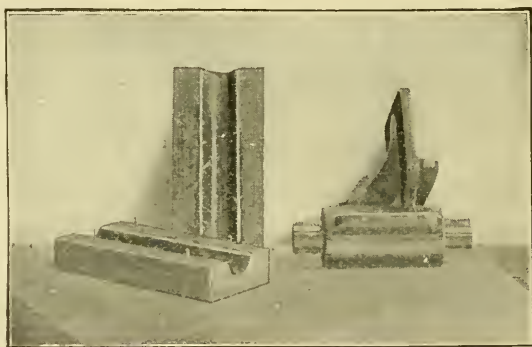

Fig. 289—The core box used for all of the cored patterns

and four holes drilled in the other half. These are to lock the core-box halves. The finished core box is shown in Fig. 289.

Having brought the patterns to shape they are all given a thorough sandpapering without sparing the proverbial elbow grease. The fillets are then formed with warm wax. After papering them down nice and smooth, they are all given a thin coat of shellac and set away to dry. When thoroughly dry they are given an application of sandpaper and another coat of good

orange or white shellac. This will leave them with a high, glossy surface, which will pull from the sand without allowing the sand to adhere. It should be mentioned here that the core prints are painted black or red before the shellac is applied to them.

When the castings are received from the foundry they should be cleaned up with a bastard file and all the sand removed from their surfaces.

The spindle arm can be machined first. Owing to the fact that the average mechanic does not have a one-inch

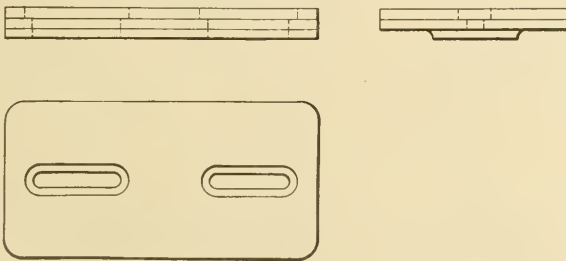

Fig. 290—Method of construction used in making the pattern for the motor base

drill or reamer in his shop, it will be necessary to bore out the cored hole of the casting with an especially made boring tool. The details of this tool are shown in Fig. 291. The holder should be made of the best tool steel. Ordinary cold rolled steel will not serve the purpose as it does not have strength enough to resist the cutting action of the cutter during the boring. The tool used in the holder should be ground as depicted. It will be noticed that two set screws hold it in place, one at the side of the holder and one at the end.

The problem of mounting the casting for boring must be considered. The lathe which the writer used did not

have a swing great enough to accommodate the casting by chucking it. Therefore, the ordinary procedure of boring could not be resorted to. It was necessary to mount the casting upon the slide rest of the lathe so that it would be held securely and so that it can be moved parallel with the lathe bed. The writer fully realizes that all lathes are not like the one upon which this machining was done, but, with few exceptions, the same general procedure can be followed. A study of Fig. 292 will re-

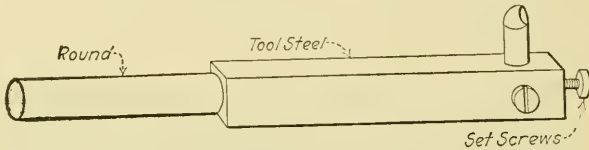

Fig. 291—A simple boring tool used in the boring work on the drill press parts

veal the method of mounting the casting upon the cross slide. The block upon which the casting rests must be planed absolutely square and made the proper height, so that when the casting is bolted down the center of the boring tool will be in the center of the cored hole. This can be determined by setting the cutter so that it will just touch the edge of the cored hole. The lathe spindle can then be turned around a couple of times to determine whether or not the tool is revolving concentrically with the hole in the casting. Before the boring is actually started, the casting should be tested with a machinist's level to determine whether or not it is level with the lathe bed and the tool. If this is not done a hole seriously out of true is apt to be bored which would destroy the casting. A level will be found on the average machinist's square. The writer made this determination, using the surface of the chuck as a basis to

work from. If the casting is not level it can be brought to a level position by placing small bits of thin sheet copper under it. The belt should be tightened sufficiently so that the casting will not move when the boring tool starts to cut.

The actual boring can now be proceeded with. The boring tool should be adjusted so that a very light cut will be taken first. The back gears of the lathe should

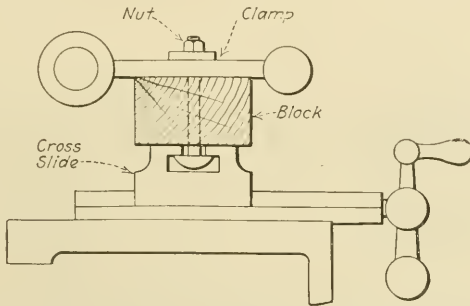

Fig. 292A—Showing how the casting is mounted to the cross slide for boring

be thrown in and the machine should be reduced to its lowest possible speed by changing the belt to the small cone pulley. The casting is advanced by moving the lathe carriage forward. The feed should be extremely slow. When the tool protrudes at the opposite end, the lathe is stopped and the carriage run back to the position shown in Fig. 292, which shows the casting mounted in the lathe. The cutting tool is then adjusted again so that it will take a cut a little greater than the previous one. The same operation is repeated until the hole gets very near the desired diameter. This can be determined by a piece of one-inch stock which can be used as a sort of gauge. Toward the end of the cutting, very light cuts should be made and if it is found that but a very small

amount of metal is to be removed to make the test piece fit, the tool can be run through and made to return while the lathe is in motion and by advancing the casting at the same speed as the ordinary feed. Thus the natural spring of the tool will remove a very small amount of

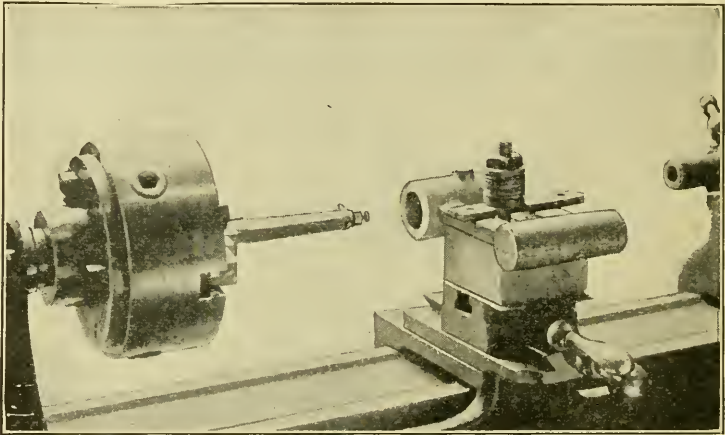

Fig. 292—The spindle bearing arm mounted on the lathe for boring

metal on the return cut which will probably bring the hole to the exact diameter. The test piece should fit without any play.

The piece is then removed and preparations made for drilling out the spindle bearing. To do this, the writer mounted the casting in the same manner but turned it over so that the bearing spindle came between the lathe centers. (See Fig. 293.) Before this operation, however, the piece was centered up at each end and marked out in the proper manner. It was mounted so that when the lathe centers were put in place their points rested in the prick punch marks which marked the center of the spindle bearing. The casting was then tested with a



level as above mentioned. This done, the centers of the lathe were removed and the chuck put in place and a small drill placed in it. The small drill is used to find the center, owing to the large web of the  $\frac{5}{8}$ -in. drill. This done, the small drill is replaced with a large one. The drill pad is then placed in the tail stock spindle. It is to be understood that the drill used in drilling the  $\frac{5}{8}$ -in.

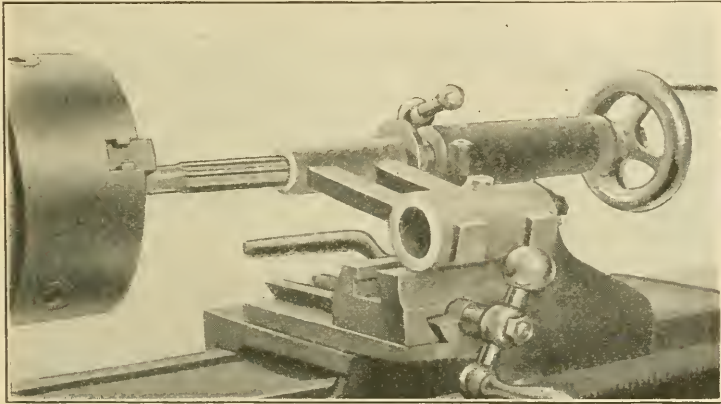

**Fig. 293A—Reaming out the spindle bearing**

hole must have its lips ground off as described in the chapter on drilling. The drilling is then proceeded with, with the back gears of the lathe in place. A very slow feed should be used, as it is quite a strain on the average small lathe to drill a hole of this diameter. After the drilling is done, the casting is again taken from its mounting and a  $\frac{5}{8}$ -in. reamer placed in the chuck of the lathe. The hole is then reamed out as shown in Fig. 293A. When the reamer has entered the casting as far as it will go, the casting should be turned around and the reamer allowed to enter the opposite end of the hole. This method of reaming is followed out so that the

reamer will follow the hole. The reamer is fed into the hole very slowly.

The flat portions of the casting upon which the motor base is mounted are then drilled. Before this is done, however, they should be filed perfectly flat and square with the top of the casting. This can be done by apply-

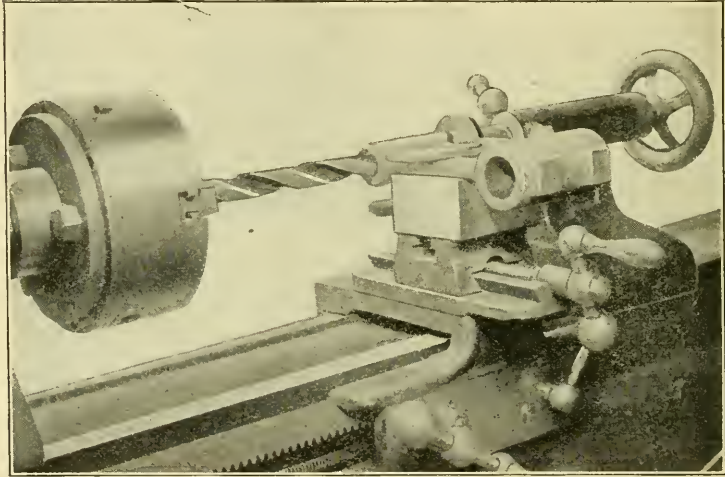

Fig. 293—Drilling out the spindle bearing

ing the square as shown in Fig. 294. Filing should be continued until these surfaces are absolutely square and flat. The holes are then marked out, drilled and tapped with a  $\frac{1}{4}$ -20 tap. A No. 7 drill is used. The same drill and tap are used in finishing the hole at the side of the casting which accommodates the set screw. This operation completely finishes the first casting, aside from enameling, which is not done until the complete machine is ready to assemble.

The bench clamping piece can be machined next. Owing to the size and shape of this piece it will be pos-

sible to mount it in the chuck and use the boring tool mounted in the tool post of the lathe. The casting is mounted as shown in Fig. 295. In mounting the boring tool in the tool post it should be brought to the proper

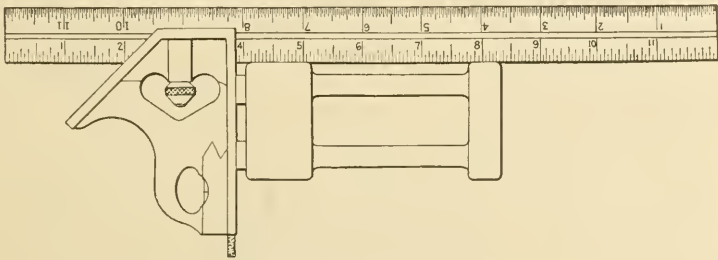

Fig. 294—Squaring up the spindle bearing casting

height so that the casting will revolve perfectly concentric with it. It should also be clamped tightly in the tool

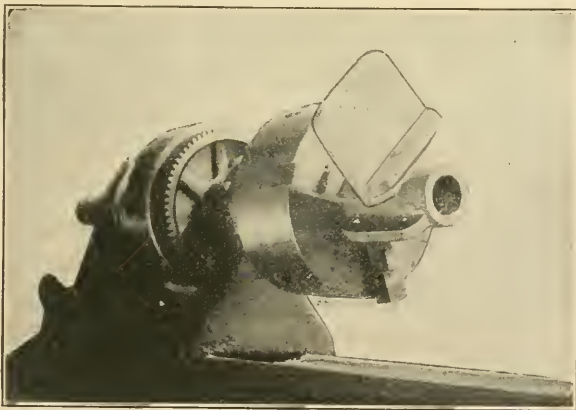

Fig. 295—The bench clamp casting mounted for boring

post to prevent it from revolving as the end of the tool which is held in the tool post is round. The first cut should be a very light one and the second one a little

heavier. In fact, the boring is carried out as it was with the spindle arm with the exception that the feed is not adjusted in the same way. Owing to the fact that the boring tool is mounted in the tool post the feed is adjusted by moving the cross slide and it is not necessary to move the tool in the holder. When the boring has been finished, the casting is removed and the holes in the plate through which the screws pass to hold it to the bench are marked out, drilled and countersunk. The next operation should be performed very carefully. It is that of splitting the projection at the side of the casting with a hacksaw. First, the dividers should be adjusted and a line scratched along the middle of the projecting piece to act as a guide for the hacksaw. The casting is then put in the vise and the cut made with the hack saw. It will be necessary to manipulate the saw very carefully at the starting of the cut so that it will cut straight. By using a little care the author was able to cut the casting almost perfect. The holes are now marked out and drilled for the clamping screws. First a No. 7 drill is used. When this is put through it is followed up to the half-way mark with a  $\frac{3}{8}$  drill which makes a clearance hole for the No.  $\frac{1}{4}$ -20 machine screw which is used to tighten or clamp the piece about the standard. When the clearance hole is made the  $\frac{1}{4}$ -20 tap is used to produce the threads in the smaller hole. This operation finishes the bench-clamping piece.

The hardest work on the whole drill press now presents itself. It is that of boring out the hole in the table. Of course, this particular job is not so difficult if the amateur has a lathe with a swing great enough to accommodate it. It will, however, become a troublesome job if a lathe this size is not at hand. It is on jobs such as

this that the mechanic must use his mind and study the work before him before he attempts to accomplish his end. It is evident that it is necessary to mount this casting upon the cross slide as was done in machining the spindle arm. The set-up for this job is shown at Fig.

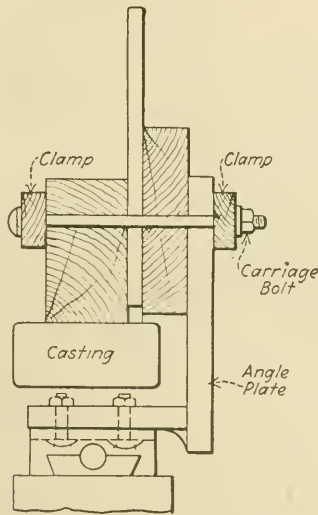
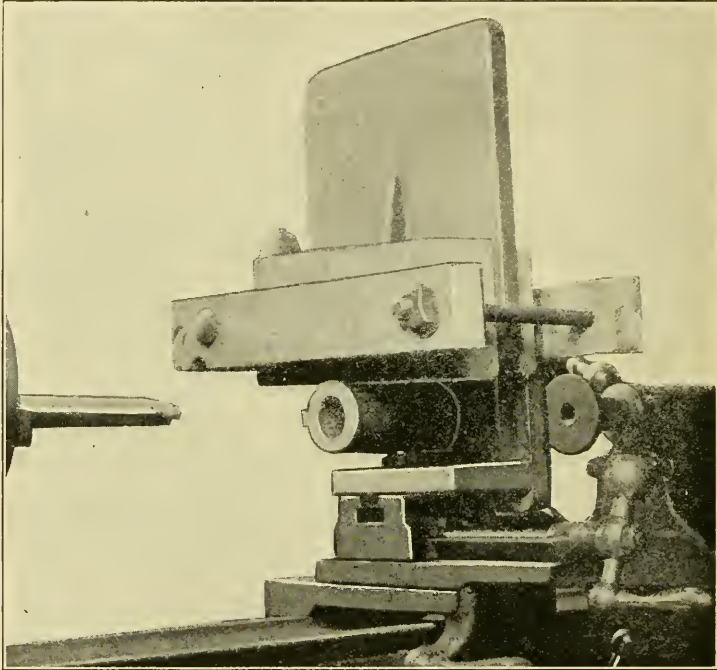

Fig. 296—How blocks are used to mount the drilling table for boring

296 and more clearly at Fig. 297. It will be seen that the lathe angle plate is first clamped to the cross slide. When the lathe angle plate is bolted tightly in place, it should be tested with the level to determine whether or not it is true. The square should also be used in making sure that the angle plate is sitting at exact right angles to the lathe bed. This done, the casting is ready to be mounted. The blocks used between the angle plate and the casting must be planed down so that they are perfectly true. The two strips of clamps which strap the casting to the angle plate should be cut from hard wood,

otherwise they would be apt to snap when the clamps are bolted tightly. Before the clamping bolts are tightened, the casting should be brought into a concentric position



**Fig. 297—The drilling table of the drill press mounted in the lathe for boring**

in relation to the cutting tool which is in the chuck. It may be necessary to place a couple of small blocks under the casting to bring it to this position. When in this position, the adjusting screws on the cross slide of the lathe should be tightened so that there will be no danger of its moving through accident. The boring is then done in the usual manner. The casting is then removed and the projecting side pieces split with a hack saw in the manner previously described. It is also drilled and

tapped in the same way. The remaining operation, aside from enameling, is that of grinding the surfaces of the table. The writer did not have the facilities for doing

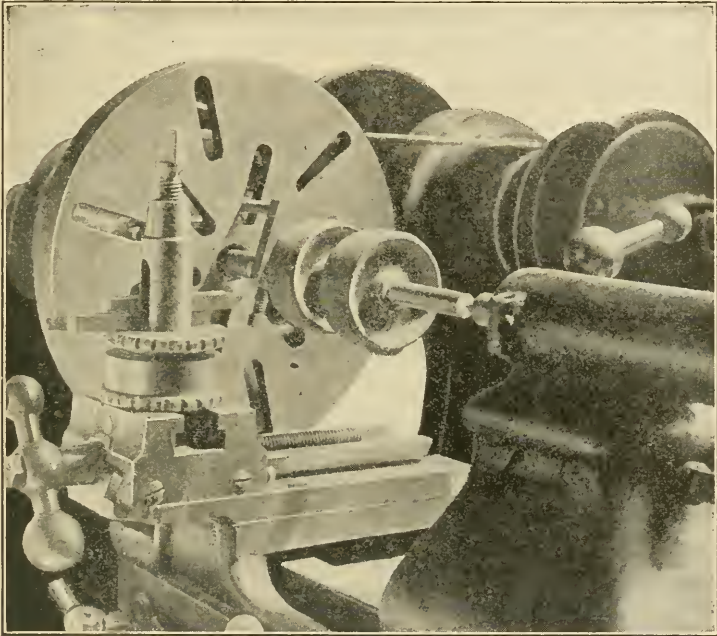

Fig. 298—The pulleys mounted for facing

this and he knows that the average amateur mechanic will not have the necessary equipment to perform this operation. This piece was therefore taken to a local machine shop where the job was done on a surface grinder and the charge was \$1.00. This gives a perfectly smooth and true surface.

The pulleys can now be machined. The first operation is that of drilling out the hubs preparatory to mounting them on a mandrel. To do this they are mounted in the

chuck and drilled out with an 11/32-in. drill which is mounted in the drill chuck placed in the tail stock spindle. This is followed with a 3/8-in. reamer. (Note: This is a very convenient set to have on hand.) A piece of 3/8-in. cold rolled steel about 6 in. long is now mounted in the lathe and faced off true at each end. The centering drill is also used on each end of the piece to produce the proper centers for the lathe. The pulleys are then forced upon the mandrel and mounted in the lathe as shown in Fig. 298. Owing to the fact that the surfaces of the pulleys taper in opposite directions, the back center of the lathe is off-set about 3/8 of an inch. This is done by loosening the set screw on the tail stock. After the center is off-set the proper distance the set screw is again tightened. A diamond-point tool is then used in turning down the pulleys. Owing to the fact that the pulleys are mounted off center for taper turning, it will be found that the tool cuts only at one side. This side of the pulley is turned down until the cut reaches the center or a little over. The mandrel is then taken out of the lathe and turned completely around with the dog mounted on the opposite end. This brings the opposite side of the pulley into cutting position. This is then turned down in the same way as the other sides. The second cut should be so regulated that the two tapers meet exactly in the center of the pulley. The mandrel is then taken from the lathe and the back center brought to its proper position. This can be easily done by mounting the live center in the head stock and adjusting the tail stock center until the two points exactly meet. The mandrel with the pulley is again placed in the lathe and the surfaces given a further finish by the use of a smooth file. After the file is used, the surfaces should be pol-



ished with fine grit Carborundum cloth. The pulleys are then laid away for future use.

The standard of the machine is cut from a piece of standard one-inch cold rolled stock. Half of the top is cut away with a hack saw as shown in the drawing. This should be marked out first so that the lines can be followed with the hack saw. After the piece is cut out the

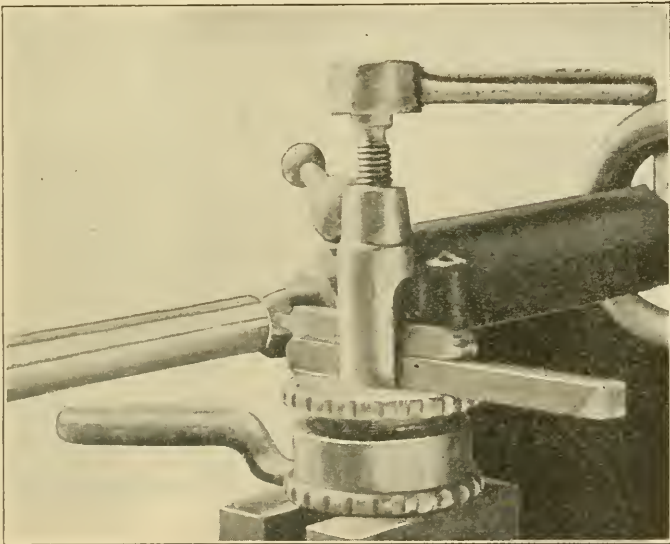

**Fig. 298A—The lathe tool in place for cutting the key-way**

surfaces are finished up with a smooth file and the hole shown drilled. The standard should then be mounted in the lathe using the center rest. When revolving at high speed, it can be polished with fine grit Carborundum cloth. After it is nicely polished it should be carefully wiped off with a piece of waste soaked in machine oil. This will prevent it from being attacked by moisture and it will also cause the casting which slides over it to move freely without sticking.

The drilling spindle can be made at this time. It is a piece of  $\frac{5}{8}$ -in. cold rolled stock. It is mounted in the lathe with the center rest and a keyway is cut as mentioned in Chapter VII. (See Fig. 298A.) The cutting tool should be  $\frac{1}{8}$  inch wide. Very light cuts should be taken until the tool goes sufficiently deep into the metal to guide itself. It will be found necessary to sharpen the tool several times when this job is being done. After the keyway is cut and while the spindle is still mounted, the groove shown in the drawing is cut with a round-nosed tool. It is well to mention here that the stock from which the spindle is cut should be  $1\frac{1}{2}$  in. longer than necessary. This is important because the cutting tool, which is used to produce the groove, cannot be brought very close to the center rest. After the groove is cut, the shaft is again taken out of the lathe. It will then be necessary to take the center rest off and also the lathe carriage. The center rest is then put on first and followed by the lathe carriage. The shaft is then mounted in the center rest and the superfluous stock cut off. It will be seen that it is impossible to bring the cutting tool to the proper position for cutting off the end of the spindle unless the position of the lathe carriage and center rest are reversed. The "dimple" which accommodates the ball bearing is then made with a  $\frac{3}{8}$ -in. drill. (See Fig. 298B.) The spindle is then turned around and the end of it threaded to receive the drill chuck. The pitch of the thread cut will be determined by the chuck used. A small chuck can be purchased from drill manufacturers and the mechanic is not advised to try to make one himself. It is not worth the time and trouble when one can be had for about \$3.00.

The handle which actuates the drill press is now made.

This is such a simple part of the machine that it seems needless to describe the operations involved in making it.

The socket is now made in which the upper end of the spindle revolves. This particular part is shown in the detail drawing of the drill. There is nothing very unusual about the construction of this piece as it only in-

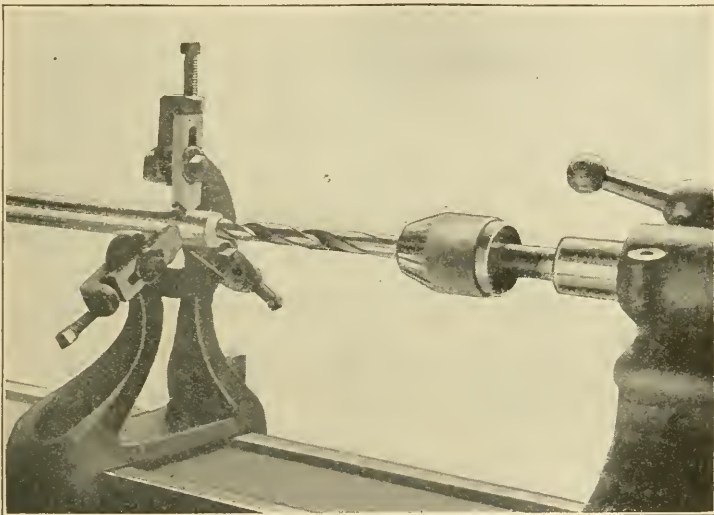

**Fig. 298B**—Drilling the dimple in the end of the spindle

volves a few simple lathe operations which can be determined by a glance at the drawing. After the slot is cut with a hack saw it should be filed nice and smooth so that there will be no danger of friction between it and the handle. Before the slot is cut out, the holes which accommodate the screw which holds the handle in place should be drilled. The piece should also be polished up nicely to finish it.

The base of the motor can be finished at this point.

There is very little work to be done on it. The mechanic will be able to test his accuracy in flat filing by bringing the slide or raised portion of the base to as near a perfect plane as possible. The holes or slots through which the holding screws pass are then finished with a small flat file and a round file. The motor which the writer used had a detachable base and therefore the little block shown

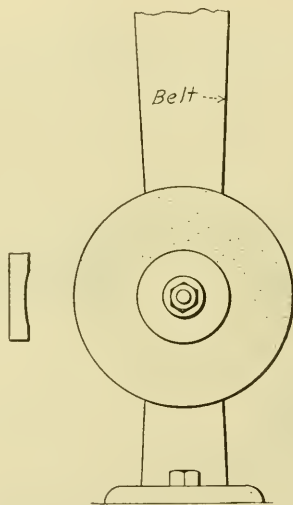

Fig. 299—How the motor base piece is ground

in the drawing was placed between the motor and the base just described. The block was ground out to accommodate the contour of the motor. This was done by the aid of a small grinding wheel which happened to be at hand and which was about the same diameter as the motor base. The method of grinding is shown in Fig. 299. After this piece is ground, a clearance hole is drilled in it for a No.  $\frac{1}{4}$ -20 machine screw. A hole in the motor base is drilled out and counter-sunk as shown in the

drawing. This hole is to accommodate a flister head,  $\frac{1}{4}$ -20 machine screw which holds the motor to the base.

One of the pulleys is now drilled and reamed out to fit on the drill spindle. This of course, is done with the

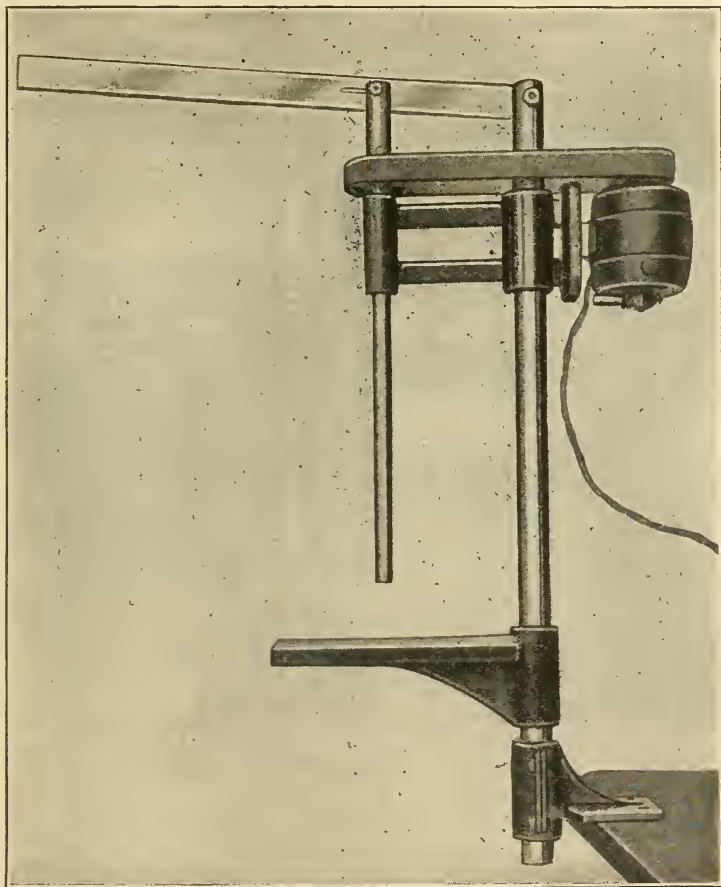

Fig. 300—The finished drill ready for work

same drill and reamer that was used in cutting the spindle bearing. When this is done the pulley is mounted in the vise and a keyway cut in it with a small hack saw.

This keyway should have the same width as the keyway in the spindle. Two slots the width of the keyway are cut with a hack saw and the superfluous metal between them chipped out with a narrow chisel. A small key is then cut out and it should be forced in the keyway of the pulley. The opposite half of the key should be filed just

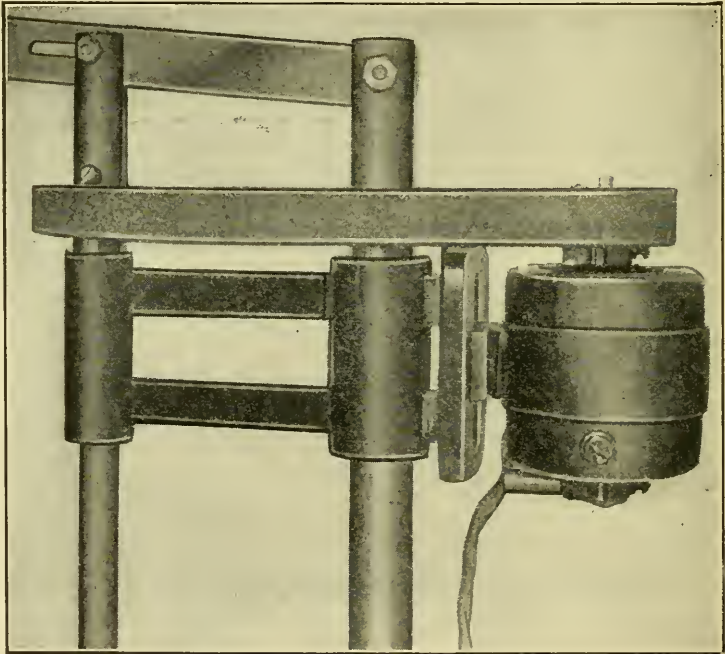

Fig. 300A—A close-up view of the motor

a little smaller so that it will slip freely into the keyway of the spindle.

All the castings of the machine are now carefully enameled and set away to dry. When they are dry the assembling of the machine can be proceeded with. This will be made very clear by studying the assembly draw-

ing and the photograph of the complete machine which appears in Fig. 300 and 300A. The pulley which fits on the motor shaft will probably have to be plugged with a piece of brass and drilled out with a proper-sized drill. The hole is also then drilled and tapped for the set screw. After the machine is assembled, the belt should be cut and laced. When this is done the machine is ready for work.

## CHAPTER XIII

### Construction of a Small Grinding Head

Patterns—Design—Castings—Preparation of castings for machining  
—Drilling the main casting—Machining pulley—Turning bearing  
—Making shaft—Machining flange—Finishing—Assembly.

THE little grinding head described in this chapter will make a very suitable and useful addition to the small shop and it can be produced with very little labor. Only two castings are used in the whole machine, one for the frame and one for the pulley. Therefore two patterns must be produced. The castings necessary for the machine are shown in Fig. 301. In producing this machine the author found it possible to use the pulley pattern contained in the set of patterns for the drill press, owing

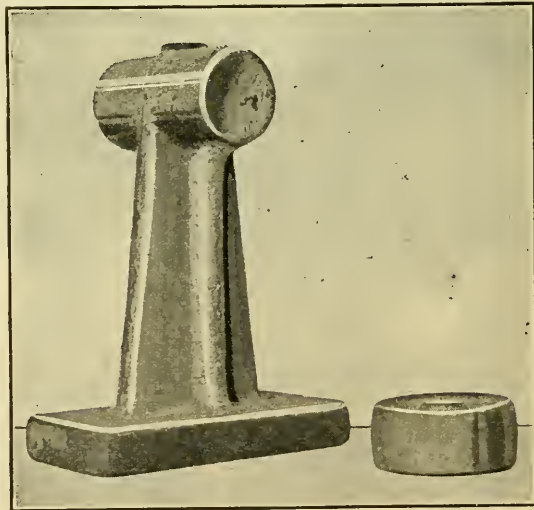

Fig. 301—The necessary castings for the grinding head



to the fact that the shaft of the machine described is  $\frac{5}{8}$  in. in diameter.

When the casting is received, the first operation will be that of cleaning it up with a bastard file. The corners of the file should be worked into the corners of the casting to scrape all the moulding sand and scale out. After this is done, the circular portion of the casting is marked out preparatory to drilling. The center is then made with a smaller drill and this is replaced in the chuck with a one-inch drill which is used in boring the hole. The

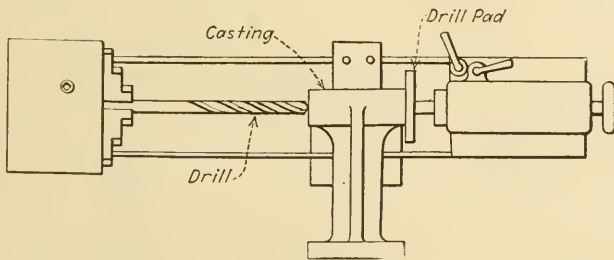

Fig. 302—Drilling out the bearing of the grinding head

back gears are thrown in for this operation and the small pulley used. A drill of this size is just about the limit on a small lathe and the feed should be very slow. The lips of the drill should also be ground off before starting to drill the hole. The opposite end of the casting rests against the drill pad as shown in Fig. 302.

The drawing of the complete machine and its various parts is shown at Fig. 303. A study of the drawing will reveal the extreme simplicity of the little device.

After the two holes are drilled for the holding down screws in the base of the casting, it should be set aside and work started on the brass bushing which fits into the hole just drilled. The brass stock used in turning the bushing should first be turned down to size. The bush-

ing should fit snugly in the hole. A forced fit is not absolutely necessary unless the mechanic is well able to produce it as it is possible to hold the bushing in place with a couple of pins, although this is not shown in the drawing. After the piece has been turned down to size a  $\frac{5}{8}$ -in. drill is placed in the tail stock spindle and the center drilled out for a distance of three inches. The parting tool is then placed in the tool post and the bushing cut off  $2\frac{7}{8}$  in. long. It is then mounted in the chuck and reamed out with a  $\frac{5}{8}$  reamer. The reamer should be fed in slowly and it will be found that a nice smooth surface will result. The bushing can now be placed in the hole in the casting. If a forced fit has not been produced, two small holes can be drilled in the top of the casting through the bushing and a couple of brass pins inserted. If the pins protrude in the inside of the bearing the reamer can be carefully run through to cut them off. A file should then be used in flushing off the ends of the bushing with the casting. In fact, it is best to cut the bushing a little long so that it will protrude a little at each end. A much better appearing job is produced when the bushing can be filed down flush with the surface of the casting. If it is necessary to resort to pins to secure the bushing in place it will be best to drill the oil hole before the reamer is inserted so that the burr left will be taken off. The oil hole is counter-sunk with a larger drill or a regular counter-sink.

The pulley is machined next. This is accomplished as described in Chapter XII and the writer believes this will be too fresh in the mechanic's mind to require a repetition. After being machined, the pulley is placed in the chuck and drilled and reamed out with a  $\frac{5}{8}$ -in. reamer. An  $11/32$ -in. drill is used to produce the hole. The drill



pad is then placed in the tail stock of the lathe and by the aid of a large V-block the hole for the set screw is drilled in the pulley with a No. 26 drill and tapped out to receive a 1-24 machine screw. The hole is counter-bored with a  $\frac{1}{4}$ -inch drill to accommodate the flister head of the machine screw used. This operation finishes the pulley and attention will now be directed to the spindle. The spindle is turned from a piece of 2-in. cold rolled steel stock 7 in. long. One end of this piece should first be mounted in the chuck, faced up, and one center drilled out with a centering drill. The center of the lathe is then placed in the center hole in the stock and the turning started. The major portion of the stock can be cut away with a diamond-pointed tool. It will be necessary to use both the right and left-hand tool as the spindle is divided into two parts by the flange. After the spindle has been turned within a thousandth of an inch of its final diameter, the remaining stock can be taken off with the Carborundum cloth as a polished finish is essential to reduce the friction and it would be impossible to produce a suitable surface by the aid of the lathe cutting tool. When this is done, the parting tool is placed in the tool post and the piece cut off. It is then mounted in the chuck and threaded. The writer used the same thread on this piece as he used on the drill press as it is often convenient to use a drill chuck on the grinding head in polishing small pieces of circular stock. It will be remembered that the diameter of the spindle in the grinding head and the spindle in the drill press are the same, therefore this plan is feasible. The nut is turned up, bored out and drilled. Two flat surfaces are then made by sawing off opposite sides and finishing them with a file. From the remainder of the stock from which the

spindle was cut the loose flange is turned to shape. The hole in the flange is drilled out with a  $\frac{5}{8}$ -in drill a trifle over size so that it will fit over the spindle freely without causing damage to the threads. The hole in this member should really be about  $41/64$ .

The parts of the machine are now ready to be assembled. Before the final assembling is done, however, the main casting should be carefully enameled as well as the sides of the pulley. The spindle is placed in the bushing and the pulley placed on the opposite end. The pulley should not be crowded too close to the bushing before the set screw is tightened as this will cause the spindle to bind. There should really be about  $1/32$  in. play. It will be seen that the abrasive wheel is put in place between the flanges and held with a nut. The reader is cautioned not to squeeze the wheel too tightly and it is best to use two little circular pieces of blotter between the flanges and the wheel. If the bushing on the wheel is too large or if it is impossible to get a wheel of the desired grit and bond with a  $\frac{5}{8}$ -in. bushing, one with a larger bushing can be purchased and fitted with a brass or wooden bushing which will go over the spindle.

A word may be said about driving the machine. If a line shaft is in the shop, a pulley at least ten times the diameter of the pulley on the spindle should be used. This speed may be a trifle too high for the efficient operation of most grinding wheels, but it is necessary if polishing is to be done. Therefore, it is best to operate the machine at this speed at all times and sacrifice the little cutting efficiency which will result so that polishing can be done. Small rag wheels suitable for this little grinding head can be purchased at polisher's supply houses and they are fastened in place in the same manner as the

grinding wheel. As it is best to use as large a polishing wheel as possible, it may be advisable to cut out a couple of wooden flanges to be used with such a wheel, owing to the fact that the flanges on the grinder are too small.

If an independent motor is used to drive the grinding head it should deliver at least 1/16 H.P. A controlling

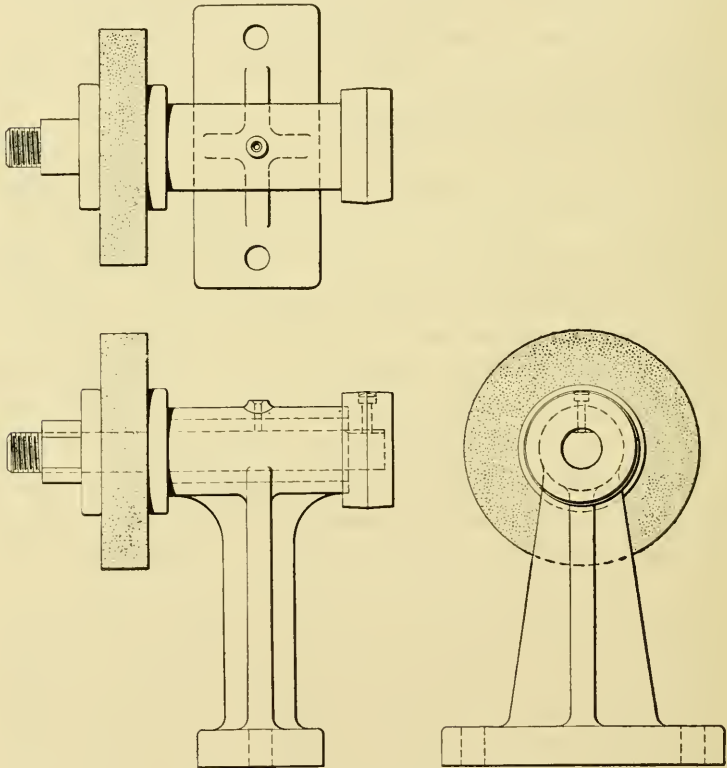

Fig. 303A—The assembled grinding head

rheostat would also be a very suitable addition to the outfit so that various speeds could be produced and the grinding wheel operated at that specified velocity as noted on the tag attached to it when purchased.

## CHAPTER XIV

### General Information

How to read mechanical drawings—General or assembly drawings—Detail drawings—Sectional drawings—Lines and what they mean—Abbreviations—A. S. M. E. screw standards—Drills to use for taps—S. A. E. standards—Grinding wheel grades—Table of allowances for driving, running forced and pushed fits—Miscellaneous mathematical information.

IN THIS chapter the author has included such information and tables as he thought would prove useful to the mechanic in his shop work. It is intended to support the forerunning portion of the book as a handy reference for general information.

Few young mechanics know how to read a drawing properly. The following notes will do much to make this clear with very little study on the part of the reader.

A general or assembly drawing shows all the parts of the machine or device located in the proper position and just as they will be on the finished machine. It is really a detailed picture of the machine as it will appear when finished. Such drawings are always made to scale; they are reduced to one quarter, one-half or one-third size, depending upon the size of the device. Some machines are so small that they are drawn full size. When a machine is drawn to a certain scale, the scale is always mentioned in the corner of the sheet.

A detail drawing shows the separate parts of a machine and how they are to be finished. The smaller

details or parts are generally massed together on one sheet while the larger details may require a whole sheet. Detail drawings are always dimensioned.

Sectional drawings show assembled parts and separate parts. Sectional means that they are drawn to show just how the part looks through the center or as if the piece or pieces had been sliced through the center. Sectional drawings are really the most important from the mechanic's standpoint, as they give most of the necessary in-

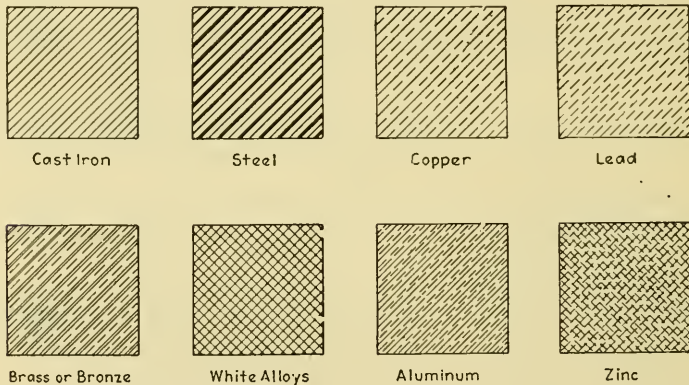

**Fig. 304—How the different metals are represented on a mechanical drawing**

formation. The cross-section of different metals is represented by different lines. (See Fig. 304.)

A real complete drawing always includes a list of screws and bolts to be used on the assembled machine and parts. Although such a list is not really important, it greatly facilitates matters for the mechanic.

Different lines on a drawing each have meanings of their own. The commonly used lines are shown in Fig. 305 together with their meaning.

Abbreviations are used extensively in mechanical



drawing and the mechanic must be entirely familiar with their meaning. The following list includes all of the conventional abbreviations used:

Scrape.—Surface is to be scraped by hand.

R.H.—Right hand.

Finish.—Surface is to be finished.

L.H.—Left hand.

"—Inches.

'—Feet.

Grind.—Surface is to be ground.

W.I.—Wrought iron.

C.I.—Cast iron.

M.S.—Machine steel.

T.S.—Tool steel.

C.R.S.—Cold rolled steel.

C.S.—Carbon steel.

H.S.S.—High speed steel.

Bore.—Hole to be bored.

Ream.—Hole to be reamed out.

Tap.—Hole to be tapped.

Drill.—Hole to be drilled.

Thd.—Thread.

Rad.—Radius.

U.S.S.—United States standard.

Dia.—Diameter.

A very useful table and data sheet for machine screws up to No. 14 is shown in Fig. 306. As mentioned in the Preface, the author is indebted to Mr. Dwight S. Simpson for this splendid piece of work. The author takes the liberty of quoting Mr. Simpson directly:

“A glance at the table shows that it is not so simple to buy a screw as it might seem. For instance, we ask

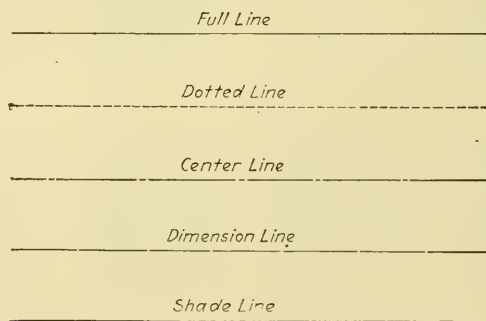

the clerk for a No. 5 screw. Doubtless we know whether we want a counter-sunk head, round head, flat or oval filister head (hex. heads we have to make ourselves from commercial hex. rod, as indicated in column fifteen), but we are liable to get a thread of 30, 32, 36, 40 or 44 pitch. Possibly we may get the so-called United States standard thread, but we might get a "V" thread which may be "exact" or "oversize," the amount of oversize being governed by the idiosyncrasies of the firm that made the screw. Thus, there can be thirty or more quite different screws all of which are rightly called No. 5. Therefore, it is necessary to select a thread and the



**Fig. 305—Different lines in mechanical drawing**

question is, "Which?" Bill Jones will, of course, get the thread that will fit a tap which he has—probably purchased in the above haphazard manner. This is possibly all right, but trouble comes when Bill does a little work for Tom Smith. Tom's tap is for a different thread.

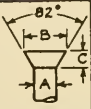
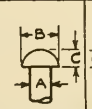
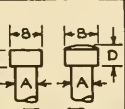
It will be interesting to the amateur to learn that this trouble occurred in many big shops, and years ago some engineers got together and after much theorizing and talk formulated rules and established dimensions for

| NOMINAL<br>SCREW SIZE | THREADS<br>PER INCH | DIAMETER<br>OF SHANK<br>A | DRILL NO.<br>FOR SHANK | DRILL NO.<br>FOR TAP |  |       |  |       |  |       |       |       |  |                  | USE COMMERCIAL<br>HEX ROD-SIZE<br>STEEL SCREWS<br>USE <sup>1</sup> FOR BRASS | STRENGTH OF<br>STEEL SCREWS<br>USE <sup>1</sup> FOR BRASS |
|-----------------------|---------------------|---------------------------|------------------------|----------------------|---|-------|---|-------|---|-------|-------|-------|---|------------------|--|---|
|                       |                     |                           |                        |                      | B   | C     | B   | C     | B   | C     | D     | B     | E   |                  |  |   |
| 0                     | 80                  | .0600                     | 5 2                    | 5 6                  | .1120   | .0290 | .1060   | .0420 | .0894   | .0376 | .0496 | .1200 | .1386   | $\frac{7}{8}$ "  | 20   |   |
| 1                     | 64                  | .0730                     | 4 8                    | 5 3                  | .1380   | .0370 | .1300   | .0510 | .1107   | .0461 | .0609 | .1460 | .1686   | $\frac{5}{32}$ " | 30   |   |
| ASME                  | 72                  |                           |                        | 53                   |   |       |   |       |   |       |       |       |   |                  |  |   |
| 2                     | 48                  | .0842                     | 4 4                    | 5 0                  | .1631   | .0454 | .1544   | .0672 | .1350   | .0549 | .0675 | .1684 | .1945   | $\frac{5}{32}$ " | 37   |   |
|                       | 56                  |                           |                        | 49                   |   |       |   |       |   |       |       |       |   |                  |  |   |
| ASME                  | 64                  |                           |                        | 48                   |   |       |   |       |   |       |       |       |   |                  |  |   |
| 3                     | 40                  | .0973                     | 3 9                    | 4 9                  | .1894   | .0530 | .1786   | .0746 | .1561   | .0634 | .0780 | .1946 | .2248   | $\frac{3}{16}$ " | 48   |   |
|                       | 48                  |                           |                        | 47                   |   |       |   |       |   |       |       |       |   |                  |  |   |
| ASME                  | 56                  |                           |                        | 45                   |   |       |   |       |   |       |       |       |   |                  |  |   |
| 4                     | 32                  | .1105                     | 3 3                    | 4 6                  | .2155   | .0605 | .2028   | .0820 | .1772   | .0720 | .0886 | .2210 | .2553   | $\frac{3}{32}$ " | 57   |   |
|                       | 36                  |                           |                        | 45                   |   |       |   |       |   |       |       |       |   |                  |  |   |
|                       | 40                  |                           |                        | 44                   |   |       |   |       |   |       |       |       |   |                  |  |   |
| ASME                  | 48                  |                           |                        | 43                   |   |       |   |       |   |       |       |       |   |                  |  |   |
| 5                     | 30                  | .1236                     | 3 0                    | 4 3                  | .2421   | .0681 | .2270   | .0894 | .1984   | .0806 | .0992 | .2472 | .2855   | $\frac{1}{4}$ "  | 75   |   |
|                       | 32                  |                           | $\frac{1}{8}$ "        | 42                   |   |       |   |       |   |       |       |       |   |                  |  |   |
|                       | 36                  |                           |                        | 41                   |   |       |   |       |   |       |       |       |   |                  |  |   |
|                       | 40                  |                           |                        | 39                   |   |       |   |       |   |       |       |       |   |                  |  |   |
| ASME                  | 44                  |                           |                        | 38                   |   |       |   |       |   |       |       |       |   |                  |  |   |
| 6                     | 30                  | .1368                     | 2 8                    | 3 8                  | .2684   | .0757 | .2512   | .0968 | .2195   | .0892 | .1097 | .2736 | .3160   | $\frac{9}{32}$ " | 96   |   |
|                       | 32                  |                           |                        | 37                   |   |       |   |       |   |       |       |       |   |                  |  |   |
|                       | 36                  |                           |                        | 36                   |   |       |   |       |   |       |       |       |   |                  |  |   |
| ASME                  | 40                  |                           |                        | 35                   |   |       |   |       |   |       |       |       |   |                  |  |   |
| 7                     | 30                  | .1500                     | 2 4                    | 3 3                  | .2947   | .0832 | .2754   | .1042 | .2406   | .0978 | .1203 | .3000 | .3465   | $\frac{5}{16}$ " | 112  |   |
|                       | 32                  |                           |                        | 32                   |   |       |   |       |   |       |       |       |   |                  |  |   |
| ASME                  | 36                  |                           |                        | 31                   |   |       |   |       |   |       |       |       |   |                  |  |   |
| 8                     | 24                  | .1631                     | 1 9                    | 3 1                  | .3210   | .0908 | .2996   | .1116 | .2617   | .1063 | .1308 | .3262 | .3768   | $\frac{5}{16}$ " | 148  |   |
|                       | 30                  |                           |                        | 31                   |   |       |   |       |   |       |       |       |   |                  |  |   |
|                       | 32                  |                           |                        | 30                   |   |       |   |       |   |       |       |       |   |                  |  |   |
| ASME                  | 36                  |                           |                        | 29                   |   |       |   |       |   |       |       |       |   |                  |  |   |
| 9                     | 24                  | .1763                     | 1 6                    | 3 0                  | .3474   | .0984 | .3238   | .1190 | .2828   | .1149 | .1414 | .3326 | .4073   | $\frac{1}{2}$ "  | 162  |   |
|                       | 28                  |                           |                        | 28                   |   |       |   |       |   |       |       |       |   |                  |  |   |
|                       | 30                  |                           |                        | 28                   |   |       |   |       |   |       |       |       |   |                  |  |   |
| ASME                  | 32                  |                           |                        | 26                   |   |       |   |       |   |       |       |       |   |                  |  |   |
| 10                    | 24                  | .1894                     | 1 1                    | 2 6                  | .3737   | .1059 | .3480   | .1264 | .3040   | .1235 | .1520 | .3788 | .4375   | $\frac{3}{8}$ "  | 186  |   |
| ASME                  | 30                  |                           |                        | 24                   |   |       |   |       |   |       |       |       |   |                  |  |   |
|                       | 32                  |                           |                        | 24                   |   |       |   |       |   |       |       |       |   |                  |  |   |
| 12                    | 20                  | .2158                     | $\frac{7}{32}$ "       | 24                   | .4263   | .1210 | .3922   | .1412 | .3462   | .1407 | .1731 | .4316 | .4985   | $\frac{1}{4}$ "  | 240  |   |
|                       | 22                  |                           |                        | 20                   |   |       |   |       |   |       |       |       |   |                  |  |   |
|                       | 24                  |                           |                        | 19                   |   |       |   |       |   |       |       |       |   |                  |  |   |
| ASME                  | 28                  |                           |                        | 18                   |   |       |   |       |   |       |       |       |   |                  |  |   |
| 14                    | 20                  | .2421                     | $\frac{1}{4}$ "        | 15                   | .4790   | .1362 | .4364   | .1560 | .3884   | .1578 | .1942 | .4842 | .5592   | $\frac{1}{2}$ "  | 306  |   |
|                       | 22                  |                           |                        | 11                   |   |       |   |       |   |       |       |       |   |                  |  |   |
| ASME                  | 24                  |                           |                        | 10                   |   |       |   |       |   |       |       |       |   |                  |  |   |
| 16                    | 16                  | .2684                     | I                      | 12                   | .5316   | .1513 | .4806   | .1708 | .4307   | .1750 | .2153 | .5368 | .6200   | $\frac{1}{2}$ "  | 388  |   |
|                       | 18                  |                           |                        | 8                    |   |       |   |       |   |       |       |       |   |                  |  |   |
|                       | 20                  |                           |                        | 7                    |   |       |   |       |   |       |       |       |   |                  |  |   |
| ASME                  | 22                  |                           |                        | 3                    |   |       |   |       |   |       |       |       |   |                  |  |   |

FOR FULL STRENGTH—THREADS SHOULD TAKE HOLD  $\frac{1}{2}$  A — (DIA OF SCREW)

Fig. 306—Data chart for machine screws up to No. 14

screws from 0 to 30 (nominal size), which have been known ever since as the American Society of Mechanical Engineers (or A. S. M. E.) standard. It will be seen by the table that these are fine pitch threads compared to the others of their size. This is advisable, as fine threads reduce the tendency to shake and do not reduce the strength of the screw. (Where fine work is required, such as in our model and experimental machines, I believe it is impossible to use too fine a thread.)

Now let us see what we get when we buy a No. 5 A. S. M. E. screw. First it has a U. S. standard form of thread with a pitch of 44 threads per inch. Maximum and minimum dimensions are specified as follows:

*Outside Diam.*

|                  |       |
|------------------|-------|
| Maximum .....    | .125  |
| Minimum .....    | .1210 |
|                  | _____ |
| Difference ..... | .0040 |

*Pitch Diam.*

|                  |       |
|------------------|-------|
| Maximum .....    | .1102 |
| Minimum .....    | .1082 |
|                  | _____ |
| Difference ..... | .0020 |

*Root Diam.*

|                  |       |
|------------------|-------|
| Maximum .....    | .0955 |
| Minimum .....    | .0910 |
|                  | _____ |
| Difference ..... | .0045 |

The A. S. M. E. taps for this screw are similarly regulated as follows:

*Outside Diam.*

|                  |       |
|------------------|-------|
| Maximum .....    | .1301 |
| Minimum .....    | .1263 |
|                  | <hr/> |
| Difference ..... | .0038 |

*Pitch Diam.*

|                  |       |
|------------------|-------|
| Maximum .....    | .1129 |
| Minimum .....    | .1116 |
|                  | <hr/> |
| Difference ..... | .0013 |

*Root Diam.*

|                  |       |
|------------------|-------|
| Maximum .....    | .0995 |
| Minimum .....    | .0968 |
|                  | <hr/> |
| Difference ..... | .0027 |

Now if we had the largest allowable tap and the smallest allowable screw, we would have a screw of diameter .121 in. in a tapped hole .1301 in, whose root diam-

eter is .1015 (controlled by drill size 38, as per table). Not much chance for shake there, and if the tap was made in Maine and the screw in California, this is the worst condition we could have.

The same idea has been followed by the Automobile men (Society of Automotive Engineers) in fractional sizes from  $\frac{1}{4}$  in. up (S. A. E. standard), and so we can run the whole gamut of screw and bolt sizes and still stick to a recognized standard form of thread and pitch.

You will ask, "Where does all this help us and how?" Suppose we all own the same kind of taps and dies (a standard of our own). Now if Bill designs and builds a nice little model he wishes to have us all know about it and straightway tells our editor. In due time said design appears in the magazine and Bill can send us his castings, together with bolts and nuts that we can use without buying a few extra taps for the purpose. (I feel very strongly about this, Mr. Editor, having just invested some "hard earned" in taps to utilize a few special fittings.)

Of course, we all agree on the beauties and advantages of the scheme, so what shall we use as the standard? There is the S. A. E. from  $\frac{1}{4}$  in. up, conflicting with screw sizes from 16 to 30 (which are rarely used). Below  $\frac{1}{4}$  in., where we model men mostly work, we can descend by approximately  $\frac{1}{64}$  in. steps by A. S. M. E. screw sizes to 14 to 0. Taps, dies, screws, bolts and nuts of these standards can be bought at almost any hardware store or garage and the difference in diameter of two sizes are so close as to eliminate all screw threading on the lathe. So then let us tabulate from recognized engineering standards, the following compound standard, sufficient to cover all our wants, which I will call:

*The Standard Thread*

| Size                   | Threads<br>per inch |
|------------------------|---------------------|
| A. S. M. E. 0.....     | 80                  |
| “ 1.....               | 72                  |
| “ 2.....               | 64                  |
| “ 3.....               | 56                  |
| “ 4.....               | 48                  |
| “ 5.....               | 44                  |
| “ 6.....               | 40                  |
| “ 7.....               | 36                  |
| “ 8.....               | 36                  |
| “ 9.....               | 32                  |
| “ 10.....              | 30                  |
| “ 12.....              | 28                  |
| “ 14.....              | 24                  |
| “ $\frac{1}{4}$ .....  | 28                  |
| “ $\frac{5}{16}$ ..... | 24                  |
| “ $\frac{3}{8}$ .....  | 24                  |
| “ $\frac{7}{16}$ ..... | 20                  |
| “ $\frac{1}{2}$ .....  | 20                  |
| “ $\frac{9}{16}$ ..... | 18                  |
| “ $\frac{5}{8}$ .....  | 18                  |

With this suggested disposal of the entire thread question, we can start our collective mechanical lives on a true engineering basis and leave our agile minds free for more important work.

The table in Fig. 308 will prove useful on many occa-

TABLE OF ALLOWANCES FOR DIFFERENT FITS

| Diameter, Inches    | Running Fits        | Push Fits            |
|---------------------|---------------------|----------------------|
| Up to $\frac{1}{2}$ | -0.00075 to -0.0015 | -0.00025 to -0.00075 |
| $\frac{1}{2}$ to 1  | -0.001 to -0.002    | -0.0005 to -0.001    |
| 1 to 2              | -0.0015 to -0.0025  | -0.0005 to -0.0015   |
| 2 to 3              | -0.0015 to -0.003   | -0.0005 to -0.0015   |
| 3 to 4              | -0.002 to -0.0035   | -0.00075 to -0.002   |
| 4 to 5              | -0.0025 to -0.004   | -0.00075 to -0.002   |
| 5 to 6              | -0.0025 to -0.0045  | -0.00075 to -0.002   |
| Diameter, Inches    | Driving Fits        | Forced Fits          |
| Up to $\frac{1}{2}$ | +0.0004 to +0.0005  | +0.0005 to +0.001    |
| $\frac{1}{2}$ to 1  | +0.0005 to +0.001   | +0.001 to +0.003     |
| 1 to 2              | +0.00075 to +0.002  | +0.002 to +0.004     |
| 2 to 3              | +0.0015 to +0.003   | +0.003 to +0.006     |
| 3 to 4              | +0.002 to +0.004    | +0.005 to +0.008     |
| 4 to 5              | +0.002 to +0.0045   | +0.006 to +0.010     |
| 5 to 6              | +0.003 to +0.005    | +0.008 to +0.012     |

Fig. 307

sions. It gives the percentages of the metals used to make the common alloys. By the use of this information, the mechanic can make all of his alloys with a low-melting point in the little smelting furnace described in Chapter IX.

The grinding wheel grade list below will be found very helpful in choosing a wheel for a certain purpose. The list of the two leading abrasive manufacturers is included owing to the fact that their wheels are on sale at all large hardware stores.

The second-grade scale is entirely different from the one just given and it has absolutely no relation to the first, being that of another manufacturer.

The table of decimal equivalents given in Fig. 309 will be found extremely useful when making measurements with the micrometer. It gives the decimal equivalents



NORTON WHEELS

(Crystolon and Alundum)

|                |        |             |
|----------------|--------|-------------|
| E              | .....  | Soft        |
| F              |        |             |
| G              |        |             |
| H              |        |             |
| I              | .....  | Medium soft |
| J              |        |             |
| K              |        |             |
| L              |        |             |
| M              | .....  | Medium      |
| N              |        |             |
| O              |        |             |
| P              |        |             |
| Medium hard    | ..Q    |             |
|                | R      |             |
|                | S      |             |
|                | T      |             |
| Hard           | .....U |             |
|                | V      |             |
|                | W      |             |
|                | X      |             |
|                | Y      |             |
| Extremely hard | .....Z |             |

for all of the common fractions from one-eighth to sixty-three sixty-fourths.

Another valuable table is given in Fig. 307. This gives

(Carborundum and Aloxite)

|                 |        |
|-----------------|--------|
| Very hard       | .....D |
|                 | E      |
|                 | F      |
| Hard            | .....G |
|                 | G      |
|                 | H      |
|                 | H      |
|                 | I      |
| Medium hard     | .....I |
|                 | J      |
|                 | K      |
|                 | L      |
| Medium          | .....M |
|                 | N      |
|                 | O      |
| Medium soft     | .....P |
|                 | R      |
|                 | S      |
| Soft            | .....T |
|                 | U      |
|                 | V      |
| Very soft       | .....W |
|                 | X      |
|                 | Y      |
| Very, very soft | .....Z |

the correct allowances for running, driving, push and forced fits. It will be understood that to arrive at these measurements it requires great skill and very careful ma-

PERCENTAGES OF METALS USED IN DIFFERENT ALLOYS

|                              | Antimony | Bismuth | Copper | Iron | Lead | Nickel | Tin  | Zinc |
|------------------------------|----------|---------|--------|------|------|--------|------|------|
| Brass (Common).....          |          |         | 61.6   |      | 2.9  |        | 0.2  | 35.3 |
| Brass (For Rolling).....     |          |         | 32     |      |      |        | 1.5  | 10   |
| Brass Castings (Common)..... |          |         | 20     |      |      |        | 2.5  | 1.25 |
| Gun Metal.....               |          |         | 8      |      |      |        | 1    |      |
| Bronze.....                  |          |         | 91.7   |      | 1.37 |        | 1.7  | 5.53 |
| German Silver.....           |          |         | 2      | 6.5  |      | 7.9    |      | 6.3  |
| Britannia Metal.....         | 50       | 25      |        |      |      |        | 25   |      |
| Chinese White Copper.....    |          |         | 20.2   |      |      | 15.8   | 1.3  | 12.7 |
| Pattern Letters.....         | 15       | 15      |        |      | 70   |        |      |      |
| Bell Metal.....              |          |         | 4      |      |      |        | 1    |      |
| Chinese Gongs.....           |          |         | 40.5   |      |      |        | 9.2  | 3    |
| White Metal.....             | 28.4     |         | 3.7    |      |      |        | 14.2 | 1.7  |
| Spelter.....                 |          |         | 1      |      |      |        |      |      |
| Type Metal.....              |          |         |        |      | 3.7  |        |      |      |

Fig. 308

nipulation of the tools. Where the allowance is extremely small, lapping should be resorted to.

The following mathematical helps may prove useful at times, especially if one's memory of school problems is growing dim and it generally does unless work of this nature is done occasionally.

To find the circumference of a circle, multiply the diameter by 3.1416.

To find the diameter of a circle, multiply the circumference by .31831.

To find the area of a circle, multiply the square of the diameter by .7854.

To find the surface of a sphere, multiply the square of the diameter by .31416.

To find the number of cubic inches (volume) in a sphere, multiply the cube of the diameter by .5236.

The radius of a circle x 6.283185 = the circumference.

The square of the diameter of a circle x .7854 = the area.

The square of the circumference of a circle x .07958.

Half the circumference of a circle x half its diameter = the area.

TABLE OF DECIMAL EQUIVALENTS

|                       |                          |                          |                           |                           |
|-----------------------|--------------------------|--------------------------|---------------------------|---------------------------|
| <b>8ths.</b>          | $\frac{9}{16} = 5625$    | $\frac{17}{32} = .53125$ | $\frac{9}{64} = 140625$   | $\frac{37}{64} = .578125$ |
| $\frac{1}{8} = 125$   | $\frac{11}{16} = 6875$   | $\frac{19}{32} = .59375$ | $\frac{11}{64} = 171875$  | $\frac{39}{64} = .609375$ |
| $\frac{1}{4} = .250$  | $\frac{13}{16} = .8125$  | $\frac{21}{32} = .65625$ | $\frac{13}{64} = .203125$ | $\frac{41}{64} = .640625$ |
| $\frac{3}{8} = .375$  | $\frac{15}{16} = 9375$   | $\frac{23}{32} = 71875$  | $\frac{15}{64} = .234375$ | $\frac{43}{64} = .671875$ |
| $\frac{1}{2} = .500$  | <b>32ds.</b>             | $\frac{25}{32} = 78125$  | $\frac{17}{64} = .265625$ | $\frac{45}{64} = .703125$ |
| $\frac{5}{8} = .625$  |                          | $\frac{27}{32} = .84375$ | $\frac{19}{64} = .296875$ | $\frac{47}{64} = 734375$  |
| $\frac{3}{4} = 750$   |                          | $\frac{29}{32} = .90625$ | $\frac{21}{64} = .328125$ | $\frac{49}{64} = 765625$  |
| $\frac{7}{8} = 875$   |                          | $\frac{31}{32} = 96875$  | $\frac{23}{64} = .359375$ | $\frac{51}{64} = 796875$  |
|                       |                          | $\frac{5}{32} = .15625$  | $\frac{25}{64} = .390625$ | $\frac{53}{64} = .828125$ |
| <b>16ths.</b>         | $\frac{7}{32} = 21875$   | <b>64ths.</b>            | $\frac{27}{64} = .421875$ | $\frac{55}{64} = .859375$ |
| $\frac{1}{16} = 0625$ | $\frac{9}{32} = .28125$  | $\frac{1}{64} = .015625$ | $\frac{29}{64} = .453125$ | $\frac{57}{64} = .890625$ |
| $\frac{3}{16} = 1875$ | $\frac{11}{32} = .34375$ | $\frac{3}{64} = .046875$ | $\frac{31}{64} = .484375$ | $\frac{59}{64} = .921875$ |
| $\frac{5}{16} = 3125$ | $\frac{13}{32} = 40625$  | $\frac{5}{64} = .078125$ | $\frac{33}{64} = .515625$ | $\frac{61}{64} = .953125$ |
| $\frac{7}{16} = 4375$ | $\frac{15}{32} = 46875$  | $\frac{7}{64} = 109375$  | $\frac{35}{64} = 546875$  | $\frac{63}{64} = .984375$ |

Fig. 309

The circumference of a circle x .15955 = the radius.

The square root of the area of a circle x .56419 = the radius.

The square root of the area of a circle x 1.12838 = the diameter.

## INDEX

### A

Abrasive wheels, 214.  
Action of force on lever, 22.  
Adjustable wrench, 81.  
Adjusting die, 77.  
Angle plate, 171.  
Angle plate, mounting of, 171.  
Anvil, 82.  
Arboring tool, 213.  
Attachment, drilling for lathe, 203.  
Attachment, overhead for lathe, 205.

### B

Bench lathe, 128-153.  
Bevel gears, 42.  
Board, moulding, 231.  
Bond, 217.  
Boring, 176.  
Boring bar, 175.  
Boring bar, special, 276.  
Boring cylinder, 167.  
Boring casting for drill press, 277.  
Boring tools, 177.  
Boring tools, grinding of, 177.  
Bottoming drill, 122.  
Bottoming tap, 74.  
Box, core, 239.  
Brass hammer, 84.  
Brass melting furnace, 242.  
Brazing, 255.  
Brick for tinning, 257.

Buffing, 228.  
Built-up crankshaft, 183.

### C

Calipers, inside, 91.  
Calipers, outside, 88.  
Calipers, shoulder, 92.  
Calipers, vernier, 97.  
Case hardening, 252.  
Casting, explanation, 229.  
Castings, shrinkage of, 234.  
Center drill, lathe, 130.  
Center, lathe, 129.  
Center of gravity, 32.  
Center punch, 66.  
Center rest, for lathe, 145.  
Chart for machine screws, 306.  
Chemical energy, 14.  
Chisels, 69.  
Chuck, drill, 112.  
Chuck, lathe, 135.  
Circular pitch, 39.  
Clamps, 84.  
Classification of files, 50.  
Coefficient of cubical expansion, 46.  
Coefficient of linear expansion, 45.  
Compound lever, 21.  
Cone pulley, lathe, 143.  
Conservation of energy, 15.  
Construction of boring bar, 175.  
Construction of D-bit, 197.  
Cope, 231.

- Copper, heating, 258.  
 Core box, 238.  
 Core box, use of 239.  
 Core prints, 236.  
 Countershaft, 151.  
 Countersink, 122.  
 Counter weight, 170.  
 Crankshaft, built-up, 183.  
 Crankshaft, double throw, 182.  
 Crankshafts, 179.  
 Crown gears, 42.  
 Cubical expansion, coefficient of, 46.  
 Cutter, fly, 121.  
 Cutting inside threads, 195.  
 Cutting keyways, 202.  
 Cutting outside threads, 194.  
 Cutting slots, 57.  
 Cutting threads, 193.  
 Cylinder, boring, 167.
- D
- D-bit, 197.  
 D-bit, construction of, 197.  
 D-bit reamer, 210.  
 D-bit tool holder, 199.  
 Decalescence, 246.  
 Decimal equivalents of fraction, 313.  
 Definition of energy, 14.  
 Definition of matter, 13.  
 Depth gauge, 99.  
 Depth gauge, home-made, 103.  
 Depth gauge, micrometer, 99.  
 Diameter, pitch, 38.  
 Die, 76.  
 Die stock, 76.  
 Dies, pipe, 79.  
 Different kinds of energy, 14.  
 Different lines used on drawings, 304.  
 Dividers, use of, 106.  
 Dog, lathe, 129.  
 Double-cut files, 50.
- Double throw crankshaft, 182.  
 Drag, 231.  
 Draught of patterns, 234.  
 Drawings, reading of, 301.  
 Drift, 124.  
 Drill, bottoming, 122.  
 Drill chuck, 112.  
 Drill for brass, 116.  
 Drill for iron, 116.  
 Drill lead hole, 117.  
 Drill, number, 110.  
 Drill pad, 137.  
 Drill parts, 108.  
 Drill press, 112.  
 Drill press casting, boring of, 277.  
 Drill press, construction of, 267.  
 Drills, 108.  
 Drills, grinding of, 108.  
 Drilling attachment for lathe, 203.  
 Drilling gun barrel, 200.  
 Driving fits, 310.  
 Driving grinding head, 216.  
 Driving punch, 67.
- E
- Eccentric, turning of, 173.  
 Elbow turning, 169.  
 End plates, 181.  
 Energy, 14.  
 Energy, chemical, 14.  
 Energy, conservation of, 14.  
 Energy, different kinds of, 14.  
 Energy, kinetic, 14.  
 Energy, transformation of, 14.  
 Equivalents, decimal of fractions, 313.
- F
- Face plate, 168.  
 Face plate, lathe, 133.

Fast filing, 54.  
 Files, 49.  
 Fillets, 236.  
 Finding center of gravity, 33.  
 First class lever, 18.  
 Fits, driving, 310.  
 Fits, pushed, 310.  
 Fits, running, 310.  
 Fly cutter, 121.  
 Fly wheel, turning of, 173.  
 Foot-pound, 15.  
 Force, 14.  
 Force and reaction, 30.  
 Forced fits, 310.  
 Forces, parallel, 17.  
 Forces, resultant, 17.  
 Friction, 29.  
 Friction, kinetic, 29.  
 Furnace for brass melting, 242.

## G

Gasolene hardening furnace for steel, 249.  
 Gasolene torch, operation of, 259.  
 Gauge, depth, 99.  
 Gauge, surface, 100.  
 Gauge, thread, 195.  
 Gear bevel, 42.  
 Gear calculations, 43.  
 Gear index plate for lathe, 191.  
 Gears, 37.  
 Gears, crown, 42.  
 Gears, for lathe, 190.  
 Gears, meshing of, 40.  
 Gears, speed of, 38.  
 Gears, worm, 40.  
 Gearing, principle of, 37.  
 Grade, 217.  
 Gravity, 31.  
 Gravity, center of, 33.  
 Grinder, power, 221.  
 Grinding, 214.  
 Grinding boring tools, 177.

Grinding drills, 108.  
 Grinding head, 215.  
 Grinding head, construction of, 294.  
 Grinding head, driving of, 216.  
 Grinding lathe tools, 139.  
 Grit, 217.  
 Gun barrel, drilling of, 200.

## H

Hack saw, 64.  
 Hammer, brass, 84.  
 Hammers, 48.  
 Hand drill, 112.  
 Hand grinder, 220.  
 Hand lathe tools, 132.  
 Hard soldering, 262.  
 Hardening, case, 252.  
 Hardening furnace, gasolene, for steel, 249.  
 Heating copper, 258.  
 Home-made depth gauge, 103.  
 Home-made surface gauge, 102.  
 Horse-power, 15.

## I

Inclined planes, 26.  
 Inertia, 34.  
 Inertia apparatus, 34.  
 Inside calipers, 91.

## J

Jack, 28.  
 Jaws of vise, 62.  
 Jeweller's saw, 65.

## K

Keyways, cutting of, 202.

Keyway scale, 104.  
 Kinetic energy, 14.  
 Kinetic friction, 29.

## L

Lapp board, 224.  
 Lapp grinder, for lathe, 223.  
 Lapping, 227.  
 Lathe, bench, 128, 153.  
 Lathe, centers, 129.  
 Lathe, center rest, 145.  
 Lathe centering drill, 130.  
 Lathe chuck, 135.  
 Lathe, cone pulley, 143.  
 Lathe, dog, 129.  
 Lathe face plate, 133.  
 Lathe gear, index plate, 191.  
 Lathe gears, 190.  
 Lathe gears, mounting of, 190.  
 Lathe hand tools, 132.  
 Lathe lapp grinder, 223.  
 Lathe, large, 142.  
 Lathe milling attachment, 207.  
 Lathe, mounting of, 152.  
 Lathe overhead attachment, 205.  
 Lathe swing, 147.  
 Lathe tail stock, 143.  
 Lathe tools, grinding of, 139.  
 Lathe tools, metal turning, 138.  
 Lathe work, 155.  
 Layout of shop, 148.  
 Lead, 35.  
 Lead hole for drill, 117.  
 Lead screw, lathe, 144.  
 Letter punch, 84.  
 Lever, 18.  
 Lever, first class, 18.  
 Lever, problems of the, 20.  
 Lever, second class, 19.  
 Lever, the compound, 21.  
 Lever, third class, 19.

Linear expansion, coefficient of, 46.

## M

Machine screw chart, 306.  
 Machining of angle plate, 171.  
 Machinist's scale, 86.  
 Mandrel, wooden, use of, 162.  
 Marking, 105.  
 Meshing of gears, 40.  
 Metal turning lathe tools, 138.  
 Micrometer, 93.  
 Micrometer depth gauge, 99.  
 Micrometer, how to read, 93.  
 Milling attachment for lathe, 207.  
 Milling cutters, use of in lathe, 209.  
 Momentum, 34.  
 Moulding board, 231.  
 Mounting angle plate, 171.  
 Mounting lathe, 152.  
 Mounting lathe gears, 190.

## N

Negative rake, 134.  
 Non-adjustable wrench, 81.  
 Number drills, 110.

## O

Outside calipers, 88.

## P

Parallel forces, 17.  
 Parallel jaw plier, 80.  
 Pattern making, 229.  
 Patterns, draught of, 234.  
 Patterns for drill press, construction of, 267.  
 Patterns, split, 232.  
 Pickle for silver soldering, 263.



Pins, thrust, 186.  
 Pipe dies, 79.  
 Pitch, 35.  
 Pitch, circular, 39.  
 Pitch, diameter, 39.  
 Planes, inclined, 26.  
 Plate, angle, 171.  
 Plate, surface, 101.  
 Pliers, 80.  
 Pliers, parallel jaw, 80.  
 Plug tap, 74.  
 Polishing, 228.  
 Positive rake, 134.  
 Power, 14.  
 Power grinder, 221.  
 Principle of gearing, 37.  
 Prints, core, 236.  
 Problems of the lever, 20.  
 Proper method of holding file,  
     51.  
 Protractor, 104.  
 Pulleys, 24.  
 Pulleys, systems of, 25.  
 Pulleys, turning of, 286.  
 Punch, center, 66.  
 Punch, driving, 67.  
 Punch, letter, 84.  
 Pushed fits, 310.

R

Rack and pinion, 41.  
 Rake, negative, 134.  
 Rake, positive, 134.  
 Reading drawings, 301.  
 Reading micrometer, 93.  
 Reamer, 125.  
 Reamer, sharpening of, 126.  
 Reamer, special for D-bit, 210.  
 Reaming drill press casting,  
     279.  
 Reaming on lathe, 165.  
 Recalescence, 246.  
 Relation of lead and pitch, 35.  
 Resultant forces, 17.

Rivets, 68.  
 Rivetting, 68.  
 Running-down cutter, 213.  
 Running fits, 310.

## S

Scale, keyway, 104.  
 Scale, machinist's, 86.  
 Scraper, for soldering, 256.  
 Scrapers, 59.  
 Scraping, 59.  
 Screw, 28.  
 Screw drivers, 63.  
 Screw, lead for lathe, 144.  
 Second class lever, 19.  
 Shaft hangers, 150.  
 Sharpening reamer, 126.  
 Shop layout, 148.  
 Shoulder calipers, 92.  
 Shrinkage of castings, 234.  
 Silver soldering, 262.  
 Silver soldering, pickle for,  
     263.  
 Single-cut files, 50.  
 Slide rest, 137.  
 Slots, cutting, 57.  
 Soft soldering, 256.  
 Soldering, 255.  
 Soldering copper, tinning of,  
     256.  
 Soldering, hard, 262.  
 Soldering, silver, 262.  
 Soldering, soft, 256.  
 Special boring bar, 276.  
 Speed of gears, 38.  
 Split patterns, 232.  
 Square, 87.  
 Standard V-thread, 36.  
 Static friction, 29.  
 Steel, tempering, 245.  
 Stress table for brass, bronze  
     and steel, 43.  
 Surface gauge, 100.

Surface gauge, home-made, 102.  
 Surface plate, 101.  
 Swing of lathe, 147.  
 Systems of pulleys, 25.

## T

Tail stock, lathe, 143.  
 Tap, plug, 74.  
 Tap wrench, 73.  
 Taps, 71.  
 Taps, use of, 72.  
 Taper reamer, 125.  
 Taper top, 74.  
 Tempering steel, 245.  
 Template, 131.  
 Third class lever, 19.  
 Thread cutting, 193.  
 Thread, cutting outside, 194.  
 Thread cutting tool, 193.  
 Thread gauge, 195.  
 Thread tool gauge, 193.  
 Thread, U. S. Standard, 36.  
 Thread, V. Standard, 36.  
 Thread, Whitworth, 36.  
 Thrust pins, 186.  
 Tinning brick, 257.  
 Tinning soldering copper, 256.  
 Tool, arboring, 213.  
 Tool gauge, thread, 193.  
 Tool holder for D-bit, 199.  
 Tool, thread cutting, 193.  
 Tools, boring, 177.  
 Top, taper, 74.  
 Transformation of energy, 14.  
 Turning crankshafts, 179.  
 Turning cylinder, 161.  
 Turning eccentric, 173.  
 Turning elbow, 169.

Turning fly wheel, 173.  
 Turning pulleys, 287.

## U

Use of anvil, 82.  
 Use of chisels, 69.  
 Use of die, 76.  
 Use of dividers, 106.  
 Use of end plates, 181.  
 Use of face plate, 169.  
 Use of hack saw, 64.  
 Use of half-round files, 55.  
 Use of milling cutters in lathe, 209.  
 Use of scale, 86.  
 Use of scrapers, 59.  
 Use of small file, 53.  
 Use of taps, 71.  
 U. S. Standard Thread, 36.

## V

V-blocks, 118.  
 Velocity of matter, 16.  
 Vernier calipers, 97.  
 Vise, 61.  
 Vise, jaws of, 62.  
 Vitrified abrasive wheels, 217.

## W

Wedge, 27.  
 Wheel, abrasive, vitrified, 217.  
 Whitworth thread, 36.  
 Wooden mandrel, use of, 162.  
 Work, 14.  
 Worm gears, 40.  
 Wrench, 81.  
 Wrench, tap, 73.

1920  
REVISED  
**CATALOGUE**

*of the Latest and Best*

**Practical and Mechanical Books**

Including Automobile and Aviation Books



**PRACTICAL BOOKS FOR PRACTICAL MEN**

Each Book in this Catalogue is written by an  
Expert and is written so you can understand it

---

PUBLISHED BY

**THE NORMAN W. HENLEY PUBLISHING CO.**

2 West 45th Street, New York, U. S. A.

*Established 1890*

 Any Book in this Catalogue sent prepaid on receipt of price

# INDEX

|                                    | PAGE                   |                              | PAGE               |
|------------------------------------|------------------------|------------------------------|--------------------|
| Air Brakes.....                    | 26, 29                 | Machinist Books.....         | 29, 30, 31, 32, 33 |
| Arithmetic.....                    | 16, 30, 40             | Manual Training.....         | 34                 |
| Automobile Books.....              | 3, 4, 5, 6             | Marine Engineering.....      | 33                 |
| Automobile Charts.....             | 6, 7                   | Marine Gasoline Engines..... | 23                 |
| Aviation.....                      | 6, 7, 8                | Mechanical Drawing.....      | 16                 |
| Aviation Chart.....                | 6                      | Mechanical Movements.....    | 31                 |
| Bevel Gear.....                    | 24                     | Metal Work.....              | 14, 15             |
| Brazing.....                       | 8                      | Mining.....                  | 34                 |
| Cams.....                          | 24                     | Model Making.....            | 32                 |
| Carburetors.....                   | 5                      | Motor Boats.....             | 35                 |
| Change Gear.....                   | 24                     | Motorcycles.....             | 6                  |
| Charts.....                        | 6, 7, 9                | Patents.....                 | 25                 |
| Coal.....                          | 22                     | Pattern Making.....          | 34                 |
| Coke.....                          | 11                     | Perfumery.....               | 35                 |
| Combustion.....                    | 27                     | Perspective.....             | 15                 |
| Compressed Air.....                | 11                     | Plumbing.....                | 36, 37             |
| Concrete.....                      | 11, 12, 13, 14         | Producer Gas.....            | 23                 |
| Cosmetics.....                     | 35                     | Punches.....                 | 15                 |
| Dictionary.....                    | 14                     | Radio.....                   | 20                 |
| Dies.....                          | 14, 15                 | Railroad Accidents.....      | 28                 |
| Drawing.....                       | 15, 16, 36             | Railroad Charts.....         | 10                 |
| Drop Forging.....                  | 15                     | Recipe Book.....             | 37                 |
| Dynamo Building.....               | 16                     | Refrigeration.....           | 24                 |
| Electric Bells.....                | 20                     | Rubber Stamps.....           | 39                 |
| Electric Switchboards.....         | 17, 19                 | Saw Filing.....              | 38                 |
| Electric Toy Making.....           | 17                     | Saws, Management of.....     | 38                 |
| Electric Wiring.....               | 18, 19                 | Sheet Metal Works.....       | 14, 15             |
| Electricity.....                   | 16, 17, 18, 19, 20, 21 | Shop Tools.....              | 32                 |
| Electroplating.....                | 21                     | Sketching Paper.....         | 16                 |
| "Everyday Engineering".....        | 30                     | Soldering.....               | 8                  |
| Factory Management.....            | 21                     | Steam Engineering.....       | 39, 40             |
| Ford Automobile.....               | 3                      | Steam Heating.....           | 40, 41             |
| Ford Trouble Chart.....            | 10                     | Steel.....                   | 41, 42             |
| Formulas and Recipes.....          | 37                     | Storage Batteries.....       | 21                 |
| Fuel.....                          | 22                     | Submarine Chart.....         | 10                 |
| Gas Engine Construction.....       | 23                     | Switch Boards.....           | 17, 19             |
| Gas Engines.....                   | 22, 23                 | Tapers.....                  | 26                 |
| Gas Tractor.....                   | 42                     | Telegraphy, Wireless.....    | 19                 |
| Gearing and Cams.....              | 24                     | Telephone.....               | 19                 |
| Heating.....                       | 40                     | Thread Cutting.....          | 30                 |
| High Frequency Apparatus.....      | 20                     | Tool Making.....             | 29                 |
| Horse Power Chart.....             | 39                     | Toy Making.....              | 17                 |
| Hot Water Heating.....             | 40, 41                 | Tractive Power Chart.....    | 10                 |
| House Wiring.....                  | 18                     | Tractor, Gas.....            | 42                 |
| Hydraulics.....                    | 24                     | Train Rules.....             | 28                 |
| Ice.....                           | 24                     | Turbines.....                | 42                 |
| Interchangeable Manufacturing..... | 29                     | Vacuum Heating.....          | 41                 |
| Inventions.....                    | 25                     | Valve Setting.....           | 27                 |
| Knots.....                         | 25                     | Ventilation.....             | 40                 |
| Lathe Work.....                    | 25, 26                 | Walschaert Valve Gear.....   | 29                 |
| Link Motions.....                  | 27                     | Waterproofing.....           | 14                 |
| Liquid Air.....                    | 26                     | Welding.....                 | 5                  |
| Locomotive Boilers.....            | 27                     | Wireless Telegraphy.....     | 19, 20             |
| Locomotive Breakdowns.....         | 27                     | Wiring.....                  | 18, 19             |
| Locomotive Engineering.....        | 26, 27, 28, 29         | Wiring Diagrams.....         | 17                 |

Any of these books promptly sent prepaid to any address in the world on receipt of price.

How to remit.—By Postal Money Order, Express Money Order, Bank Draft or Registered Letter.

**AUTOMOBILES AND MOTORCYCLES**

**THE MODERN GASOLINE AUTOMOBILE—ITS DESIGN, CONSTRUCTION, MAINTENANCE AND REPAIR.** By VICTOR W. PAGÉ, M.E.

The latest and most complete treatise on the Gasoline Automobile ever issued. Written in simple language by a recognized authority, familiar with every branch of the automobile industry. Free from technical terms. Everything is explained so simply that anyone of average intelligence may gain a comprehensive knowledge of the gasoline automobile. The information is up-to-date and includes, in addition to an exposition of principles of construction and description of all types of automobiles and their components, valuable money-saving hints on the care and operation of motor-cars propelled by internal combustion engines. Among some of the subjects treated might be mentioned: Torpedo and other symmetrical body forms designed to reduce air resistance; sleeve valve, rotary valve and other types of silent motors; increasing tendency to favor worm-gear power-transmission; universal application of magneto ignition; development of automobile electric-lighting systems; block motors; under-slung chassis; application of practical self-starters; long stroke and offset cylinder motors; latest automatic lubrication systems; silent chains for valve operation and change-speed gearing; the use of front wheel brakes and many other detail refinements. By a careful study of the pages of this book one can gain practical knowledge of automobile construction that will save time, money and worry. The book tells you just what to do, how and when to do it. Nothing has been omitted, no detail has been slighted. Every part of the automobile, its equipment, accessories, tools, supplies, spare parts necessary, etc., have been discussed comprehensively. If you are or intend to become a motorist, or are in any way interested in the modern Gasoline Automobile, this is a book you cannot afford to be without. Over 1,000 pages—and more than 1,000 new and specially made detail illustrations, as well as many full-page and double-page plates, showing all parts of the automobile. Including 12 large folding plates. 1920 Edition. Price . . . . . \$4.00

**WHAT IS SAID OF THIS BOOK:**

"It is the best book on the Automobile seen up to date."—J. H. Pile, Associate Editor *Automobile Trade Journal*.

"Every Automobile Owner has use for a book of this character."—*The Tradesman*.

"This book is superior to any treatise heretofore published on the subject."—*The Inventive Age*.

"We know of no other volume that is so complete in all its departments, and in which the wide field of automobile construction with its mechanical intricacies is so plainly handled, both in the text and in the matter of illustrations."—*The Motorist*.

"The book is very thorough, a careful examination failing to disclose any point in connection with the automobile, its care and repair, to have been overlooked."—*Iron Age*.

"Mr. Pagé has done a great work, and benefit to the Automobile Field."—W. C. Hasford, Mgr. Y. M. C. A. Automobile School, Boston, Mass.

"It is just the kind of a book a motorist needs if he wants to understand his car."—*American Thresherman*.

**THE MODEL T FORD CAR, ITS CONSTRUCTION, OPERATION AND REPAIR, INCLUDING THE FORD FARM TRACTOR.** By VICTOR W. PAGÉ, M.E.

This is a complete instruction book. All parts of the Ford Model T Car are described and illustrated; the construction is fully described and operating principles made clear to everyone. Every Ford owner needs this practical book. You don't have to guess about the construction or where the trouble is, as it shows how to take all parts apart and how to locate and fix all faults. The writer, Mr. Pagé, has operated a Ford car for four years and writes from actual knowledge. Among the contents are: 1. The Ford Car. Its Parts and Their Functions. 2. The Engine and Auxiliary Groups. How the Engine Works—The Fuel Supply System—The Carburetor—Making the Ignition Spark—Cooling and Lubrication. 3. Details of Chassis. Change Speed Gear—Power Transmission—Differential Gear Action—Steering Gear—Front Axle—Frame and Springs—Brakes. 4. How to Drive and Care for the Ford. The Control System Explained—Starting the Motor—Driving the Car—Locating Roadside Troubles—Tire Repairs—Oiling the Chassis—Winter Care of Car. 5. Systematic Location of Troubles and Remedies. Faults in Engine—Faults in Carburetor

## CATALOGUE OF GOOD, PRACTICAL BOOKS

—Ignition Troubles—Cooling and Lubrication System Defects—Adjustment of Transmission Gear—General Chassis Repairs. The Ford Tractor and Tractor conversion sets and Genuine Fordson Tractor Operation and Repair—F. A. Starting and Lighting System. 153 illustrations. 410 pages. Two large folding plates. Price . . . . . \$2.00

### **AUTOMOBILE REPAIRING MADE EASY.** By VICTOR W. PAGÉ, M.E.

A comprehensive, practical exposition of every phase of modern automobile repairing practice. Outlines every process incidental to motor car restoration. Gives plans for workshop construction, suggestions for equipment, power needed, machinery and tools necessary to carry on the business successfully. Tells how to overhaul and repair all parts of all automobiles. Everything is explained so simply that motorists and students can acquire a full working knowledge of automobile repairing. This work starts with the engine, then considers carburetion, ignition, cooling and lubrication systems. The clutch, change speed gearing and transmission system are considered in detail. Contains instructions for repairing all types of axles, steering gears and other chassis parts. Many tables, short cuts in figuring and rules of practice are given for the mechanic. Explains fully valve and magneto timing, "tuning" engines, systematic location of trouble, repair of ball and roller bearings, shop kinks, first aid to injured and a multitude of subjects of interest to all in the garage and repair business.

*This book contains special instructions on electric starting, lighting and ignition systems, tire repairing and rebuilding, autogenous welding, brazing and soldering, heat treatment of steel, latest timing practice, eight and twelve-cylinder motors, etc.* 5¼x8. Cloth. 1056 pages, 1,000 illustrations, 11 folding plates. Price . . . . . \$4.00

#### WHAT IS SAID OF THIS BOOK:

"'Automobile Repairing Made Easy' is the best book on the subject I have ever seen and the only book I ever saw that is of any value in a garage."—Fred Jeffrey, Martinsburg, Neb.

"I wish to thank you for sending me a copy of 'Automobile Repairing Made Easy.' I do not think it could be excelled."—S. W. Gisriel, Director of Instruction, Y. M. C. A., Philadelphia, Pa.

### **QUESTIONS AND ANSWERS RELATING TO MODERN AUTOMOBILE CONSTRUCTION, DRIVING AND REPAIR.** By VICTOR W. PAGÉ, M.E.

A practical self-instructor for students, mechanics and motorists, consisting of thirty-seven lessons in the form of questions and answers, written with special reference to the requirements of the non-technical reader desiring easily understood, explanatory matter relating to all branches of automobiling. The subject-matter is absolutely correct and explained in simple language. If you can't answer all of the following questions, you need this work. The answers to these and nearly 2000 more are to be found in its pages. Give the name of all important parts of an automobile and describe their functions? Describe action of latest types of kerosene carburetors? What is the difference between a "double" ignition system and a "dual" ignition system? Name parts of an induction coil? How are valves timed? What is an electric motor starter and how does it work? What are advantages of worm drive gearing? Name all important types of ball and roller bearings? What is a "three-quarter" floating axle? What is a two-speed axle? What is the Vulcan electric gear shift? Name the causes of lost power in automobiles? Describe all noises due to deranged mechanism and give causes? How can you adjust a carburetor by the color of the exhaust gases? What causes "popping" in the carburetor? What tools and supplies are needed to equip a car? How do you drive various makes of cars? What is a differential lock and where is it used? Name different systems of wire wheel construction, etc., etc. A popular work at a popular price. 5¼x7½. Cloth. 700 pages, 350 illustrations, 3 folding plates. Price . . . . . \$2.50

#### WHAT IS SAID OF THIS BOOK:

"If you own a car—get this book."—*The Glassworker.*

"Mr. Pagé has the faculty of making difficult subjects plain and understandable."—*Bristol Press.*

"We can name no writer better qualified to prepare a book of instruction on automobiles than Mr. Victor W. Pagé."—*Scientific American.*

"The best automobile catechism that has appeared."—*Automobile Topics.*

"There are few men, even with long experience, who will not find this book useful. Great pains have been taken to make it accurate. Special recommendation must be

## CATALOGUE OF GOOD, PRACTICAL BOOKS

---

---

given to the illustrations, which have been made specially for the work. Such excellent books as this greatly assist in fully understanding your automobile."—*Engineering News*.

### MODERN STARTING, LIGHTING AND IGNITION SYSTEMS. By VICTOR W. PAGÉ, M.E.

This practical volume has been written with special reference to the requirements of the non-technical reader desiring easily understood, explanatory matter, relating to all types of automobile ignition, starting and lighting systems. It can be understood by anyone, even without electrical knowledge, because elementary electrical principles are considered before any attempt is made to discuss features of the various systems. These basic principles are clearly stated and illustrated with simple diagrams. *All the leading systems of starting, lighting and ignition have been described and illustrated with the co-operation of the experts employed by the manufacturers.* Wiring diagrams are shown in both technical and non-technical forms. All symbols are fully explained. It is a comprehensive review of modern starting and ignition system practice, and includes a complete exposition of storage battery construction, care and repair. All types of starting motors, generators, magnetos, and all ignition or lighting system units are fully explained. The systems of cars already in use as well as those that are to come in 1920 are considered. *Every person in the automobile business needs this volume.* 5¼x7½. Cloth. 804 pages, 492 illustrations, 3 folding plates. Price . . . \$3.00

### GASOLINE AND KEROSENE CARBURETORS, CONSTRUCTION, INSTALLATION AND ADJUSTMENT. By MAJOR VICTOR W. PAGÉ. A New Up-to-date Book on Modern Carburetion Practice.

This is a simple, comprehensive, and authoritative treatise for practical men explaining all basic principles pertaining to carburetion, showing how liquid fuels are vaporized and turned into gas for operating all types of internal combustion engines intended to operate on vapors of gasoline, kerosene, benzol, and alcohol. All leading types of carburetors are described in detail, special attention being given to the forms devised to use the cheaper fuels such as kerosene. Carburetion troubles, fuel system troubles, carburetor repairs and installation, electric primers and economizers, hot spot manifolds and all modern carburetor developments are considered in a thorough manner. Methods of adjusting all types of carburetors are fully discussed as well as suggestions for securing maximum fuel economy and obtaining highest engine power. This book is invaluable to repairmen, students, and motorists, as it includes the most complete exposition on kerosene carburetors ever published. The drawings showing carburetor construction are made from accurate engineering designs and show all parts of late types of carburetors. 250 pages. 89 illustrations. . . \$2.00

### HOW TO RUN AN AUTOMOBILE. By VICTOR W. PAGÉ.

This treatise gives concise instructions for starting and running all makes of gasoline automobiles, how to care for them, and gives distinctive features of control. Describes every step for shifting gears, controlling engine, etc. Among the chapters contained are: I. Automobile Parts and Their Functions. II. General Starting and Driving Instructions. III. Typical 1919 Control Systems—Care of Automobiles. Thoroughly illustrated. 178 pages. 72 illustrations. Price . . . \$1.50

### THE AUTOMOBILIST'S POCKET COMPANION AND EXPENSE RECORD. By VICTOR W. PAGÉ.

This book is not only valuable as a convenient cost record, but contains much information of value to motorists. Includes a condensed digest of auto laws of all States, a lubrication schedule, hints for care of storage battery, and care of tires, location of road troubles, anti-freezing solutions, horse-power table, driving hints and many useful tables and recipes of interest to all motorists. Not a technical book in any sense of the word, just a collection of practical facts in simple language for the every-day motorist. Convenient pocket size. Price . . . \$1.25

### AUTOMOBILE WELDING WITH THE OXY-ACETYLENE FLAME.<sup>1</sup> By M. KEITH DUNHAM.

Explains in a simple manner apparatus to be used, its care, and how to construct necessary shop equipment. Proceeds then to the actual welding of all automobile

## CATALOGUE OF GOOD, PRACTICAL BOOKS

---

parts, in a manner understandable by every one. Gives principles never to be forgotten. This book is of utmost value, since the perplexing problems arising when metal is heated to a melting point are fully explained and the proper methods to overcome them shown. 167 pages. Fully illustrated. Price. . . . \$1.50

### MOTORCYCLES AND SIDE CARS, THEIR CONSTRUCTION, MANAGEMENT AND REPAIR. By VICTOR W. PAGÉ, M.E.

The only complete work published for the motorcyclist and repairman. Describes fully all leading types of machines, their design, construction, maintenance, operation and repair. This treatise outlines fully the operation of two- and four-cycle power plants and all ignition, carburetion and lubrication systems in detail. Describes all representative types of free engine clutches, variable speed gears and power transmission systems. Gives complete instructions for operating and repairing all types. Considers fully electric self-starting and lighting systems, all types of spring frames and spring forks and shows leading control methods. For those desiring technical information a complete series of tables and many formulæ to assist in designing are included. The work tells how to figure power needed to climb grades, overcome air resistance and attain high speeds. It shows how to select gear ratios for various weights and powers, how to figure braking efficiency required, gives sizes of belts and chains to transmit power safely, and shows how to design sprockets, belt pulleys, etc. This work also includes complete formulæ for figuring horse-power, shows how dynamometer tests are made, defines relative efficiency of air- and water-cooled engines, plain and anti-friction bearings and many other data of a practical, helpful, engineering nature. Remember that you get this information in addition to the practical description and instructions which alone are worth several times the price of the book. 600 pages. 400 specially made illustrations, 4 folding plates. Cloth. Price . . . \$3.00

#### WHAT IS SAID OF THIS BOOK:

"Here is a book that should be in the cycle repairer's kit."—*American Blacksmith*.  
"The best way for any rider to thoroughly understand his machine, is to get a copy of this book; it is worth many times its price."—*Pacific Motorcyclist*.

## AUTOMOBILE, AVIATION AND MOTORCYCLE CHARTS

---

### AVIATION CHART—LOCATION OF AIRPLANE POWER PLANT TROUBLES MADE EASY. By MAJOR VICTOR W. PAGÉ, A.S., S.C.U.S.R.

A large chart outlining all parts of a typical airplane power plant, showing the points where trouble is apt to occur and suggesting remedies for the common defects. Intended especially for aviators and aviation mechanics on school and field duty. Price . . . . . 35 cents

### CHART. GASOLINE ENGINE TROUBLES MADE EASY—A CHART SHOWING SECTIONAL VIEW OF GASOLINE ENGINE. Compiled by VICTOR W. PAGÉ, M.E.

It shows clearly all parts of a typical four-cylinder gasoline engine of the four-cycle type. It outlines distinctly all parts liable to give trouble and also details the derangements apt to interfere with smooth engine operation. Valuable to students, motorists, mechanics, repairmen, garagemen, automobile salesmen, chauffeurs, motorboat owners, motor-truck and tractor drivers, aviators, motorcyclists, and all others who have to do with gasoline power plants. It simplifies location of all engine troubles, and while it will prove invaluable to the novice, it can be used to advantage by the more expert. It should be on the walls of every public and private garage, automobile repair shop, club house or school. It can be carried in the automobile or pocket with ease, and will insure against loss of time when engine trouble manifests itself. This sectional view of engine is a complete review of all motor troubles. It is prepared by a practical motorist for all who motor. More information for the money than ever before offered. No details omitted. Size 25x38 inches. Securely mailed on receipt of . . . . . 35 cents



## CATALOGUE OF GOOD, PRACTICAL BOOKS

### CHART. LOCATION OF FORD ENGINE TROUBLES MADE EASY. Compiled by VICTOR W. PAGÉ, M.E.

This shows clear sectional views depicting all portions of the Ford power plant and auxiliary groups. It outlines clearly all parts of the engine, fuel supply system, ignition group and cooling system, that are apt to give trouble, detailing all derangements that are liable to make an engine lose power, start hard or work irregularly. This chart is valuable to students, owners, and drivers as it simplifies location of all engine faults. Of great advantage as an instructor for the novice, it can be used equally well by the more expert as a work of reference and review. It can be carried in the toolbox or pocket with ease and will save its cost in labor eliminated the first time engine trouble manifests itself. Prepared with special reference to the average man's needs and is a practical review of all motor troubles because it is based on the actual experience of an automobile engineer-mechanic with the mechanism the chart describes. It enables the non-technical owner or operator of a Ford car to locate engine derangements by systematic search, guided by easily recognized symptoms instead of by guesswork. It makes the average owner independent of the roadside repair shop when touring. Must be seen to be appreciated. Size 25x38 inches. Printed on heavy bond paper. Price . . . . . 35 cents

### CHART. LUBRICATION OF THE MOTOR CAR CHASSIS. Compiled by VICTOR W. PAGÉ, M.E.

This chart presents the plan view of a typical six-cylinder chassis of standard design and all parts are clearly indicated that demand oil, also the frequency with which they must be lubricated and the kind of oil to use. A practical chart for all interested in motor-car maintenance. Size 24x38 inches. Price . . . . . 35 cents

### CHART. LOCATION OF CARBURETION TROUBLES MADE EASY. Compiled by VICTOR W. PAGÉ, M.E.

This chart shows all parts of a typical pressure feed fuel supply system and gives causes of trouble, how to locate defects and means of remedying them. Size 24x38 inches. Price . . . . . 35 cents

### CHART. LOCATION OF IGNITION SYSTEM TROUBLES MADE EASY. Compiled by VICTOR W. PAGÉ, M.E.

In this diagram all parts of a typical double ignition system using battery and magneto current are shown, and suggestions are given for readily finding ignition troubles and eliminating them when found. Size 24x38 inches. Price . . . . . 35 cents

### CHART. LOCATION OF COOLING AND LUBRICATION SYSTEM FAULTS. Compiled by VICTOR W. PAGÉ, M.E.

This composite diagram shows a typical automobile power plant using pump circulated water-cooling system and the most popular lubrication method. Gives suggestions for curing all overheating and loss of power faults due to faulty action of the oiling or cooling group. Size 24x38 inches. Price . . . . . 35 cents

### CHART. LOCATION OF STARTING AND LIGHTING SYSTEM FAULTS.

The most complete chart yet devised, showing all parts of the modern automobile starting, lighting and ignition systems, giving instructions for systematic location of all faults in wiring, lamps, motor or generator, switches and all other units. Invaluable to motorists, chauffeurs and repairmen. Size 24x38 inches. Price . 35 cents

### CHART. MOTORCYCLE TROUBLES MADE EASY. Compiled by VICTOR W. PAGÉ, M.E.

A chart showing sectional view of a single-cylinder gasoline engine. This chart simplifies location of all power-plant troubles. A single-cylinder motor is shown for simplicity. It outlines distinctly all parts liable to give trouble and also details the derangements apt to interfere with smooth engine operation. This chart will prove of value to all who have to do with the operation, repair or sale of motorcycles. No details omitted. Size 30x20 inches. Price . . . . . 35 cents

# CATALOGUE OF GOOD, PRACTICAL BOOKS

## AVIATION

### **A B C OF AVIATION.** By MAJOR VICTOR W. PAGÉ.

This book describes the basic principles of aviation, tells how a balloon or dirigible is made and why it floats in the air. Describes how an airplane flies. It shows in detail the different parts of an airplane, what they are and what they do. Describes all types of airplanes and how they differ in construction; as well as detailing the advantages and disadvantages of different types of aircraft. It includes a complete dictionary of aviation terms and clear drawings of leading airplanes. The reader will find simple instructions for unpacking, setting up, and rigging airplanes. A full description of airplane control principles is given and methods of flying are discussed at length.

This book answers every question one can ask about modern aircraft, their construction and operation. A self-educator on aviation without an equal. 275 pages. 130 specially made illustrations with 7 plates. Price . . . . . \$2.50

### **AVIATION ENGINES—DESIGN; CONSTRUCTION; REPAIR.** By MAJOR VICTOR W. PAGÉ, A.S., S.C.U.S.R.

This treatise, written by a recognized authority on all of the practical aspects of internal combustion engine construction, maintenance, and repair, fills the need as no other book does. The matter is logically arranged; all descriptive matter is simply expressed and copiously illustrated, so that anyone can understand airplane engine operation and repair even if without previous mechanical training. This work is invaluable for anyone desiring to become an aviator or aviation mechanic. The latest rotary types, such as the Gnome Monosoupape, and LeRhône, are fully explained, as well as the recently developed Vee and radial types. The subjects of carburetion, ignition, cooling, and lubrication also are covered in a thorough manner. The chapters on repair and maintenance are distinctive and found in no other book on this subject. Not a technical book, but a practical, easily understood work of reference for all interested in aeronautical science. 576 pages. 253 illustrations. Price, net . . . . . \$3.00

### **GLOSSARY OF AVIATION TERMS—ENGLISH-FRENCH; FRENCH-ENGLISH.** By MAJOR VICTOR W. PAGÉ, A.S., S.C.U.S.R., and LIEUT. PAUL MONTARIOL, of the French Flying Corps.

A complete glossary of practically all terms used in aviation, having lists in both French and English with equivalents in either language. Price, net . . . \$1.00

### **AVIATION CHART—LOCATION OF AIRPLANE POWER PLANT TROUBLES MADE EASY.** By MAJOR VICTOR W. PAGÉ, A.S., S.C.U.S.R.

A large chart outlining all parts of a typical airplane power plant, showing the points where trouble is apt to occur and suggesting remedies for the common defects. Intended especially for aviators and aviation mechanics on school and field duty. Price . . . . . 35 cents

## BRAZING AND SOLDERING

### **BRAZING AND SOLDERING.** By JAMES F. HOBART.

The only book that shows you just how to handle any job of brazing or soldering that comes along; it tells you what mixture to use, how to make a furnace if you need one. Full of valuable kinks. The fifth edition of this book has just been published, and to it much new matter and a large number of tested formulae for all kinds of solders and fluxes have been added. Illustrated. . . . . 35 cents

# CATALOGUE OF GOOD, PRACTICAL BOOKS

## CHARTS

### AVIATION CHART—LOCATION OF AIRPLANE POWER PLANT TROUBLES MADE EASY. By MAJOR VICTOR W. PAGÉ, A.S., S.C.U.S.R.

A large chart outlining all parts of a typical airplane power plant, showing the points where trouble is apt to occur and suggesting remedies for the common defects. Intended especially for aviators and aviation mechanics on school and field duty. Price . . . . . 35 cents

### GASOLINE ENGINE TROUBLES MADE EASY—A CHART SHOWING SECTIONAL VIEW OF GASOLINE ENGINE. Compiled by VICTOR W. PAGÉ.

It shows clearly all parts of a typical four-cylinder gasoline engine of the four-cycle type. It outlines distinctly all parts liable to give trouble and also details the derangements apt to interfere with smooth engine operation.

Valuable to students, motorists, mechanics, repairmen, garagemen, automobile salesmen, chauffeurs, motor-boat owners, motor-truck and tractor drivers, aviators, motorcyclists, and all others who have to do with gasoline power plants.

It simplifies location of all engine troubles, and while it will prove invaluable to the novice, it can be used to advantage by the more expert. It should be on the walls of every public and private garage, automobile repair shop, club house or school. It can be carried in the automobile or pocket with ease and will insure against loss of time when engine trouble manifests itself.

This sectional view of engine is a complete review of all motor troubles. It is prepared by a practical motorist for all who motor. No details omitted. Size 25x38 inches. . . . . 35 cents

### LUBRICATION OF THE MOTOR CAR CHASSIS.

This chart presents the plan view of a typical six-cylinder chassis of standard design and all parts are clearly indicated that demand oil, also the frequency with which they must be lubricated and the kind of oil to use. A practical chart for all interested in motor-car maintenance. Size 24x38 inches. Price . . . . . 35 cents

### LOCATION OF CARBURETION TROUBLES MADE EASY.

This chart shows all parts of a typical pressure feed fuel supply system and gives causes of trouble, how to locate defects and means of remedying them. Size 24x38 inches. Price . . . . . 35 cents

### LOCATION OF IGNITION SYSTEM TROUBLES MADE EASY.

In this chart all parts of a typical double ignition system using battery and magneto current are shown and suggestions are given for readily finding ignition troubles and eliminating them when found. Size 24x38 inches. Price . . . . . 35 cents

### LOCATION OF COOLING AND LUBRICATION SYSTEM FAULTS.

This composite chart shows a typical automobile power plant using pump circulated water-cooling system and the most popular lubrication method. Gives suggestions for curing all overheating and loss of power faults due to faulty action of the oiling or cooling group. Size 24x38 inches. Price . . . . . 35 cents

### LOCATION OF STARTING AND LIGHTING SYSTEM FAULTS.

The most complete chart yet devised, showing all parts of the modern automobile starting, lighting and ignition systems, giving instructions for systematic location of all faults in wiring, lamps, motor or generator, switches and all other units. Invaluable to motorists, chauffeurs and repairmen. Size 24x38 inches. Price . . . . . 35 cents

### MOTORCYCLE TROUBLES MADE EASY—A CHART SHOWING SECTIONAL VIEW OF SINGLE-CYLINDER GASOLINE ENGINE. Compiled by VICTOR W. PAGÉ.

This chart simplifies location of all power-plant troubles, and will prove invaluable to all who have to do with the operation, repair or sale of motorcycles. No details omitted. Size 25x38 inches. Price . . . . . 35 cents

# CATALOGUE OF GOOD, PRACTICAL BOOKS

## LOCATION OF FORD ENGINE TROUBLES MADE EASY. Compiled by VICTOR W. PAGÉ, M.E.

This shows clear sectional views depicting all portions of the Ford power plant and auxiliary groups. It outlines clearly all parts of the engine, fuel supply system, ignition group and cooling system, that are apt to give trouble, detailing all derangements that are liable to make an engine lose power, start hard or work irregularly. This chart is valuable to students, owners, and drivers, as it simplifies location of all engine faults. Of great advantage as an instructor for the novice, it can be used equally well by the more expert as a work of reference and review. It can be carried in the toolbox or pocket with ease and will save its cost in labor eliminated the first time engine trouble manifests itself. Prepared with special reference to the average man's needs and is a practical review of all motor troubles because it is based on the actual experience of an automobile engineer-mechanic with the mechanism the chart describes. It enables the non-technical owner or operator of a Ford car to locate engine derangements by systematic search, guided by easily recognized symptoms instead of by guesswork. It makes the average owner independent of the roadside repair shop when touring. Must be seen to be appreciated. Size 25x38 inches. Printed on heavy bond paper. Price . . . . . 35 cents

## MODERN SUBMARINE CHART—WITH 200 PARTS NUMBERED AND NAMED.

A cross-section view, showing clearly and distinctly all the interior of a Submarine of the latest type. You get more information from this chart, about the construction and operation of a Submarine, than in any other way. No details omitted—everything is accurate and to scale. It is absolutely correct in every detail, having been approved by Naval Engineers. All the machinery and devices fitted in a modern Submarine Boat are shown, and to make the engraving more readily understood, all the features are shown in operative form, with Officers and Men in the act of performing the duties assigned to them in service conditions. This CHART IS REALLY AN ENCYCLOPEDIA OF A SUBMARINE. . . . . 25 cents

## BOX CAR CHART.

A chart showing the anatomy of a box car, having every part of the car numbered and its proper name given in a reference list. . . . . 25 cents

## GONDOLA CAR CHART.

A chart showing the anatomy of a gondola car, having every part of the car numbered and its proper reference name given in a reference list. . . . . 25 cents

## PASSENGER-CAR CHART.

A chart showing the anatomy of a passenger-car, having every part of the car numbered and its proper name given in a reference list. . . . . 25 cents

## STEEL HOPPER BOTTOM COAL CAR.

A chart showing the anatomy of a steel Hopper Bottom Coal Car, having every part of the car numbered and its proper name given in a reference list. . . . . 25 cents

## TRACTIVE POWER CHART.

A chart whereby you can find the tractive power or drawbar pull of any locomotive without making a figure. Shows what cylinders are equal, how driving wheels and steam pressure affect the power. What sized engine you need to exert a given drawbar pull or anything you desire in this line. . . . . 50 cents

## HORSE-POWER CHART

Shows the horse-power of any stationary engine without calculation. No matter what the cylinder diameter or stroke, the steam pressure of cut-off, the revolutions, or whether condensing or non-condensing, it's all there. Easy to use, accurate, and saves time and calculations. Especially useful to engineers and designers. 50 cents

## CATALOGUE OF GOOD, PRACTICAL BOOKS

---

---

### BOILER ROOM CHART. By GEO. L. FOWLER.

A chart—size 14x28 inches—showing in isometric perspective the mechanisms belonging in a modern boiler room. The various parts are shown broken or removed, so that the internal construction is fully illustrated. Each part is given a reference number, and these, with the corresponding name, are given in a glossary printed at the sides. This chart is really a dictionary of the boiler room—the names of more than 200 parts being given. . . . . 25 cents

## COKE

### COKE—MODERN COKING PRACTICE, INCLUDING ANALYSIS OF MATERIALS AND PRODUCTS. By J. E. CHRISTOPHER and T. H. BYROM.

This, the standard work on the subject, has just been revised and is now issued in two volumes. It is a practical work for those engaged in Coke manufacture and the recovery of By-products. Fully illustrated with folding plates. It has been the aim of the authors, in preparing this book, to produce one which shall be of use and benefit to those who are associated with, or interested in, the modern developments of the industry. Among the chapters contained in Volume I are: Introduction. Classification of Fuels. Impurities of Coals. Coal Washing. Sampling and Valuation of Coals, etc. Chlorific Power of Fuels. History of Coke Manufacture. Developments in Coke Oven Design; Recent Types of Coke Ovens. Mechanical Appliances at Coke Ovens. Chemical and Physical Examination of Coke. Volume II covers By-products. Each volume is fully illustrated, with folding plates. Price, per volume . . . . . \$3.00

## COMPRESSED AIR

### COMPRESSED AIR IN ALL ITS APPLICATIONS. By GARDNER D. HISCOX.

This is the most complete book on the subject of Air that has ever been issued, and its thirty-five chapters include about every phase of the subject one can think of. It may be called an encyclopedia of compressed air. It is written by an expert, who, in its 665 pages, has dealt with the subject in a comprehensive manner, no phase of it being omitted. Includes the physical properties of air from a vacuum to its highest pressure, its thermodynamics, compression, transmission and uses as a motive power, in the Operation of Stationary and Portable Machinery, in Mining, Air Tools, Air Lifts, Pumping of Water, Acids, and Oils; the Air Blast for Cleaning and Painting, the Sand Blast and its Work, and the Numerous Appliances in which Compressed Air is a Most Convenient and Economical Transmitter of Power for Mechanical Work, Railway Propulsion, Refrigeration, and the Various Uses to which Compressed Air has been applied. Includes forty-four tables of the physical properties of air, its compression, expansion, and volumes required for various kinds of work, and a list of patents on compressed air from 1875 to date. Over 500 illustrations, 5th Edition, revised and enlarged. Cloth bound. Price . . . . . \$6.00

## CONCRETE

### JUST PUBLISHED—CONCRETE WORKERS' REFERENCE BOOKS. A SERIES OF POPULAR HANDBOOKS FOR CONCRETE USERS.

Prepared by A. A. HOUGHTON. . . . . Each 60 cents

*The author, in preparing this Series, has not only treated on the usual types of construction, but explains and illustrates molds and systems that are not patented, but which are equal in value and often superior to those restricted by patents. These molds are very easily and cheaply constructed and embody simplicity, rapidity of operation, and the most successful results in the molded concrete. Each of these Twelve books is fully illustrated, and the subjects are exhaustively treated in plain English.*

### CONCRETE WALL FORMS. By A. A. HOUGHTON.

A new automatic wall clamp is illustrated with working drawings. Other types of wall forms, clamps, separators, etc., are also illustrated and explained. (No. 1 of Series) . . . . . 75 cents

## CATALOGUE OF GOOD, PRACTICAL BOOKS

---

---

### CONCRETE FLOORS AND SIDEWALKS. By A. A. HOUGHTON.

The molds for molding squares, hexagonal and many other styles of mosaic floor and sidewalk blocks are fully illustrated and explained. (No. 2 of Series) . . . 75 cents

### PRACTICAL CONCRETE SILO CONSTRUCTION. By A. A. HOUGHTON.

Complete working drawings and specifications are given for several styles of concrete silos, with illustrations of molds for monolithic and block silos. The tables, data, and information presented in this book are of the utmost value in planning and constructing all forms of concrete silos. (No. 3 of Series) . . . . . 75 cents

### MOLDING CONCRETE CHIMNEYS, SLATE AND ROOF TILES. By A. A. HOUGHTON.

The manufacture of a 1 types of concrete slate and roof tile is fully treated. Valuable data on all forms of reinforced concrete roofs are contained within its pages. The construction of concrete chimneys by block and monolithic systems is fully illustrated and described. A number of ornamental designs of chimney construction with molds are shown in this valuable treatise. (No. 4 of Series.) . . . . . 75 cents

### MOLDING AND CURING ORNAMENTAL CONCRETE. By A. A. HOUGHTON.

The proper proportions of cement and aggregates for various finishes, also the method of thoroughly mixing and placing in the molds, are fully treated. An exhaustive treatise on this subject that every concrete worker will find of daily use and value. (No. 5 of Series.) . . . . . 75 cents

### CONCRETE MONUMENTS, MAUSOLEUMS AND BURIAL VAULTS. By A. A. HOUGHTON.

The molding of concrete monuments to imitate the most expensive cut stone is explained in this treatise, with working drawings of easily built molds. Cutting inscriptions and designs are also fully treated. (No. 6 of Series.) . . . . . 75 cents

### MOLDING CONCRETE BATHTUBS, AQUARIUMS AND NATATORIUMS. By A. A. HOUGHTON.

Simple molds and instruction are given for molding many styles of concrete bathtubs, swimming-pools, etc. These molds are easily built and permit rapid and successful work. (No. 7 of Series.) . . . . . 75 cents

### CONCRETE BRIDGES, CULVERTS AND SEWERS. By A. A. HOUGHTON.

A number of ornamental concrete bridges with illustrations of molds are given. A collapsible center or core for bridges, culverts and sewers is fully illustrated with detailed instructions for building. (No. 8 of Series.) . . . . . 75 cents

### CONSTRUCTING CONCRETE PORCHES. By A. A. HOUGHTON.

A number of designs with working drawings of molds are fully explained so any one can easily construct different styles of ornamental concrete porches without the purchase of expensive molds. (No. 9 of Series.) . . . . . 75 cents

### MOLDING CONCRETE FLOWER-POTS, BOXES, JARDINIERES, ETC. By A. A. HOUGHTON.

The molds for producing many original designs of flower-pots, urns, flower-boxes, jardinieres, etc., are fully illustrated and explained, so the worker can easily construct and operate same. (No. 10 of Series.) . . . . . 75 cents

### MOLDING CONCRETE FOUNTAINS AND LAWN ORNAMENTS. By A. A. HOUGHTON.

The molding of a number of designs of lawn seats, curbing, hitching posts, pergolas, sun dials and other forms of ornamental concrete for the ornamentation of lawns and gardens, is fully illustrated and described. (No. 11 of Series) . . . . . 75 cents

### CONCRETE FROM SAND MOLDS. By A. A. HOUGHTON.

A Practical Work treating on a process which has heretofore been held as a trade secret by the few who possessed it, and which will successfully mold every and any class of ornamental concrete work. The process of molding concrete with sand molds is of

## CATALOGUE OF GOOD, PRACTICAL BOOKS

---

the utmost practical value, possessing the manifold advantages of a low cost of molds, the ease and rapidity of operation, perfect details to all ornamental designs, density and increased strength of the concrete, perfect curing of the work without attention and the easy removal of the molds regardless of any undercutting the design may have. 192 pages. Fully illustrated. Price . . . . . \$2.00

### ORNAMENTAL CONCRETE WITHOUT MOLDS. By A. A. HOUGHTON.

The process for making ornamental concrete without molds has long been held as a secret, and now, for the first time, this process is given to the public. The book reveals the secret and is the only book published which explains a simple, practical method whereby the concrete worker is enabled, by employing wood and metal templates of different designs, to mold or model in concrete any Cornice, Archivol, Column, Pedestal, Base Cap, Urn or Pier in a monolithic form—right upon the job. These may be molded in units or blocks, and then built up to suit the specifications demanded. This work is fully illustrated, with detailed engravings. Price . \$2.00

### CONCRETE FOR THE FARM AND IN THE SHOP. By H. COLIN CAMPBELL, C.E., E.M.

"Concrete for the Farm and in the Shop" is a new book from cover to cover, illustrating and describing in plain, simple language many of the numerous applications of concrete within the range of the home worker. Among the subjects treated are:

Principles of reinforcing; methods of protecting concrete so as to insure proper hardening; home-made mixers; mixing by hand and machine; form construction, described and illustrated by drawings and photographs; construction of concrete walls and fences; concrete fence posts; concrete gate posts; corner posts; clothes line posts; grape arbor posts; tanks; troughs; cisterns; hog wallows; feeding floors and barnyard pavements; foundations; well curbs and platforms; indoor floors; sidewalks; steps; concrete hotbeds and cold frames; concrete slab roofs; walls for buildings; repairing leaks in tanks and cisterns; and all topics associated with these subjects as bearing upon securing the best results from concrete are dwelt upon at sufficient length in plain every-day English so that the inexperienced person desiring to undertake a piece of concrete construction can, by following the directions set forth in this book, secure 100 per cent success every time. A number of convenient and practical tables for estimating quantities, and some practical examples, are also given. (5 x 7). 149 pages, 51 illustrations. Price . . . . . \$1.00

### POPULAR HANDBOOK FOR CEMENT AND CONCRETE USERS. By MYRON H. LEWIS.

This is a concise treatise of the principles and methods employed in the manufacture and use of cement in all classes of modern works. The author has brought together in this work all the salient matter of interest to the user of concrete and its many diversified products. The matter is presented in logical and systematic order, clearly written, fully illustrated and free from involved mathematics. Everything of value to the concrete user is given, including kinds of cement employed in construction, concrete architecture, inspection and testing, waterproofing, coloring and painting, rules, tables, working and cost data. The book comprises thirty-three chapters, as follows:

Introductory. Kinds of Cements and How They are Made. Properties. Testing and Requirements of Hydraulic Cement. Concrete and its Properties. Sand, Broken Stone and Grave for Concrete. How to Proportion the Materials. How to Mix and Place Concrete. Forms of Concrete Construction. The Architectural and Artistic Possibilities of Concrete. Concrete Residences. Mortars, Plasters and Stucco, and How to Use them. The Artistic Treatment of Concrete Surfaces. Concrete Building Blocks. The Making of Ornamental Concrete. Concrete Pipes, Fences, Posts, etc. Essential Features and Advantages of Reinforced Concrete. How to Design Reinforced Concrete Beams, Slabs and Columns. Explanations of the Methods and Principles in Designing Reinforced Concrete Beams and Slabs. Systems of Reinforcement Employed. Reinforced Concrete in Factory and General Building Construction. Concrete in Foundation Work. Concrete Retaining Walls, Abutments and Bulkheads. Concrete Arches and Arch Bridges. Concrete Beam and Girder Bridges. Concrete in Sewerage and Drainage Works. Concrete Tanks, Dams and Reservoirs. Concrete Sidewalks, Curbs and Pavements. Concrete in Railroad Constructions. The Utility of Concrete on the Farm. The Waterproofing of Concrete Structure. Grout of Liquid Concrete and Its Use. Inspection of Concrete Work. Cost of Concrete Work. Some of the special features of the book are: 1. The Attention Paid to the Artistic and Architectural Side of Concrete Work. 2. The Authoritative

## CATALOGUE OF GOOD, PRACTICAL BOOKS

---

---

Treatment of the Problem of Waterproofing Concrete. 3. An Excellent Summary of the Rules to be Followed in Concrete Construction. 4. The Valuable Cost Data and Useful Tables given. A valuable Addition to the Library of Every Cement and Concrete User. Price . . . . . \$3.00

### WHAT IS SAID OF THIS BOOK:

"The field of Concrete Construction is well covered and the matter contained is well within the understanding of any person."—*Engineering-Contracting*.

"Should be on the bookshelves of every contractor, engineer, and architect in the land."—*National Builder*.

### WATERPROOFING CONCRETE. By MYRON H. LEWIS.

Modern Methods of Waterproofing Concrete and Other Structures. A condensed statement of the Principles, Rules, and Precautions to be Observed in Waterproofing and Dampproofing Structures and Structural Materials. Paper binding. Illustrated. Price . . . . . 75 cents

## DICTIONARIES

### STANDARD ELECTRICAL DICTIONARY. By T. O'CONNOR SLOANE.

An indispensable work to all interested in electrical science. Suitable alike for the student and professional. A practical handbook of reference containing definitions of about 5000 distinct words, terms and phrases. The definitions are terse and concise and include every term used in electrical science. Recently issued. An entirely new edition. Should be in the possession of all who desire to keep abreast with the progress of this branch of science. Complete, concise and convenient. Nearly 800 pages. Nearly 500 illustrations. 1920 Revised and Enlarged Edition. Price . . . . . \$5.00

### AVIATION TERMS—ENGLISH-FRENCH; FRENCH-ENGLISH. By MAJOR VICTOR W. PAGÉ, A.S., S.C.U.S.R., and LIEUT. PAUL MONTARIOL of the French Flying Corps.

A complete glossary of practically all terms used in aviation, having lists in both French and English with equivalents in either language. Include all words in common use. A complete, well illustrated volume intended to facilitate conversation between English-speaking and French aviators. The lists are confined to essentials, and special folding plates are included to show all important airplane parts. The lists are divided into four sections: 1. Flying Field Terms. 2. The Airplane. 3. The Engine. 4. Tools and Shop Terms. Should be in every aviator's and mechanic's kit. Price . . . . . \$1.00

## DIES—METAL WORK

### DIES: THEIR CONSTRUCTION AND USE FOR THE MODERN WORKING OF SHEET METALS. By J. V. WOODWORTH.

A most useful book, and one which should be in the hands of all engaged in the press working of metals; treating on the Designing, Constructing, and Use of Tools, Fixtures and Devices, together with the manner in which they should be used in the Power Press, for the cheap and rapid production of the great variety of sheet-metal articles now in use. It is designed as a guide to the production of sheet-metal parts at the minimum of cost with the maximum of output. The hardening and tempering of Press tools and the classes of work which may be produced to the best advantage by the use of dies in the power press are fully treated. Its 505 illustrations show dies, press fixtures and sheet-metal working devices, the descriptions of which are so clear and practical that all metal-working mechanics will be able to understand how to design, construct and use them. Many of the dies and press fixtures treated were either constructed by the author or under his supervision. Others were built by skilful mechanics and are in use in large sheet-metal establishments and machine shops. 5th Edition. Price . . . . . \$3.50



## CATALOGUE OF GOOD, PRACTICAL BOOKS

---

---

### **PUNCHES, DIES AND TOOLS FOR MANUFACTURING IN PRESSES.** By J. V. WOODWORTH.

This work is a companion volume to the author's elementary work entitled "Dies, Their Construction and Use." It does not go into the details of die-making to the extent of the author's previous book, but gives a comprehensive review of the field of operations carried on by presses. A large part of the information given has been drawn from the author's personal experience. It might well be termed an Encyclopedia of Die-Making, Punch-Making, Die-Sinking, Sheet-Metal Working, and Making of Special Tools, Sub-presses, Devices and Mechanical Combinations for Punching, Cutting, Bending, Forming, Piercing, Drawing, Compressing and Assembling Sheet-Metal Parts, and also Articles of other Materials in Machine Tools. 2d Edition. Price . . . . . \$4.50

### **DROP FORGING, DIE-SINKING AND MACHINE-FORMING OF STEEL.** By J. V. WOODWORTH.

This is a practical treatise on Modern Shop Practice, Processes, Methods, Machine Tools, and Details treating on the Hot and Cold Machine-Forming of Steel and Iron into Finished Shapes; together with Tools, Dies, and Machinery involved in the manufacture of Duplicate Forgings and Interchangeable Hot and Cold Pressed Parts from Bar and Sheet Metal. This book fills a demand of long standing for information regarding drop-forgings, die-sinking and machine-forming of steel and the shop practice involved, as it actually exists in the modern drop-forging shop. The processes of die-sinking and force-making, which are thoroughly described and illustrated in this admirable work, are rarely to be found explained in such a clear and concise manner as is here set forth. The process of die-sinking relates to the engraving or sinking of the female or lower dies, such as are used for drop forgings, hot and cold machine forging, swedging and the press working of metals. The process of force-making relates to the engraving or raising of the male or upper dies used in producing the lower dies for the press-forming and machine-forging of duplicate parts of metal.

In addition to the arts above mentioned the book contains explicit information regarding the drop-forging and hardening plants, designs, conditions, equipment, drop hammers, forging machines, etc., machine forging, hydraulic forging, autogenous welding and shop practice. The book contains eleven chapters, and the information contained in these chapters is just what will prove most valuable to the forged-metal worker. All operations described in the work are thoroughly illustrated by means of perspective half-tones and outline sketches of the machinery employed. 300 detailed illustrations. Price . . . . . \$3.00

## DRAWING—SKETCHING PAPER

### **PRACTICAL PERSPECTIVE.** By RICHARDS and COLVIN.

Shows just how to make all kinds of mechanical drawings in the only practical perspective isometric. Makes everything plain so that any mechanic can understand a sketch or drawing in this way. Saves time in the drawing room, and mistakes in the shops. Contains practical examples of various classes of work. 4th Edition. 75 cents

### **LINEAR PERSPECTIVE SELF-TAUGHT.** By HERMAN T. C. KRAUS.

This work gives the theory and practice of linear perspective, as used in architectural, engineering and mechanical drawings. Persons taking up the study of the subject by themselves will be able, by the use of the instruction given, to readily grasp the subject, and by reasonable practice become good perspective draftsmen. The arrangement of the book is good; the plate is on the left-hand, while the descriptive text follows on the opposite page, so as to be readily referred to. The drawings are on sufficiently large scale to show the work clearly and are plainly figured. There is included a self-explanatory chart which gives all information necessary for the thorough understanding of perspective. This chart alone is worth many times over the price of the book. 2d Revised and enlarged Edition. . . . . \$3.00

## CATALOGUE OF GOOD, PRACTICAL BOOKS

---

---

### SELF-TAUGHT MECHANICAL DRAWING AND ELEMENTARY MACHINE DESIGN. By F. L. SYLVESTER, M.E., Draftsman, with additions by ERIC OBERG, associate editor of "Machinery."

This is a practical treatise on Mechanical Drawing and Machine Design, comprising the first principles of geometric and mechanical drawing, workshop mathematics, mechanics, strength of materials and the calculations and design of machine details. The author's aim has been to adapt this treatise to the requirements of the practical mechanic and young draftsman and to present the matter in as clear and concise a manner as possible. To meet the demands of this class of students, practically all the important elements of machine design have been dealt with, and in addition algebraic formulas have been explained, and the elements of trigonometry treated in the manner best suited to the needs of the practical man. The book is divided into 20 chapters, and in arranging the material, mechanical drawing, pure and simple, has been taken up first, as a thorough understanding of the principles of representing objects facilitates the further study of mechanical subjects. This is followed by the mathematics necessary for the solution of the problems in machine design which are presented later, and a practical introduction to theoretical mechanics and the strength of materials. The various elements entering into machine design, such as cams, gears, sprocket-wheels, cone pulleys, bolts, screws, couplings, clutches, shafting and fly-wheels, have been treated in such a way as to make possible the use of the work as a text-book for a continuous course of study. It is easily comprehended and assimilated even by students of limited previous training. 330 pages, 215 engravings. Price . . \$2.50

### A NEW SKETCHING PAPER.

A new specially ruled paper to enable you to make sketches or drawings in isometric perspective without any figuring or fussing. It is being used for shop details as well as for assembly drawings, as it makes one sketch do the work of three, and no workman can help seeing just what is wanted. Pads of 40 sheets, 6x9 inches, 25 cents. Pads of 40 sheets, 9x12 inches, 50 cents; 40 sheets, 12x18, Price . . . . . \$1.00

## ELECTRICITY

### ARITHMETIC OF ELECTRICITY. By Prof. T. O'CONNOR SLOANE.

A practical treatise on electrical calculations of all kinds reduced to a series of rules, all of the simplest forms, and involving only ordinary arithmetic; each rule illustrated by one or more practical problems, with detailed solution of each one. This book is classed among the most useful works published on the science of electricity, covering as it does the mathematics of electricity in a manner that will attract the attention of those who are not familiar with algebraical formulas. 20th Edition. 160 pages. Price . . . . . \$1.50

### COMMUTATOR CONSTRUCTION. By WM. BAXTER, JR.

The business end of any dynamo or motor of the direct current type is the commutator. This book goes into the designing, building, and maintenance of commutators, shows how to locate troubles and how to remedy them; everyone who fusses with dynamos needs this. 4th Edition . . . . . 35 cents

### DYNAMO BUILDING FOR AMATEURS, OR HOW TO CONSTRUCT A FIFTY-WATT DYNAMO. By ARTHUR J. WEED, Member of N. Y. Electrical Society.

A practical treatise showing in detail the construction of a small dynamo or motor, the entire machine work of which can be done on a small foot lathe. Dimensioned working drawings are given for each piece of machine work, and each operation is clearly described. This machine, when used as a dynamo, has an output of fifty watts; when used as a motor it will drive a small drill press or lathe. It can be used to drive a sewing machine on any and all ordinary work. The book is illustrated with more than sixty original engravings showing the actual construction of the different parts. Among the contents are chapters on: 1. Fifty-Watt Dynamo. 2. Side Bearing

## CATALOGUE OF GOOD, PRACTICAL BOOKS

---

Rods. 3. Field Punching. 4. Bearings. 5. Commutator. 6. Pulley. 7. Brush Holders. 8. Connection Board. 9. Armature Shaft. 10. Armature. 11. Armature Winding. 12. Field Winding. 13. Connecting and Starting. Price, cloth, \$1.00

### ELECTRIC WIRING, DIAGRAMS AND SWITCHBOARDS. By NEWTON HARRISON.

A thoroughly practical treatise covering the subject of Electric Wiring in all its branches, including explanations and diagrams which are thoroughly explicit and greatly simplify the subject. Practical, every-day problems in wiring are presented and the method of obtaining intelligent results clearly shown. Only arithmetic is used. Ohm's law is given a simple explanation with reference to wiring for direct and alternating currents. The fundamental principle of drop of potential in circuits is shown with its various applications. The simple circuit is developed with the position of mains, feeders and branches; their treatment as a part of a wiring plan and their employment in house wiring clearly illustrated. Some simple facts about testing are included in connection with the wiring. Molding and conduit work are given careful consideration; and switchboards are systematically treated, built up and illustrated, showing the purpose they serve, for connection with the circuits, and to shunt and compound wound machines. The simple principles of switchboard construction, the development of the switchboard, the connections of the various instruments, including the lightning arrester, are also plainly set forth.

Alternating current wiring is treated, with explanations of the power factor, conditions calling for various sizes of wire, and a simple way of obtaining the sizes for single-phase, two-phase and three-phase circuits. This is the only complete work issued showing and telling you what you should know about direct and alternating current wiring. It is a ready reference. The work is free from advanced technicalities and mathematics, arithmetic being used throughout. It is in every respect a handy, well-written, instructive, comprehensive volume on wiring for the wireman, foreman, contractor, or electrician. 272 pages; 105 illustrations. Price . . . . . \$2.50

### ELECTRIC TOY MAKING, DYNAMO BUILDING, AND ELECTRIC MOTOR CONSTRUCTION. By Prof. T. O'CONNOR SLOANE.

This work treats of the making at home of electrical toys, electrical apparatus, motors, dynamos and instruments in general, and is designed to bring within the reach of young and old the manufacture of genuine and useful electrical appliances. The work is especially designed for amateurs and young folks.

Thousands of our young people are daily experimenting, and busily engaged in making electrical toys and apparatus of various kinds. The present work is just what is wanted to give the much needed information in a plain, practical manner, with illustrations to make easy the carrying out of the work. 20th Edition. Price . . . . \$1.50

### ELECTRICIANS' HANDY BOOK. By Prof. T. O'CONNOR SLOANE.

This work is intended for the practical electrician who has to make things go. The entire field of electricity is covered within its pages. Among some of the subjects treated are: The Theory of the Electric Current and Circuit, Electro-Chemistry, Primary Batteries, Storage Batteries, Generation and Utilization of Electric Powers, Alternating Current, Armature Winding, Dynamos and Motors, Motor Generators, Operation of the Central Station Switchboards, Safety Appliances, Distribution of Electric Light and Power, Street Mains, Transformers, Arc and Incandescent Lighting, Electric Measurements, Photometry, Electric Railways, Telephony, Bell-Wiring, Electric-Plating, Electric Heating, Wireless Telegraphy, etc. It contains no useless theory; everything is to the point. It teaches you just what you want to know about electricity. It is the standard work published on the subject. Forty-six chapters, 600 engravings. 1920 Revised and Enlarged Edition. Price . \$4.00

### ELECTRICITY SIMPLIFIED. By Prof. T. O'CONNOR SLOANE.

The object of "Electricity Simplified" is to make the subject as plain as possible and to show what the modern conception of electricity is; to show how two plates of different metal, immersed in acid, can send a message around the globe; to explain how a bundle of copper wire rotated by a steam engine can be the agent in lighting our streets, to tell what the volt, ohm and ampere are, and what high and low tension mean; and to answer the questions that perpetually arise in the mind in this age of electricity. 13th Edition. 172 pages. Illustrated. Price . . . . . \$1.50

# CATALOGUE OF GOOD, PRACTICAL BOOKS

## EXPERIMENTAL WIRELESS STATIONS. By P. E. EDELMAN.

The theory, design, construction and operation is fully treated including Wireless Telephony, Vacuum Tube, and quenched spark systems. The new enlarged 1920 edition is just issued and is strictly up to date, correct and complete. This book tells how to make apparatus to not only hear all telephoned and telegraphed radio messages, but also how to make simple equipment that works for transmission over reasonably long distances. Then there is a host of new information included. The first and only book to give you all the recent important radio improvements, some of which have never before been published. This volume anticipates every need of the reader who wants the gist of the art, its principles, simplified calculations, apparatus dimensions, and understandable directions for efficient operation.

Vacuum tube circuits; amplifiers; long-distance sets; loop, coil, and underground receivers; tables of wave-lengths, capacity, inductance; such are a few of the subjects presented in detail that satisfies. It is independent and one of the few that describe *all* modern systems.

Endorsed by foremost instructors for its clear accuracy, preferred by leading amateurs for its dependable designs. The new experimental Wireless Stations is sure to be most satisfactory for your purposes. 24 chapters. 167 illustrations. Price . . . \$3.00

## HOUSE WIRING. By THOMAS W. POPPE.

This work describes and illustrates the actual installation of Electric Light Wiring, the manner in which the work should be done, and the method of doing it. The book can be conveniently carried in the pocket. It is intended for the Electrician, Helper and Apprentice. It solves all Wiring Problems and contains nothing that conflicts with the rulings of the National Board of Fire Underwriters. It gives just the information essential to the Successful Wiring of a Building. Among the subjects treated are: Locating the Meter. Panel Boards. Switches. Plug Receptacles. Brackets. Ceiling Fixtures. The Meter Connections. The Feed Wires. The Steel Armored Cable System. The Flexible Steel Conduit System. The Rigid Conduit System. A digest of the National Board of Fire Underwriters' rules relating to metallic wiring systems. Various switching arrangements explained and diagrammed. The easiest method of testing the Three- and Four-way circuits explained. The grounding of all metallic wiring systems and the reason for doing so shown and explained. The insulation of the metal parts of lamp fixtures and the reason for the same described and illustrated. 125 pages. 2nd Edition, revised and enlarged. Fully illustrated. Flexible cloth. Price . . . . . \$1.00

### WHAT IS SAID OF THIS BOOK:

"The information given is exact and exhaustive without being too technical or overladen with details."—*Druggists' Circular*.

## HOW TO BECOME A SUCCESSFUL ELECTRICIAN. By Prof. T. O'CONNOR SLOANE.

Every young man who wishes to become a successful electrician should read this book. It tells in simple language the surest and easiest way to become a successful electrician. The studies to be followed, methods of work, field of operation and the requirements of the successful electrician are pointed out and fully explained. Every young engineer will find this an excellent stepping stone to more advanced works on electricity which he must master before success can be attained. Many young men become discouraged at the very outset by attempting to read and study books that are far beyond their comprehension. This book serves as the connecting link between the rudiments taught in the public schools and the real study of electricity. It is interesting from cover to cover. Eighteenth Revised Edition, just issued. 205 pages. Illustrated. Price . . . . . \$1.50

## STANDARD ELECTRICAL DICTIONARY. By T. O'CONNOR SLOANE.

An indispensable work to all interested in electrical science. Suitable alike for the student and professional. A practical handbook of reference containing definitions of about 5,000 distinct words, terms and phrases. The definitions are terse and concise and include every term used in electrical science. Recently issued. An entirely new edition. Should be in the possession of all who desire to keep abreast with the progress of this branch of science. In its arrangement and typography the book is very convenient. The word or term defined is printed in black-faced type which readily catches the eye, while the body of the page is in smaller but distinct type. The definitions are well worded, and so as to be understood by the non-technical reader. The general plan seems to be to give an exact, concise definition, and then amplify and explain in a more popular way. Synonyms are also given, and references to other

## CATALOGUE OF GOOD, PRACTICAL BOOKS

words and phrases are made. A very complete and accurate index of fifty pages is at the end of the volume; and as this index contains all synonyms, and as all phrases are indexed in every reasonable combination of words, reference to the proper place in the body of the book is readily made. It is difficult to decide how far a book of this character is to keep the dictionary form, and to what extent it may assume the encyclopedia form. For some purposes, concise, exactly worded definitions are needed; for other purposes, more extended descriptions are required. This book seeks to satisfy both demands, and does it with considerable success. Complete, concise and convenient. 800 pages. Nearly 500 illustrations. 1920 Revised and Enlarged Edition. Price . . . . . \$5.00

### SWITCHBOARDS. By WILLIAM BAXTER, JR.

This book appeals to every engineer and electrician who wants to know the practical side of things. It takes up all sorts and conditions of dynamos, connections and circuits, and shows by diagram and illustration just how the switchboard should be connected. Includes direct and alternating current boards, also those for arc lighting, incandescent and power circuits. Special treatment on high voltage boards for power transmission. 2d Edition. 190 pages. Illustrated. Price . . . . . \$2.00

### TELEPHONE CONSTRUCTION, INSTALLATION, WIRING, OPERATION AND MAINTENANCE. By W. H. RADCLIFFE and H. C. CUSHING.

This book is intended for the amateur, the wireman, or the engineer who desires to establish a means of telephonic communication between the rooms of his home, office, or shop. It deals only with such things as may be of use to him rather than with theories.

Gives the principles of construction and operation of both the Bell and Independent instruments; approved methods of installing and wiring them; the means of protecting them from lightning and abnormal currents; their connection together for operation as series or bridging stations; and rules for their inspection and maintenance. Line wiring and the wiring and operation of special telephone systems are also treated.

Intricate mathematics are avoided, and all apparatus, circuits and systems are thoroughly described. The appendix contains definitions of units and terms used in the text. Selected wiring tables, which are very helpful, are also included. Among the subjects treated are Construction, Operation, and Installation of Telephone Instruments; Inspection and Maintenance of Telephone Instruments; Telephone Line Wiring; Testing Telephone Line Wires and Cables; Wiring and Operation of Special Telephone Systems, etc. 2nd Edition, revised and enlarged. 223 pages. 154 illustrations . . . . . \$1.50

### WIRELESS TELEGRAPHY AND TELEPHONY SIMPLY EXPLAINED. By ALFRED P. MORGAN.

This is undoubtedly one of the most complete and comprehensible treatises on the subject ever published, and a close study of its pages will enable one to master all the details of the wireless transmission of messages. The author has filled a long-felt want and has succeeded in furnishing a lucid, comprehensible explanation in simple language of the theory and practice of wireless telegraphy and telephony.

Among the contents are: Introductory; Wireless Transmission and Reception—The Aerial System, Earth Connections—The Transmitting Apparatus, Spark Coils and Transformers, Condensers, Helixes, Spark Gaps, Anchor Gaps, Aerial Switches—The Receiving Apparatus, Detectors, etc.—Tuning and Coupling, Tuning Coils, Loose Couplers, Variable Condensers, Directive Wave Systems—Miscellaneous Apparatus, Telephone Receivers, Range of Stations, Static Interference—Wireless Telephones, Sound and Sound Waves, The Vocal Cords and Ear—Wireless Telephone, How Sounds Are Changed into Electric Waves—Wireless Telephones, The Apparatus—Summary. 154 pages. 156 engravings. Price . . . . . \$1.50

#### WHAT IS SAID OF THIS BOOK:

"This book should be in both the home and school library."—*The Youths' Instructor*.

### WIRING A HOUSE. By HERBERT PRATT.

Shows a house already built; tells just how to start about wiring it; where to begin; what wire to use; how to run it according to Insurance Rules; in fact, just the information you need. Directions apply equally to a shop. Fourth edition . . . 35 cents

## CATALOGUE OF GOOD, PRACTICAL BOOKS

---

### RADIO TIME SIGNAL RECEIVER. By AUSTIN C. LESCARBOURA.

This new book, "A Radio Time Signal Receiver," tells you how to build a simple outfit designed expressly for the beginner. You can build the outfits in your own workshop and install them for jewelers either on a one-payment or a rental basis. The apparatus is of such simple design that it may be made by the average amateur mechanic possessing a few ordinary tools. 42 pages. Paper. Price . . . **35 cents**

### CONSTRUCTION OF A TRANSATLANTIC WIRELESS RECEIVING SET.

By L. G. PACENT and T. S. CURTIS.

A work for the Radio student who desires to construct and operate apparatus that will permit of the reception of messages from the large stations in Europe with an aerial of amateur proportions. 36 pages. 23 illustrations, cloth. Price . **35 cents**

### ELECTRIC BELLS. By M. B. SLEEPER.

A complete treatise for the practical worker in installing, operating, and testing bell circuits, burglar alarms, thermostats, and other apparatus used with electric bells. Both the electrician and the experimenter will find in this book new material which is essential in their work. Tools, bells, batteries, unusual circuits, burglar alarms, annunciators, systems, thermostats, circuit breakers, time alarms, and other apparatus used in bell circuits are described from the standpoints of their application, construction, and repair. The detailed instructions for building the apparatus will appeal to the experimenter particularly. The practical worker will find the chapters on Wiring Calculation of Wire Sizes and Magnet Windings, Upkeep of Systems and the Location of Faults of the greatest value in their work. 124 pages. Fully illustrated. Price . . . . . **75 cents**

### EXPERIMENTAL HIGH FREQUENCY APPARATUS — HOW TO MAKE AND USE IT. By THOMAS STANLEY CURTIS.

This book tells you how to build simple high frequency coils for experimental purpose in the home, school laboratory, or on the small lecture platform. The book is really a supplement to the same author's "High Frequency Apparatus." The experimental side only is covered in this volume, which is intended for those who want to build small coils giving up to an eighteen-inch spark. The book contains valuable information for the physics or the manual training teacher who is on the lookout for interesting projects for his boys to build or experiment with. The apparatus is simple, cheap and perfectly safe, and with it some truly startling experiments may be performed. Among the contents are: Induction Coil Outfits Operated on Battery Current. Kicking Coil Apparatus. One-Half Kilowatt Transformer Outfit. Parts and Materials, etc., etc. 69 pages. Illustrated. Price . . . . . **50 cents**

### HIGH FREQUENCY APPARATUS, ITS CONSTRUCTION AND PRACTICAL APPLICATION. By THOMAS STANLEY CURTIS

The most comprehensive and thorough work on this interesting subject ever produced. The book is essentially practical in its treatment and it constitutes an accurate record of the researches of its author over a period of several years, during which time dozens of coils were built and experimented with. The work has been divided into six basic parts. The first two chapters tell the uninitiated reader what the high frequency current is, what it is used for, and how it is produced. The second section, comprising four chapters, describes in detail the principles of the transformer, condenser, spark gap, and oscillation transformer, and covers the main points in the design and construction of these devices as applied to the work in hand. The third section covers the construction of small high frequency outfits designed for experimental work in the home laboratory or in the classroom. The fourth section is devoted to electro-therapeutic and X-Ray apparatus. The fifth describes apparatus for the cultivation of plants and vegetables. The sixth section is devoted to a comprehensive discussion of apparatus of large size for use upon the stage in spectacular productions. The closing chapter, giving the current prices of the parts and materials required for the construction of the apparatus described, is included with a view to expediting the purchase of the necessary goods. The Second Edition includes much new matter along the line of home-made therapeutic outfits for physicians' use. The matter on electro plant culture has also been elaborated upon. Second Revised and Enlarged Edition. 248 pages. 1920. Fully illustrated. Price . . . . . **\$3.00**

## CATALOGUE OF GOOD, PRACTICAL BOOKS

---

---

### STORAGE BATTERIES SIMPLIFIED. By VICTOR W. PAGÉ, M.S.A.E.

A complete treatise on storage battery operating principles, repairs and applications. The greatly increasing application of storage batteries in modern engineering and mechanical work has created a demand for a book that will consider this subject completely and exclusively. This is the most thorough and authoritative treatise ever published on this subject. It is written in easily understandable, non technical language so that any one may grasp the basic principles of storage battery action as well as their practical industrial applications. All electric and gasoline automobiles use storage batteries. Every automobile repairman, dealer or salesman should have a good knowledge of maintenance and repair of these important elements of the motor car mechanism. This book not only tells how to charge, care for and rebuild storage batteries but also outlines all the industrial uses. Learn how they run street cars, locomotives and factory trucks. Get an understanding of the important functions they perform in submarine boats, isolated lighting plants, railway switch and signal systems, marine applications, etc. This book tells how they are used in central station standby service, for starting automobile motors and in ignition systems. Every practical use of the modern storage battery is outlined in this treatise.

Chapters contained are: Chapter 1—Storage Battery Development—Types of Storage Batteries—Lead Plate Types—The Edison Cell. Chapter 2—Storage Battery Construction—Plates and Grids—Planté Plates—Fauré Plates—Non-Lead Plates—Commercial Battery Designs. Chapter 3—Charging Methods—Rectifiers—Converters—Rheostats—Rules for Charging. Chapter 4—Battery Repairs and Maintenance. Chapter 5—Industrial Application of Storage Batteries—Glossary of Storage Battery Terms. 208 pages. Fully illustrated. Price . . . . \$2.00

## ELECTROPLATING

### A NEW ELECTROPLATING BOOK. By KENNETH M. COGGESHALL.

This is one of the most complete and practical books on electroplating and allied processes that has been published as a text for the student or professional plater. It is written in simple language and explains all details of electroplating in a concise yet complete manner. It starts at the beginning and gives an elementary outline of electricity and chemistry as relates to plating, then considers shop layout and equipment and gives all the necessary information to do reliable and profitable electroplating in a modern commercial manner. Full instructions are given for the preparation and finishing of the work and formulae and complete directions are included for making all kinds of plating solutions, many of these having been trade secrets until published in this instruction manual. Any one interested in practical plating and metal finishing will find this book a valuable guide and complete manual of the art. Cloth. 135 illustrations. Nearly 300 pages. Price . . . . . \$3.00

## FACTORY MANAGEMENT, ETC.

### MODERN MACHINE SHOP CONSTRUCTION, EQUIPMENT AND MANAGEMENT. By O. E. PERRIGO, M.E.

The only work published that describes the modern machine shop or manufacturing plant from the time the grass is growing on the site intended for it until the finished product is shipped. By a careful study of its thirty-two chapters the practical man may economically build, efficiently equip, and successfully manage the modern machine shop or manufacturing establishment. Just the book needed by those contemplating the erection of modern shop buildings, the rebuilding and reorganization of old ones, or the introduction of modern shop methods, time and cost systems. It is a book written and illustrated by a practical shop man for practical shop men who are too busy to read theories and want facts. It is the most complete all-around book of its kind ever published. It is a practical book for practical men, from the apprentice in the shop to the president in the office. It minutely describes and illustrates the most simple and yet the most efficient time and cost system yet devised. Price . \$5.00

---

---

## CATALOGUE OF GOOD, PRACTICAL BOOKS

---

---

### FUEL

#### COMBUSTION OF COAL AND THE PREVENTION OF SMOKE. By WM. M. BARR.

This book has been prepared with special reference to the generation of heat by the combustion of the common fuels found in the United States, and deals particularly with the conditions necessary to the economic and smokeless combustion of bituminous coals in Stationary and Locomotive Steam Boilers.

The presentation of this important subject is systematic and progressive. The arrangement of the book is in a series of practical questions to which are appended accurate answers, which describe in language, free from technicalities, the several processes involved in the furnace combustion of American fuels; it clearly states the essential requisites for perfect combustion, and points out the best methods for furnace construction for obtaining the greatest quantity of heat from any given quality of coal. Nearly 350 pages, fully illustrated. Price . . . . . \$1.50

### GAS ENGINES AND GAS

#### THE GASOLINE ENGINE ON THE FARM: ITS OPERATION, REPAIR AND USES. By XENO W. PUTNAM.

This is a practical treatise on the Gasoline and Kerosene Engine intended for the man who wants to know just how to manage his engine and how to apply it to all kinds of farm work to the best advantage.

This book abounds with hints and helps for the farm and suggestions for the home and housewife. There is so much of value in this book that it is impossible to adequately describe it in such small space. Suffice to say that it is the kind of a book every farmer will appreciate and every farm home ought to have. Includes selecting the most suitable engine for farm work, its most convenient and efficient installation, with chapters on troubles, their remedies, and how to avoid them. The care and management of the farm tractor in plowing, harrowing, harvesting and road grading are fully covered; also plain directions are given for handling the tractor on the road. Special attention is given to relieving farm life of its drudgery by applying power to the disagreeable small tasks which must otherwise be done by hand. Many home-made contrivances for cutting wood, supplying kitchen, garden, and barn with water, loading, hauling and unloading hay, delivering grain to the bins or the feed trough are included; also full directions for making the engine milk the cows, churn, wash, sweep the house and clean the windows, etc. Very fully illustrated with drawings of working parts and cuts showing Stationary, Portable and Tractor Engines doing all kinds of farm work. All money-making farms utilize power. Learn how to utilize power by reading the pages of this book. It is an aid to the result getter, invaluable to the up-to-date farmer, student, blacksmith, implement dealer and, in fact, all who can apply practical knowledge of stationary gasoline engines or gas tractors to advantage. 530 pages. Nearly 180 engravings. Price . . . . . \$3.00

#### WHAT IS SAID OF THIS BOOK:

"Am much pleased with the book and find it to be very complete and up-to-date. I will heartily recommend it to students and farmers whom I think would stand in need of such a work, as I think it is an exceptionally good one."—*N. S. Gardiner*, Prof. in Charge, Clemson Agr. College of S. C.; Dept. of Agri. and Agri. Exp. Station, Clemson College, S. C.

"I feel that Mr. Putnam's book covers the main points which a farmer should know."—*R. T. Burdick*, Instructor in Agronomy, University of Vermont, Burlington, Vt.

"It will be a valuable addition to our library upon Farm Machinery."—*James A. Farra*, Inst. in Agri. Engineering, State University of Ky., Lexington, Ky.

#### GASOLINE ENGINES: THEIR OPERATION, USE AND CARE. By A. HYATT VERRILL.

The simplest, latest and most comprehensive popular work published on Gasoline Engines, describing what the Gasoline Engine is; its construction and operation; how to install it; how to select it; how to use it and how to remedy troubles encountered.



## CATALOGUE OF GOOD, PRACTICAL BOOKS

---

Intended for Owners, Operators and Users of Gasoline Motors of all kinds. This work fully describes and illustrates the various types of Gasoline Engines used in Motor Boats, Motor Vehicles and Stationary Work. The parts, accessories and appliances are described, with chapters on ignition, fuel, lubrication, operation and engine troubles. Special attention is given to the care, operation and repair of motors, with useful hints and suggestions on emergency repairs and makeshifts. A complete glossary of technical terms and an alphabetically arranged table of troubles and their symptoms form most valuable and unique features of this manual. Nearly every illustration in the book is original, having been made by the author. Every page is full of interest and value. A book which you cannot afford to be without. 275 pages, 152 specially made engravings. Price . . . . . \$2.00

### **GAS, GASOLINE, AND OIL ENGINES.** By GARDNER D. HISCOX.

Just issued, 22d revised and enlarged edition. Every user of a gas engine needs this book. Simple, instructive, and right up-to-date. The only complete work on the subject. Tells all about the running and management of gas, gasoline and oil engines, as designed and manufactured in the United States. Explosive motors for stationary marine and vehicle power are fully treated, together with illustrations of their parts and tabulated sizes, also their care and running are included. Electric ignition by induction coil and jump spark are fully explained and illustrated, including valuable information on the testing for economy and power and the erection of power plants.

The rules and regulations of the Board of Fire Underwriters in regard to the installation and management of gasoline motors are given in full, suggesting the safe installation of explosive motor power. A list of United States Patents issued on gas, gasoline, and oil engines and their adjuncts from 1875 to date is included. 640 pages. 435 engravings. Folding plates. Price . . . . . \$3.00

### **GAS ENGINE CONSTRUCTION, OR HOW TO BUILD A HALF-HORSE-POWER GAS ENGINE.** By PARSELL and WEED.

A practical treatise of 300 pages describing the theory and principles of the action of Gas Engines of various types and the design and construction of a half-horse-power Gas Engine, with illustrations of the work in actual progress, together with the dimensioned working drawings, giving clearly the sizes of the various details; for the student, the scientific investigator, and the amateur mechanic. This book treats of the subject more from the standpoint of practice than that of theory. The principles of operation of Gas Engines are clearly and simply described, and then the actual construction of a half-horse-power engine is taken up, step by step, showing in detail the making of the Gas Engine. 3d Edition. 300 pages. Price . . . . . \$3.00

### **HOW TO RUN AND INSTALL GASOLINE ENGINES.** By C. VON CULIN.

Revised and enlarged edition just issued. The object of this little book is to furnish a pocket instructor for the beginner, the busy man who uses an engine for pleasure or profit, but who does not have the time or inclination for a technical book, but simply to thoroughly understand how to properly operate, install and care for his own engine. The index refers to each trouble, remedy, and subject alphabetically. Being a quick reference to find the cause, remedy and prevention for troubles, and to become an expert with his own engine. Pocket size. Paper binding. Price . . . . . 25 cents

### **THE MODERN GAS TRACTOR.** By VICTOR W. PAGÉ.

A complete treatise describing all types and sizes of gasoline, kerosene and oil tractors. Considers design and construction exhaustively, gives complete instructions for care, operation and repair, outlines all practical applications on the road and in the field. The best and latest work on farm tractors and tractor power plants. A work needed by farmers, students, blacksmiths, mechanics, salesmen, implement dealers, designers and engineers. 500 pages. Nearly 300 illustrations and folding plates. Price \$3.00

### **CHEMISTRY OF GAS MANUFACTURE.** By H. M. ROYLE.

This book covers points likely to arise in the ordinary course of the duties of the engineer or manager of a gas works not large enough to necessitate the employment of a separate chemical staff. It treats of the testing of the raw materials employed in the manufacture of illuminating coal gas and of the gas produced. The preparation of standard solutions is given as well as the chemical and physical examination of gas coal. 5¼ x 8¾. Cloth, 328 pages. 82 illustrations, 1 colored plate. Price \$5.00

**GEARING AND CAMS**

**BEVEL GEAR TABLES.** By D. AG. ENGSTROM.

A book that will at once commend itself to mechanics and draftsmen. Does away with all the trigonometry and fancy figuring on bevel gears, and makes it easy for anyone to lay them out or make them just right. There are 36 full-page tables that show every necessary dimension for all sizes or combinations you're apt to need. No puzzling, figuring or guessing. Gives placing distance, all the angles (including cutting angles), and the correct cutter to use. A copy of this prepares you for anything in the bevel-gear line. 3d Edition. 66 pages. . . . . \$1.50

**CHANGE GEAR DEVICES.** By OSCAR E. PERRIGO.

A practical book for every designer, draftsman, and mechanic interested in the invention and development of the devices for feed changes on the different machines requiring such mechanism. All the necessary information on this subject is taken up, analyzed, classified, sifted, and concentrated for the use of busy men who have not the time to go through the masses of irrelevant matter with which such a subject is usually encumbered and select such information as will be useful to them.

It shows just what has been done, how it has been done, when it was done, and who did it. It saves time in hunting up patent records and re-inventing old ideas. 88 pages. . . . . \$1.50

**DRAFTING OF CAMS.** By LOUIS ROUILLON.

The laying out of cams is a serious problem unless you know how to go at it right. This puts you on the right road for practically any kind of cam you are likely to run up against. 3d Edition. . . . . 35 cents

**HYDRAULICS**

**HYDRAULIC ENGINEERING.** By GARDNER D. HISCOX.

A treatise on the properties, power, and resources of water for all purposes. Including the measurement of streams, the flow of water in pipes or conduits; the horse-power of falling water, turbine and impact water-wheels, wave motors, centrifugal, reciprocating and air-lift pumps. With 300 figures and diagrams and 36 practical tables. All who are interested in water-works development will find this book a useful one, because it is an entirely practical treatise upon a subject of present importance, and cannot fail in having a far-reaching influence, and for this reason should have a place in the working library of every engineer. Among the subjects treated are: Historical Hydraulics, Properties of Water, Measurement of the Flow of Streams; Flow from Sub-surface Orifices and Nozzles; Flow of Water in Pipes; Siphons of Various Kinds; Dams and Great Storage Reservoirs; City and Town Water Supply; Wells and Their Reinforcement; Air Lift Methods of Raising Water; Artesian Wells; Irrigation of Arid Districts; Water Power; Water Wheels; Pumps and Pumping Machinery; Reciprocating Pumps; Hydraulic Power Transmission; Hydraulic Mining; Canals; Ditches; Conduits and Pipe Lines; Marine Hydraulics; Tidal and Sea Wave Power, etc. 320 pages. Price . . . . . \$4.50

**ICE AND REFRIGERATION**

**POCKETBOOK OF REFRIGERATION AND ICE MAKING.** By A. J. WALLIS-TAYLOR.

This is one of the latest and most comprehensive reference books published on the subject of refrigeration and cold storage. It explains the properties and refrigerating effect of the different fluids in use, the management of refrigerating machinery and the construction and insulation of cold rooms with their required pipe surface for different degrees of cold; freezing mixtures and non-freezing brines, temperatures of cold rooms for all kinds of provisions, cold storage charges for all classes of goods, ice making and storage of ice, data and memoranda for constant reference by refrigerating engineers, with nearly one hundred tables containing valuable references to every fact and condition required in the installment and operation of a refrigerating plant. New edition just published. Price . . . . . \$2.00

INVENTIONS—PATENTS

**INVENTORS' MANUAL, HOW TO MAKE A PATENT PAY.**

This is a book designed as a guide to inventors in perfecting their inventions, taking out their patents and disposing of them. It is not in any sense a Patent Solicitor's Circular nor a Patent Broker's Advertisement. No advertisements of any description appear in the work. It is a book containing a quarter of a century's experience of a successful inventor, together with notes based upon the experience of many other inventors.

Among the subjects treated in this work are: How to Invent. How to Secure a Good Patent. Value of Good Invention. How to Exhibit an Invention. How to Interest Capital. How to Estimate the Value of a Patent. Value of Design Patents. Value of Foreign Patents. Value of Small Inventions. Advice on Selling Patents. Advice on the Formation of Stock Companies. Advice on the Formation of Limited Liability Companies. Advice on Disposing of Old Patents. Advice as to Patent Attorneys. Advice as to Selling Agents. Forms of Assignments. License and Contracts. State Laws Concerning Patent Rights. 1900 Census of the United States by Counts of Over 10,000 Population. New revised and enlarged edition. 144 pages. Illustrated. Price . . . . . \$1.25

KNOTS

**KNOTS, SPLICES AND ROPE WORK.** By A. HYATT VERRILL.

This is a practical book giving complete and simple directions for making all the most useful and ornamental knots in common use, with chapters on Splicing, Pointing, Seizing, Serving, etc. This book is fully illustrated with one hundred and fifty original engravings, which show how each knot, tie or splice is formed, and its appearance when finished. The book will be found of the greatest value to Campers, Yachtsmen, Travelers, Boy Scouts, in fact, to anyone having occasion to use or handle rope or knots for any purpose. The book is thoroughly reliable and practical, and is not only a guide, but a teacher. It is the standard work on the subject. Among the contents are: 1. Cordage, Kinds of Rope. Construction of Rope, Parts of Rope Cable and Bolt Rope. Strength of Rope, Weight of Rope. 2. Simple Knots and Bends. Terms Used in Handling Rope. Seizing Rope. 3. Ties and Hitches. 4. Noose, Loops and Mooring Knots. 5. Shortenings, Grommets and Salvages. 6. Lashings, Seizings and Splices. 7. Fancy Knots and Rope Work. 128 pages. 150 original engravings. Price . . . . . \$1.00

LATHE WORK

**LATHE DESIGN, CONSTRUCTION, AND OPERATION, WITH PRACTICAL EXAMPLES OF LATHE WORK.** By OSCAR E. PERRIGO.

A new revised edition, and the only complete American work on the subject, written by a man who knows not only how work ought to be done, but who also knows how to do it, and how to convey this knowledge to others. It is strictly up-to-date in its descriptions and illustrations. Lathe history and the relations of the lathe to manufacturing are given; also a description of the various devices for feeds and thread cutting mechanisms from early efforts in this direction to the present time. Lathe design is thoroughly discussed, including back gearing, driving cones, thread-cutting gears, and all the essential elements of the modern lathe. The classification of lathes is taken up, giving the essential differences of the several types of lathes including, as is usually understood, engine lathes, bench lathes, speed lathes, forge lathes, gap lathes, pulley lathes, forming lathes, multiple-spindle lathes, rapid-reduction lathes, precision lathes, turret lathes, special lathes, electrically-driven lathes, etc. In addition to the complete exposition on construction and design, much practical matter on lathe installation, care and operation has been incorporated in the enlarged 1915 edition. All kinds of lathe attachments for drilling, milling, etc., are described and complete instructions are given to enable the novice machinist to grasp the art of lathe operation as well as the principles involved in design. A number of difficult machining

## CATALOGUE OF GOOD, PRACTICAL BOOKS

---

---

operations are described at length and illustrated. The new edition has nearly 500 pages and 350 illustrations. Price . . . . . \$3.00

### WHAT IS SAID OF THIS BOOK:

"This is a lathe book from beginning to end, and is just the kind of a book which one delights to consult,—a masterly treatment of the subject in hand."—*Engineering News*.  
"This work will be of exceptional interest to anyone who is interested in lathe practice, as one very seldom sees such a complete treatise on a subject as this is on the lathe."—*Canadian Machinery*.

### LATHE WORK FOR BEGINNERS. By RAYMOND FRANCIS YATES.

A simple, straightforward textbook for those desiring to learn the operation of a wood-turning or metal-turning lathe. The first chapter tells how to choose a lathe and all of the standard types on the market are described. Simple and more advanced lathe work is thoroughly covered and the operation of all lathe attachments such as millers, grinders, polishers, etc., is described. The treatment starts from the very bottom and leads the reader through to a point where he will be able to handle the larger commercial machines with very little instruction. The last chapter of the book is devoted to things to make on the lathe and includes a model rapid-fire naval gun. This is the only book published in this country that treats lathe work from the standpoint of the amateur mechanic. 162 illustrations. About 250 pages 1<sup>2</sup>mo. Price . . . . . \$2.00

### TURNING AND BORING TAPERS. By FRED H. COLVIN.

There are two ways to turn tapers; the right way and one other. This treatise has to do with the right way; it tells you how to start the work properly, how to set the lathe, what tools to use and how to use them, and forty and one other little things that you should know. Fourth edition. Price . . . . . 35 cents

## LIQUID AIR

### LIQUID AIR AND THE LIQUEFACTION OF GASES. By T. O'CONNOR SLOANE.

This book gives the history of the theory, discovery, and manufacture of Liquid Air, and contains an illustrated description of all the experiments that have excited the wonder of audiences all over the country. It shows how liquid air, like water, is carried hundreds of miles and is handled in open buckets. It tells what may be expected from it in the near future.

A book that renders simple one of the most perplexing chemical problems of the century. Startling developments illustrated by actual experiments.

It is not only a work of scientific interest and authority, but is intended for the general reader, being written in a popular style—easily understood by every one. Third edition. Revised and Enlarged. 394 pages. 1920 Edition. Price . . . \$3.00

## LOCOMOTIVE ENGINEERING

### AIR-BRAKE CATECHISM. By ROBERT H. BLACKALL.

This book is a standard text book. It covers the Westinghouse Air-Brake Equipment, including the No. 5 and the No. 6 E. T. Locomotive Brake Equipment; the K (Quick Service) Triple Valve for Freight Service; and the Cross-Compound Pump. The operation of all parts of the apparatus is explained in detail, and a practical way of finding their peculiarities and defects, with a proper remedy, is given. It contains 2,000 questions with their answers, which will enable any railroad man to pass any examination on the subject of Air Brakes. Endorsed and used by air-brake instructors and examiners on nearly every railroad in the United States. 27th Edition. 411 pages, fully illustrated with colored plates and diagrams. Price . . . . . \$2.50

## CATALOGUE OF GOOD, PRACTICAL BOOKS

---

### COMBUSTION OF COAL AND THE PREVENTION OF SMOKE. By WM. M. BARR.

This book has been prepared with special reference to the generation of heat by the combustion of the common fuels found in the United States and deals particularly with the conditions necessary to the economic and smokeless combustion of bituminous coal in Stationary and Locomotive Steam Boilers.

Presentation of this important subject is systematic and progressive. The arrangement of the book is in a series of practical questions to which are appended accurate answers, which describe in language free from technicalities the several processes involved in the furnace combustion of American fuels; it clearly states the essential requisites for perfect combustion, and points out the best methods of furnace construction for obtaining the greatest quantity of heat from any given quality of coal. Nearly 350 pages, fully illustrated. Price . . . . . \$1.50

### DIARY OF A ROUND-HOUSE FOREMAN. By T. S. REILLY.

This is the greatest book of railroad experiences ever published. Containing a fund of information and suggestions along the line of handling men, organizing, etc., that one cannot afford to miss. 176 pages. Price . . . . . \$1.25

### LINK MOTIONS, VALVES AND VALVE SETTING. By FRED H. COLVIN, Associate Editor of *American Machinist*.

A handy book for the engineer or machinist that clears up the mysteries of valve setting. Shows the different valve gears in use, how they work, and why. Piston and slide valves of different types are illustrated and explained. A book that every railroad man in the motive power department ought to have. Contains chapters on Locomotive Link Motion, Valve Movements, Setting Slide Valves, Analysis by Diagrams, Modern Practice, Slip of Block, Slice Valves, Piston Valves, Setting Piston Valves, Joy-Allen Valve Gear, Walschaert Valve Gear, Gooch Valve Gear, Alfreed-Hubbell Valve Gear, etc., etc. Fully illustrated. Price . . . . . 75 cents

### LOCOMOTIVE BOILER CONSTRUCTION. By FRANK A. KLEINHANS.

The construction of boilers in general is treated, and, following this, the locomotive boiler is taken up in the order in which its various parts go through the shop. Shows all types of boilers used; gives details of construction; practical facts, such as life of riveting, punches and dies; work done per day, allowance for bending and flanging sheets, and other data. Including the recent Locomotive Boiler Inspection Laws and Examination Questions with their answers for Government Inspectors. Contains chapters on Laying Out Work; Flanging and Forging; Punching; Shearing; Plate Planing; General Tables; Finishing Parts; Bending; Machinery Parts; Riveting; Boiler Details; Smoke Box Details; Assembling and Calking; Boiler Shop Machinery, etc., etc.

There isn't a man who has anything to do with boiler work, either new or repair work, who doesn't need this book. The manufacturer, superintendent, foreman, and boiler worker—all need it. No matter what the type of boiler, you'll find a mint of information that you wouldn't be without. Over 400 pages, five large folding plates. Price . . . . . \$3.50

### LOCOMOTIVE BREAKDOWNS AND THEIR REMEDIES. By GEO. L. FOWLER. Revised by WM. W. WOOD, Air-Brake Instructor. Just issued. Revised pocket edition.

It is out of the question to try and tell you about every subject that is covered in this pocket edition of Locomotive Breakdowns. Just imagine all the common troubles that an engineer may expect to happen some time, and then add all of the unexpected ones, troubles that could occur, but that you have never thought about, and you will find that they are all treated with the very best methods of repair. Walschaert Locomotive Valve Gear Troubles, Electric Headlight Troubles, as well as Questions and Answers on the Air Brake are all included. 312 pages. 8th Revised Edition. Fully illustrated. . . . . \$1.50

### LOCOMOTIVE CATECHISM. By ROBERT GRIMSHAW.

The revised edition of "Locomotive Catechism," by Robert Grimshaw, is a New Book from Cover to Cover. It contains twice as many pages and double the number of

## CATALOGUE OF GOOD, PRACTICAL BOOKS

---

---

illustrations of previous editions. Includes the greatest amount of practical information ever published on the construction and management of modern locomotives. Specially Prepared Chapters on the Walschaert Locomotive Valve Gear, the Air-Brake Equipment and the Electric Headlight are given.

It commends itself at once to every Engineer and Fireman, and to all who are going in for examination or promotion. In plain language, with full, complete answers, not only all the questions asked by the examining engineer are given, but those which the young and less experienced would ask the veteran, and which old hands ask as "stickers." It is a veritable Encyclopedia of the Locomotive, is entirely free from mathematics, easily understood and thoroughly up-to-date. Contains over 4,000 Examination Questions with their Answers, 825 pages, 437 illustrations and three folding plates. 25th Revised Edition. Price . . . . . \$2.50

### APPLICATION OF HIGHLY SUPERHEATED STEAM TO LOCOMOTIVES. By ROBERT GARBE.

A practical book which cannot be recommended too highly to those motive-power men who are anxious to maintain the highest efficiency in their locomotives. Contains special chapters on Generation of Highly Superheated Steam; Superheated Steam and the Two-Cylinder Simple Engine; Compounding and Superheating; Designs of Locomotive Superheaters; Constructive Details of Locomotives Using Highly Superheated Steam. Experimental and Working Results. Illustrated with folding plates and tables. Cloth. Price . . . . . \$3.00

### PRACTICAL INSTRUCTOR AND REFERENCE BOOK FOR LOCOMOTIVE FIREMEN AND ENGINEERS. By CHAS. F. LOCKHART.

An entirely new book on the Locomotive. It appeals to every railroad man, as it tells him how things are done and the right way to do them. Written by a man who has had years of practical experience in locomotive shops and on the road firing and running. The information given in this book cannot be found in any other similar treatise. Eight hundred and fifty-one questions with their answers are included, which will prove specially helpful to those preparing for examination. Practical information on: The Construction and Operation of Locomotives; Breakdowns and their Remedies; Air Brakes and Valve Gears. Rules and Signals are handled in a thorough manner. As a book of reference it cannot be excelled. The book is divided into six parts, as follows: 1. The Fireman's Duties. 2. General Description of the Locomotive. 3. Breakdowns and their Remedies. 4. Air Brakes. 5. Extracts from Standard Rules. 6. Questions for Examination. The 851 questions have been carefully selected and arranged. These cover the examinations required by the different railroads. 368 pages. 88 illustrations. Price . . . . . \$2.00

### PREVENTION OF RAILROAD ACCIDENTS, OR SAFETY IN RAILROADING. By GEORGE BRADSHAW.

This book is a heart-to-heart talk with Railroad Employees, dealing with facts, not theories, and showing the men in the ranks, from every-day experience, how accidents occur and how they may be avoided. The book is illustrated with seventy original photographs and drawings showing the safe and unsafe methods of work. No visionary schemes, no ideal pictures. Just plain facts and Practical Suggestions are given. Every railroad employee who reads the book is a better and safer man to have in railroad service. It gives just the information which will be the means of preventing many injuries and deaths. All railroad employees should procure a copy; read it, and do your part in preventing accidents. 169 pages. Pocket size. Fully illustrated. Price . . . . . 50 cents

### TRAIN RULE EXAMINATIONS MADE EASY. By G. E. COLLINGWOOD.

This is the only practical work on train rules in print. Every detail is covered, and puzzling points are explained in simple, comprehensive language, making it a practical treatise for the Train Dispatcher, Engineman, Trainman, and all others who have to do with the movements of trains. Contains complete and reliable information of the Standard Code of Train Rules for single track. Shows Signals in Colors, as used on the different roads. Explains fully the practical application of train orders, giving a clear and definite understanding of all orders which may be used. The meaning and necessity for certain rules are explained in such a manner that the student may know beyond a doubt the rights conferred under any orders he may receive or the action required by certain rules. As nearly all roads require trainmen to pass regular examinations, a complete set of examination questions, with their answers, are included.

## CATALOGUE OF GOOD, PRACTICAL BOOKS

---

---

These will enable the student to pass the required examinations with credit to himself and the road for which he works. 256 pages. Fully illustrated with Train Signals in Colors. Price . . . . . \$1.50

### THE WALSCHAERT AND OTHER MODERN RADIAL VALVE GEARS FOR LOCOMOTIVES. By Wm. W. Wood.

If you would thoroughly understand the Walschaert Valve Gear you should possess a copy of this book, as the author takes the plainest form of a steam engine—a stationary engine in the rough, that will only turn its crank in one direction—and from it builds up—with the reader's help—a modern locomotive equipped with the Walschaert Valve Gear, complete. The points discussed are clearly illustrated; two large folding plates that show the positions of the valves of both inside or outside admission type, as well as the links and other parts of the gear when the crank is at nine different points in its revolution, are especially valuable in making the movement clear. These employ sliding cardboard models which are contained in a pocket in the cover.

The book is divided into five general divisions, as follows: 1. Analysis of the gear. 2. Designing and erecting the gear. 3. Advantages of the gear. 4. Questions and answers relating to the Walschaert Valve Gear. 5. Setting valves with the Walschaert Valve Gear; the three primary types of locomotive valve motion; modern radial valve gears other than the Walschaert; the Hobart All-free Valve and Valve Gear, with questions and answers on breakdowns; the Baker-Pilliod Valve Gear; the Improved Baker-Pilliod Valve Gear, with questions and answers on breakdowns.

The questions with full answers given will be especially valuable to firemen and engineers in preparing for an examination for promotion. 245 pages. Fourth Revised 1920 Edition. Price . . . . . \$2.50

### WESTINGHOUSE E-T AIR-BRAKE INSTRUCTION POCKET BOOK. By Wm. W. Wood, Air-Brake Instructor.

Here is a book for the railroad man, and the man who aims to be one. It is without doubt the only complete work published on the Westinghouse E-T Locomotive Brake Equipment. Written by an Air-Brake Instructor who knows just what is needed. It covers the subject thoroughly. Everything about the New Westinghouse Engine and Tender Brake Equipment, including the standard No. 5 and the Perfected No. 6 style of brake, is treated in detail. Written in plain English and profusely illustrated with Colored Plates, which enable one to trace the flow of pressures throughout the entire equipment. The best book ever published on the Air Brake. Equally good for the beginner and the advanced engineer. Will pass any one through any examination. It informs and enlightens you on every point. Indispensable to every engineman and trainman.

Contains examination questions and answers on the E-T equipment. Covering what the E-T Brake is. How it should be operated. What to do when defective. Not a question can be asked of the engineman up for promotion, on either the No. 5 or the No. 6 E-T equipment, that is not asked and answered in the book. If you want to thoroughly understand the E-T equipment get a copy of this book. It covers every detail. Makes Air-Brake troubles and examinations easy. Second Revised and Enlarged Edition, 1920. Price . . . . . \$2.50

## MACHINE-SHOP PRACTICE

---

---

### AMERICAN TOOL MAKING AND INTERCHANGEABLE MANUFACTURING. By J. V. Woodworth.

A "shoppy" book, containing no theorizing, no problematical or experimental devices, there are no badly proportioned and impossible diagrams, no catalogue cuts, but a valuable collection of drawings and descriptions of devices, the rich fruits of the author's own experience. In its 500-odd pages the one subject only, Tool Making, and whatever relates thereto, is dealt with. The work stands without a rival. It is a complete practical treatise on the art of American Tool Making and system of interchangeable manufacturing as carried on to-day in the United States. In it are described and illustrated all of the different types and classes of small tools, fixtures, devices, and special appliances which are in general use in all machine-manufacturing and metal-working establishments where economy, capacity, and interchangeability in the production of machined metal parts are imperative. The science of jig making is exhaustively discussed, and particular attention is paid to drill jigs, boring, profiling and milling

## CATALOGUE OF GOOD, PRACTICAL BOOKS

fixtures and other devices in which the parts to be machined are located and fastened within the contrivances. All of the tools, fixtures, and devices illustrated and described have been or are used for the actual production of work, such as parts of drill presses, lathes, patented machinery, typewriters, electrical apparatus, mechanical appliances, brass goods, composition parts, mould products, sheet metal articles, drop-forgings, jewelry, watches, medals, coins, etc. 531 pages. Price . . . . . \$4.50

### MACHINE-SHOP ARITHMETIC. By COLVIN-CHENEY.

This is an arithmetic of the things you have to do with daily. It tells you plainly about: how to find areas in figures; how to find surface or volume of balls or spheres; handy ways for calculating; about compound gearing; cutting screw threads on any lathe; drilling for taps; speeds of drills; taps, emery wheels, grindstones, milling cutters, etc.; all about the Metric system with conversion tables; properties of metals; strength of bolts and nuts; decimal equivalent of an inch. All sorts of machine-shop figuring and 1,001 other things, any one of which ought to be worth more than the price of this book to you, and it saves you the trouble of bothering the boss. 6th edition. 131 pages. Price . . . . . 75 cents

### MODERN MACHINE-SHOP CONSTRUCTION, EQUIPMENT AND MANAGEMENT. By OSCAR E. PERRIGO.

The only work published that describes the Modern Shop or Manufacturing Plant from the time the grass is growing on the site intended for it until the finished product is shipped. Just the book needed by those contemplating the erection of modern shop buildings, the rebuilding and reorganization of old ones, or the introduction of Modern Shop Methods, time and cost systems. It is a book written and illustrated by a practical shop man for practical shop men who are too busy to read theories and want facts. It is the most complete all-round book of its kind ever published. 400 large quarto pages. 225 original and specially-made illustrations. 2d Revised and Enlarged Edition. Price . . . . . \$5.00

### "SHOP KINKS." By ROBERT GRIMSHAW.

A book of 400 pages and 222 illustrations, being entirely different from any other book on machine-shop practice. Departing from conventional style, the author avoids universal or common shop usage and limits his work to showing special ways of doing things better, more cheaply and more rapidly than usual. As a result the advanced methods of representative establishments of the world are placed at the disposal of the reader. This book shows the proprietor where large savings are possible, and how products may be improved. To the employee it holds out suggestions that, properly applied, will hasten his advancement. No shop can afford to be without it. It bristles with valuable wrinkles and helpful suggestions. It will benefit all, from apprentice to proprietor. Every machinist, at any age, should study its pages. Fifth edition. Price . . . . . \$3.00

### THREADS AND THREAD CUTTING. By COLVIN and STABEL.

This clears up many of the mysteries of thread-cutting, such as double and triple threads, internal threads, catching threads, use of hobs, etc. Contains a lot of useful hints and several tables. Third edition. Price . . . . . 35 cents

### EVERYDAY ENGINEERING—THE BEST MECHANICAL MAGAZINE ON THE MARKET. ONLY TWO DOLLARS A YEAR FOR TWELVE NUMBERS. SUBSCRIBE TO-DAY.

Every practical man needs a magazine which will tell him how to make and do things. A monthly magazine devoted to practical mechanics for every-day men. Its aim is to popularize engineering as a science, teaching the elements of applied mechanics and electricity in a straightforward and understandable manner. The magazine maintains its own experimental laboratory, where the devices described in articles submitted to the Editor are first tried out and tested before they are published. This important innovation places the standard of the published material very high, and it insures accuracy and dependability.

The magazine is the only one in this country that specializes in practical model building. Articles in past issues have given comprehensive designs for many model boats, including submarines and chasers, model steam and gasoline engines, electric motors and generators, etc., etc. This feature is a permanent one in the magazine.



---

---

## CATALOGUE OF GOOD, PRACTICAL BOOKS

---

---

Another popular department is that devoted to automobiles and airplanes. Care, maintenance, and operation receive full and authoritative treatment. Every article is written from the practical, every-day man standpoint, rather than from that of the professional.

The magazine entertains while it instructs. It is a journal of practical, dependable information, given in a style that it may be readily assimilated and applied by the man with little or no technical training. The aim is to place before the man who leans toward practical mechanics a series of concise, crisp, readable talks on what is going on and how it is done. These articles are profusely illustrated with clear, snappy photographs, specially posed to illustrate the subject in the magazine's own studio by its own staff of technically-trained illustrators and editors.

The subscription price of the magazine is \$2.00 per year of twelve numbers. Sample copy sent on receipt of twenty cents.

Enter your subscription to this practical magazine with us.

---

---

## THE WHOLE FIELD OF MECHANICAL MOVEMENTS COVERED BY MR. HISCOX'S TWO BOOKS

---

---

*We publish two books by Gardner D. Hiscox that will keep you from "inventing" things that have been done before, and suggest ways of doing things that you have not thought of before. Many a man spends time and money, pondering over some mechanical problem, only to learn, after he has solved the problem, that the same thing has been accomplished and put in practice by others long before. Time and money spent in an effort to accomplish what has already been accomplished are time and money LOST. The whole field of mechanics, every known mechanical movement, and practically every device is covered by these two books. If the thing you want has been invented, it is illustrated in them. If it hasn't been invented, then you'll find in them the nearest things to what you want, some movements or devices that will apply in your case, perhaps; or which will give you a key from which to work. No book or set of books ever published is of more real value to the Inventor, Draftsman, or practical Mechanic than the two volumes described below.*

### MECHANICAL MOVEMENTS, POWERS, AND DEVICES. By GARDNER D. HISCOX.

This is a collection of 1,890 engravings of different mechanical motions and appliances, accompanied by appropriate text, making it a book of great value to the inventor, the draftsman, and to all readers with mechanical tastes. The book is divided into eighteen sections or chapters, in which the subject-matter is classified under the following heads: Mechanical Powers; Transmission of Power; Measurement of Power; Steam Power; Air Power Appliances; Electric Power and Construction; Navigation and Roads; Gearing; Motion and Devices; Controlling Motion; Horological; Mining; Mill and Factory Appliances; Construction and Devices; Drafting Devices; Miscellaneous Devices, etc. 15th edition enlarged. 400 octavo pages. Price . \$4.00

### MECHANICAL APPLIANCES, MECHANICAL MOVEMENTS AND NOVELTIES OF CONSTRUCTION. By GARDNER D. HISCOX.

This is a supplementary volume to the one upon mechanical movements. Unlike the first volume, which is more elementary in character, this volume contains illustrations and descriptions of many combinations of motions and of mechanical devices and appliances found in different lines of machinery, each device being shown by a line drawing with a description showing its working parts and the method of operation. From the multitude of devices described and illustrated might be mentioned, in passing, such items as conveyors and elevators, Prony brakes, thermometers, various types of boilers, solar engines, oil-fuel burners, condensers, evaporators, Corliss and other valve gears, governors, gas engines, water motors of various descriptions, airships, motors and dynamos, automobile and motor bicycles, railway lock signals, car couplers, link and gear motions, ball bearings, breech block mechanism for heavy guns, and a large accumulation of others of equal importance. 1,000 specially made engravings. 396 octavo pages. 4th Edition enlarged. Price . . . . . \$4.00

## CATALOGUE OF GOOD, PRACTICAL BOOKS

### MACHINE-SHOP TOOLS AND SHOP PRACTICE. By W. H. VANDERVOORT.

A work of 555 pages and 673 illustrations, describing in every detail the construction, operation, and manipulation of both hand and machine tools. Includes chapters on filing, fitting, and scraping surfaces; on drills, reamers, taps, and dies; the lathe and its tools; planers, shapers, and their tools; milling machines and cutters; gear cutters and gear cutting; drilling machines and drill work; grinding machines and their work; hardening and tempering; gearing, belting, and transmission machinery; useful data and tables. 6th edition. Price . . . . . \$4.50

### COMPLETE PRACTICAL MACHINIST. By JOSHUA ROSE.

The new, twentieth revised and enlarged edition is now ready. This is one of the best-known books on machine-shop work, and written for the practical workman in the language of the workshop. It gives full, practical instructions on the use of all kinds of metal-working tools, both hand and machine, and tells how the work should be properly done. It covers lathe work, vise work, drills and drilling, taps and dies, hardening and tempering, the making and use of tools, tool grinding, marking out work, machine tools, etc. No machinist's library is complete without this volume. 547 pages, 432 illustrations. 1920. Price . . . . . \$3.00

### HENLEY'S ENCYCLOPEDIA OF PRACTICAL ENGINEERING AND ALLIED TRADES. Edited by JOSEPH G. HORNER, A.M.I.Mech.E.

This book covers the entire practice of Civil and Mechanical Engineering. The best known experts in all branches of engineering have contributed to these volumes. The Cyclopdia is admirably well adapted to the needs of the beginner and the self-taught practical man, as well as the mechanical engineer, designer, draftsman, shop superintendent, foreman and machinist.

It is a modern treatise in five volumes. Handsomely bound in half morocco, each volume containing nearly 500 pages, with thousands of illustrations, including diagrammatic and sectional drawings with full explanatory details. For the complete set of five volumes. Price . . . . . \$30.00

### MODEL MAKING Including Workshop Practice, Design and Construction of Models. Edited by RAYMOND F. YATES. Editor of "Everyday Engineering Magazine."

This book does not describe the construction of toys. Its pages are devoted to model engineering and the mechanical sciences associated with it. It contains descriptions with illustrations of the complete models made by some of the leading model engineers in this country. It is the only book published on this important subject.

The first part of the book is devoted to the mechanical sciences and processes related to model engineering and mechanics in general. To the inexperienced workman, who wishes to make models but is untrained in the fundamental mechanics, this book will afford all the information necessary. For the experienced mechanic, there are many hints and short cuts that will be found helpful. Few mechanics, no matter how well trained, know how to make their own patterns. Yet a complete treatise on this important craft is given. The same holds true in regard to the intelligent use of abrasives in the home shop. This, too, is completely covered in a way that will not only help the beginner but teach the trained man a few things that he may not have understood before. In short, the fore part of the book will prepare men to more thoroughly understand the processes connected with model making no matter what their standing.

This book will help you to become a better mechanic. It is full of suggestions for those who like to make things, amateur and professional alike. It has been prepared especially for men with mechanical hobbies. Some may be engineers, machinists, jewelers, pattern makers, office clerks or bank presidents. Men from various walks of life have a peculiar interest in model engineering. MODEL MAKING will be a help and an inspiration to such men. It tells them "how-to-do" and "how-to-make" things in simple, understandable terms. Not only this, it is full of good, clear working drawings and photographs of the models and apparatus described. Each model has been constructed and actually works if it is made according to directions. 375 pages. 300 illustrations. Price . . . . . \$3.00

## CATALOGUE OF GOOD, PRACTICAL BOOKS

---

---

### SHOP PRACTICE FOR HOME MECHANICS. By RAYMOND FRANCIS YATES.

A thoroughly practical and helpful treatment prepared especially for those who have had little or no experience in shop work. The introduction is given over to an elementary explanation of the fundamentals of mechanical science. This is followed by several chapters on the use of small tools and mechanical measuring instruments. Elementary and more advanced lathe work is treated in detail and directions given for the construction of a number of useful shop appliances. Drilling and reaming, heat treatment of tool steel, special lathe operations, pattern making, grinding, and grinding operations, home foundry work, etc., make up the rest of the volume. The book omits nothing that will be of use to those who use tools or to those who wish to learn the use of tools. The great number of clear engravings (over 300) add tremendously to the text matter and to the value of the volume as a visual instructor. Octavo, about 350 pages. 309 engravings. Price . . . . . \$3.00

## MARINE ENGINEERING

### THE NAVAL ARCHITECT'S AND SHIPBUILDER'S POCKETBOOK. Of Formulæ, Rules, and Tables and Marine Engineer's and Surveyor's Handy Book of Reference. By CLEMENT MACKROW and LLOYD WOOLLARD.

The eleventh revised and enlarged edition of this most comprehensive work has just been issued. It is absolutely indispensable to all engaged in the Shipbuilding Industry, as it condenses into a compact form all data and formulæ that are ordinarily required. The book is completely up to date, including among other subjects a section on Aeronautics. 750 pages, limp leather binding. Price . . . . . \$6.00

### MARINE ENGINES AND BOILERS—THEIR DESIGN AND CONSTRUCTION. THE STANDARD BOOK. By DR. G. BAUER, LESLIE S. ROBERTSON and S. BRYAN DONKIN.

In the words of Dr. Bauer, the present work owes its origin to an oft felt want of a condensed treatise embodying the theoretical and practical rules used in designing marine engines and boilers. The need of such a work has been felt by most engineers engaged in the construction and working of marine engines, not only by the younger men, but also by those of greater experience. The fact that the original German work was written by the chief engineer of the famous Vulcan Works, Stettin, is in itself a guarantee that this book is in all respects thoroughly up-to-date, and that it embodies all the information which is necessary for the design and construction of the highest types of marine engines and boilers. It may be said that the motive power which Dr. Bauer has placed in the fast German liners that have been turned out of late years from the Stettin Works represent the very best practice in marine engineering of the present day. The work is clearly written, thoroughly systematic, theoretically sound; while the character of the plans, drawings, tables, and statistics is without reproach. The illustrations are careful reproductions from actual working drawings, with some well-executed photographic views of completed engines and boilers. 744 pages. 550 illustrations, and numerous tables. Cloth. Price. \$10.00

### MODERN SUBMARINE CHART.

A cross-section view, showing clearly and distinctly all the interior of a Submarine of the latest type. You get more information from this chart about the construction and operation of a submarine than in any other way. No details omitted—everything is accurate and to scale. It is absolutely correct in every detail, having been approved by naval engineers. All the machinery and devices fitted in a modern Submarine Boat are shown, and to make the engraving more readily understood all the features are shown in operative form, with Officers and Men in the act of performing the duties assigned to them in service conditions. THIS CHART IS REALLY AN ENCYCLOPEDIA OF A SUBMARINE. It is educational and worth many times its cost. Mailed in a tube for . . . . . 25 cents

MANUAL TRAINING

**ECONOMICS OF MANUAL TRAINING.** By LOUIS ROUILLION.

The only book published that gives just the information needed by all interested in Manual Training, regarding Buildings, Equipment, and Supplies. Shows exactly what is needed for all grades of the work from the Kindergarten to the High and Normal School. Gives itemized lists of everything used in Manual Training Work and tells just what it ought to cost. Also shows where to buy supplies, etc. Contains 174 pages, and is fully illustrated. 2d edition. Price . . . . . \$2.00

MINING

**PROSPECTOR'S FIELD-BOOK AND GUIDE.** By H. S. OSBORN.

Ninth edition, revised and enlarged by M. W. von Bernewitz. The last edition of this volume was published in 1910. It and the previous seven editions were suitable for those times. The new ninth (1920) edition will be found suitable for the present time. While the old-time prospector will always be an important factor, the knowledge of and search for the common and rarer minerals is bringing out men who are trained to some degree. In the field they need a handy and suggestive pocket-book containing hints on prospecting—where to search and how to test—couched in simple terms. The chapter on preliminary instructions covers the fundamentals of a study of the earth's crust. Then follow discussions on practical mineralogy, crystallography, the value of the blowpipe in prospecting, surveying, and chemical tests in the field. Separate chapters are given to the precious and base metals, also to the non-metallic minerals. The chapter on the non-ferrous or alloy group of minerals is entirely new, while the section on oil has been expanded. Surficial indications for copper receive full attention. The chapter on gems has been rewritten and matters concerning gemstones used for industrial purposes, such as abrasives, included. A general chapter covers many useful minerals and salts. An important guide and suggestive aid throughout the new book are the many brief descriptions of ore deposits of all minerals occurring in scattered parts of the world. No other prospector's book contains this class of information. In the appendix will be found numbers of useful tables, and a complete glossary of mining and mineralogical terms. The ninth edition of Osborn's PROSPECTOR'S FIELD BOOK AND GUIDE will be found up to date, worth while, and full value for the money asked. Flexible fabrikoid. 375 pages. 57 illustrations. Price . . . . . \$3.00

PATTERN MAKING

**PRACTICAL PATTERN MAKING.** By F. W. BARROWS.

This book, now in its second edition, is a comprehensive and entirely practical treatise on the subject of pattern making, illustrating pattern work in both wood and metal, and with definite instructions on the use of plaster of Paris in the trade. It gives specific and detailed descriptions of the materials used by pattern makers and describes the tools, both those for the bench and the more interesting machine tools; having complete chapters on the Lathe, the Circular Saw, and the Band Saw. It gives many examples of pattern work, each one fully illustrated and explained with much detail. These examples, in their great variety, offer much that will be found of interest to all pattern makers, and especially to the younger ones, who are seeking information on the more advanced branches of their trade.

In this second edition of the work will be found much that is new, even to those who have long practised this exacting trade. In the description of patterns as adapted to the Moulding Machine many difficulties which have long prevented the rapid and economical production of castings are overcome; and this great, new branch of the trade is given much space. Stripping plate and stool plate work and the less expensive vibrator, or rapping plate work, are all explained in detail.

Plain, everyday rules for lessening the cost of patterns, with a complete system of cost keeping, a detailed method of marking, applicable to all branches of the trade,

## CATALOGUE OF GOOD, PRACTICAL BOOKS

---

---

with complete information showing what the pattern is, its specific title, its cost, date of production, material of which it is made, the number of pieces and core-boxes, and its location in the pattern safe, all condensed into a most complete card record, with cross index.

The book closes with an original and practical method for the inventory and valuation of patterns. Containing nearly 350 pages and 170 illustrations. Price . \$2.50

### MOTOR BOATS

**MOTOR BOATS AND BOAT MOTORS.** By VICTOR W. PAGÉ AND A. C. LEITCH.

All who are interested in motor boats, either as owners, builders or repairmen will find this latest work a most comprehensive treatise on the design, construction, operation and repair of motor boats and their power plants. It is really two complete books in one cover as it consists of two parts, each complete in itself. Part One deals with THE HULL AND ITS FITTINGS, Part Two considers THE POWER PLANT AND ITS AUXILIARIES. A valuable feature of this book is the complete set of dimensioned working drawings detailing the construction of five different types of boats ranging from a 16-foot shallow draft, tunnel stern general utility craft to a 25-foot cabin cruiser. These plans are by A. C. Leitch, a practical boat builder and expert naval architect and are complete in every particular. Full instructions are given for the selection of a power plant and its installation in the hull. Valuable advice is included on boat and engine operation and latest designs of motors are described and illustrated. The instructions for overhauling boat and engine are worth many times the small cost of the book. It is a comprehensive work of reference for all interested in motor boating in any of its phases. Octavo. Cloth. 350 illustrations. 500 pages. Price . . . . . \$4.00

### PERFUMERY

**PERFUMES AND COSMETICS, THEIR PREPARATION AND MANUFACTURE.** By G. W. ASKINSON, Perfumer.

A comprehensive treatise, in which there has been nothing omitted that could be of value to the perfumer or manufacturer of toilet preparations. Complete directions for making handkerchief perfumes, smelling-salts, sachets, fumigating pastilles; preparations for the care of the skin, the mouth, the hair, cosmetics, hair dyes and other toilet articles are given, also a detailed description of aromatic substances; their nature, tests of purity, and wholesale manufacture, including a chapter on synthetic products, with formulas for their use. A book of general, as well as professional interest, meeting the wants not only of the druggist and perfume manufacturer, but also of the general public. Among the contents are: 1. The History of Perfumery. 2. About Aromatic Substances in General. 3. Odors from the Vegetable Kingdom. 4. The Aromatic Vegetable Substances Employed in Perfumery. 5. The Animal Substances Used in Perfumery. 6. The Chemical products Used in Perfumery. 7. The Extraction of Odors. 8. The Special Characteristics of Aromatic Substances. 9. The Adulteration of Essential Oils and Their Recognition. 10. Synthetic Products. 11. Table of Physical Properties of Aromatic Chemicals. 12. The Essences of Extracts Employed in Perfumery. 13. Directions for Making the Most Important Essences and Extracts. 14. The Division of Perfumery. 15. The Manufacture of Handkerchief Perfumes. 16. Formulas for Handkerchief Perfumes. 17. Ammoniacal and Acid Perfumes. 18. Dry Perfumes. 19. Formulas for Dry Perfumes. 20. The Perfumes Used for Fumigation. 21. Antiseptic and Therapeutic Value of Perfumes. 22. Classification of Odors. 23. Some Special Perfumery Products. 24. Hygiene and Cosmetic Perfumery. 25. Preparations for the Care of the Skin. 26. Manufacture of Casein. 27. Formulas for Emulsions. 28. Formulas for Cream. 29. Formulas for Meals, Pastes and Vegetable Milk. 30. Preparations Used for the Hair. 31. Formulas for Hair Tonics and Restorers. 32. Pomades and Hair Oils. 33. Formulas for the Manufacture of Pomades and Hair Oils. 34. Hair Dyes and Depilatories. 35. Wax Pomades, Bando-lines and Brilliantines. 36. Skin Cosmetics and Face Lotions. 37. Preparations for the Nails. 38. Water Softeners and Bath Salts. 39. Preparations for the Care of the Mouth. 40. The Colors Used in Perfumery. 41. The Utensils Used in the Toilet,

## CATALOGUE OF GOOD, PRACTICAL BOOKS

---

Fourth edition much enlarged and brought up-to-date. Nearly 400 pages, illustrated. Price . . . . . \$5.00

### WHAT IS SAID OF THIS BOOK:

"The most satisfactory work on the subject of Perfumery that we have ever seen. We feel safe in saying that here is a book on Perfumery that will not disappoint you, for it has practical and excellent formulæ that are within your ability to prepare readily.

"We recommend the volume as worthy of confidence, and say that no purchaser will be disappointed in securing from its pages good value for its cost, and a large dividend on the same, even if he should use but one per cent of its working formulæ. There is money in it for every user of its information."—*Pharmaceutical Record*.

### HENLEY'S TWENTIETH CENTURY BOOK OF RECIPES, FORMULAS AND PROCESSES. Edited by G. D. HISCOX.

The most valuable techno-chemical receipt book published. Contains over 10,000 practical receipts, many of which will prove of special value to the perfumer. Cloth Bound. Price . . . . . \$4.00

## PLUMBING

### MECHANICAL DRAWING FOR PLUMBERS. By R. M. STARBUCK.

A concise, comprehensive and practical treatise on the subject of mechanical drawing in its various modern applications to the work of all who are in any way connected with the plumbing trade. Nothing will so help the plumber in estimating and in explaining work to customers and workmen as a knowledge of drawing, and to the workman it is of inestimable value if he is to rise above his position to positions of greater responsibility. Among the chapters contained are: 1. Value to plumber of knowledge of drawing; tools required and their use; common views needed in mechanical drawing. 2. Perspective versus mechanical drawing in showing plumbing construction. 3. Correct and incorrect methods in plumbing drawing; plan and elevation explained. 4. Floor and cellar plans and elevation; scale drawings; use of triangles. 5. Use of triangles; drawing of fittings, traps, etc. 6. Drawing plumbing elevations and fittings. 7. Instructions in drawing plumbing elevations. 8. The drawing of plumbing fixtures; scale drawings. 9. Drawings of fixtures and fittings. 10. Inking of drawings. 11. Shading of drawings. 12. Shading of drawings. 13. Sectional drawings; drawing of threads. 14. Plumbing elevations from architect's plan. 15. Elevations of separate parts of the plumbing system. 16. Elevations from the architect's plans. 17. Drawings of detail plumbing connections. 18. Architect's plans and plumbing elevations of residence. 19. Plumbing elevations of residence (continued); plumbing plans for cottage. 20. Plumbing elevations; roof connections. 21. Plans and plumbing elevations for six-flat building. 22. Drawing of various parts of the plumbing system; use of scales. 23. Use of architect's scales. 24. Special features in the illustrations of country plumbing. 25. Drawing of wrought-iron piping, valves, radiators, coils, etc. 26. Drawing of piping to illustrate heating systems. 150 illustrations. Price . . . . . \$2.00

### MODERN PLUMBING ILLUSTRATED. By R. M. STARBUCK.

This book represents the highest standard of plumbing work. It has been adopted and used as a reference book by the United States Government, in its sanitary work in Cuba, Porto Rico, and the Philippines, and by the principal Boards of Health of the United States and Canada.

It gives connections, sizes and working data for all fixtures and groups of fixtures. It is helpful to the master plumber in demonstrating to his customers and in figuring work. It gives the mechanic and student quick and easy access to the best modern plumbing practice. Suggestions for estimating plumbing construction are contained in its pages. This book represents, in a word, the latest and best up-to-date practice and should be in the hands of every architect, sanitary engineer and plumber who wishes to keep himself up to the minute on this important feature of construction. Contains following chapters, each illustrated with a full-page plate: Kitchen sink, laundry tubs, vegetable wash sink; lavatories, pantry sinks, contents of marble slabs; bath tub, foot and sitz bath, shower bath; water closets, venting of water closets; low-

## CATALOGUE OF GOOD, PRACTICAL BOOKS

---

---

down water closets, water closets operated by flush valves, water closet range; slop sink, urinals, the bidet; hotel and restaurant sink, grease trap; refrigerators, safe wastes, laundry waste, lines of refrigerators, bar sinks, soda fountain sinks; horse stall, frost-proof water closets; connections for S traps, venting; connections for drum traps; soil pipe connections; supporting of soil pipe; main trap and fresh air inlet; floor drains and cellar drains, subsoil drainage; water closets and floor connections; local venting; connections for bath rooms; connections for bath rooms, continued; connections for bath rooms, continued; connections for bath rooms, continued; examples of poor practice; roughing work ready for test; testing of plumbing system; method of continuous venting; continuous venting for two-floor work; continuous venting for two lines of fixtures on three or more floors; continuous venting of water closets; plumbing for cottage house; construction for cellar piping; plumbing for residence, use of special fittings; plumbing for two-flat house; plumbing for apartment building, plumbing for double apartment building; plumbing for office building; plumbing for public toilet rooms; plumbing for public toilet rooms, continued; plumbing for bath establishment; plumbing for engine house, factory plumbing; automatic flushing for schools, factories, etc.; use of flushing valves; urinals for public toilet rooms; the Durham system, the destruction of pipes by electrolysis; construction of work without use of lead; automatic sewage lift; automatic sump tank; country plumbing; construction of cesspools; septic tank and automatic sewage siphon; country plumbing; water supply for country house; thawing of water mains and service by electricity; double boilers; hot water supply of large buildings; automatic control of hot water tank; suggestion for estimating plumbing construction. 407 octavo pages, fully illustrated by 58 full-page engravings. Third, revised and enlarged edition just issued. Price . \$5.00

### STANDARD PRACTICAL PLUMBING. By R. M. STARBUCK.

A complete practical treatise of 450 pages covering the subject of Modern Plumbing in all its branches, a large amount of space being devoted to a very complete and practical treatment of the subject of Hot Water Supply and Circulation and Range Boiler Work. Its thirty chapters include about every phase of the subject one can think of, making it an indispensable work to the master plumber, the journeyman plumber, and the apprentice plumber, containing chapters on: the plumber's tools; wiping solder; composition and use; joint wiping; lead work; traps; siphonage of traps; venting; continuous venting; house sewer and sewer connections; house drain; soil piping, roughing; main trap and fresh air inlet; floor, yard, cellar drains, rain leaders, etc.; fixture wastes; water closets; ventilation; improved plumbing connections; residence plumbing; plumbing for hotels, schools, factories, stables, etc.; modern country plumbing; filtration of sewage and water supply; hot and cold supply; range boilers; circulation; circulating pipes; range boiler problems; hot water for large buildings; water lift and its use; multiple connections for hot water boilers; heating of radiation by supply system; theory for the plumber; drawing for the plumber. Fully illustrated by 347 engravings. Price . . . . . \$3.50

## RECIPE BOOK

### HENLEY'S TWENTIETH CENTURY BOOK OF RECIPES, FORMULAS AND PROCESSES. Edited by GARDNER D. HISCOX.

The most valuable Techno-chemical Formula Book published, including over 10,000 selected scientific, chemical, technological, and practical recipes and processes.

This is the most complete Book of Formulas ever published, giving thousands of recipes for the manufacture of valuable articles for everyday use. Hints, Helps, Practical Ideas, and Secret Processes are revealed within its pages. It covers every branch of the useful arts and tells thousands of ways of making money, and is just the book everyone should have at his command.

Modern in its treatment of every subject that properly falls within its scope, the book may truthfully be said to present the very latest formulas to be found in the arts and industries, and to retain those processes which long experience has proven worthy of a permanent record. To present here even a limited number of the subjects which find a place in this valuable work would be difficult. Suffice to say that in its pages will be found matter of intense interest and immeasurably practical value to the scientific amateur and to him who wishes to obtain a knowledge of the many processes used in the arts, trades and manufacture, a knowledge which will render his pursuits more instructive and remunerative. Serving as a reference book to the small and large manufacturer and supplying intelligent seekers with the information necessary to

## CATALOGUE OF GOOD, PRACTICAL BOOKS

conduct a process, the work will be found of inestimable worth to the Metallurgist, the Photographer, the Perfumer, the Painter, the Manufacturer of Glues, Pastes, Cements, and Mucilages, the Compounder of Alloys, the Cook, the Physician, the Druggist, the Electrician, the Brewer, the Engineer, the Foundryman, the Machinist, the Potter, the Tanner, the Confectioner, the Chiropodist, the Manicure, the Manufacturer of Chemical Novelties and Toilet Preparations, the Dyer, the Electroplater, the Enameler, the Engraver, the Provisioner, the Glass Worker, the Goldbeater, the Watchmaker, the Jeweler, the Hat Maker, the Ink Manufacturer, the Optician, the Farmer, the Dairyman, the Paper Maker, the Wood and Metal Worker, the Chandler and Soap Maker, the Veterinary Surgeon, and the Technologist in general.

A mine of information, and up-to-date in every respect. A book which will prove of value to EVERYONE, as it covers every branch of the Useful Arts. Every home needs this book; every office, every factory, every store, every public and private enterprise—EVERYWHERE—should have a copy. 800 pages. Cloth Bound.  
Price . . . . . \$4.00

### WHAT IS SAID OF THIS BOOK:

"Your Twentieth Century Book of Recipes, Formulas, and Processes duly received. I am glad to have a copy of it, and if I could not replace it, money couldn't buy it. It is the best thing of the sort I ever saw." (Signed) M. E. TRUX, Sparta, Wis.

"There are few persons who would not be able to find in the book some single formula that would repay several times the cost of the book."—*Merchants' Record and Show Window*.

"I purchased your book 'Henley's Twentieth Century Book of Recipes, Formulas and Processes' about a year ago and it is worth its weight in gold."—WM. H. MURRAY, Bennington, Vt.

### "THE BOOK WORTH THREE HUNDRED DOLLARS"

"On close examination of your 'Twentieth Century Receipt Book,' I find it to be a very valuable and useful book with the very best of practical information obtainable. The price of the book, \$3.00, is very small in comparison to the benefits which one can obtain from it. I consider the book worth fully three hundred dollars to anyone."—DR. A. C. SPETTS, New York.

### "ONE OF THE WORLD'S MOST USEFUL BOOKS"

"Some time ago, I got one of your 'Twentieth Century Books of Formulas' and have made my living from it ever since. I am alone since my husband's death with two small children to care for and am trying so hard to support them. I have customers who take from me Toilet Articles I put up, following directions given in the book, and I have found every one of them to be fine."—MRS. J. H. McMAKEN, West Toledo, Ohio.

## RUBBER

### RUBBER HAND STAMPS AND THE MANIPULATION OF INDIA RUBBER. By T. O'CONNOR SLOANE.

This book gives full details on all points, treating in a concise and simple manner the elements of nearly everything it is necessary to understand for a commencement in any branch of the India Rubber Manufacture. The making of all kinds of Rubber Hand Stamps, Small Articles of India Rubber, U. S. Government Composition, Dating Hand Stamps, the Manipulation of Sheet Rubber, Toy Balloons, India Rubber Solutions, Cements, Blackings, Renovating Varnish, and Treatment for India Rubber Shoes, etc.; the Hektograph Stamp Inks, and Miscellaneous Notes, with a Short Account of the Discovery, Collection and Manufacture of India Rubber, are set forth in a manner designed to be readily understood, the explanations being plain and simple. Including a chapter on Rubber Tire Making and Vulcanizing; also a chapter on the uses of rubber in Surgery and Dentistry. Third revised and enlarged edition. 175 pages. Illustrated . . . . . \$1.25

### HENLEY'S TWENTIETH CENTURY BOOK OF RECIPES, FORMULAS AND PROCESSES. Edited by GARDNER D. HISCOX.

Contains upward of 10,000 practical receipts, including among them formulas on artificial rubber. Cloth Bound. Price . . . . . \$4.00



# CATALOGUE OF GOOD, PRACTICAL BOOKS

---

## SAWS

### **SAW FILING\* AND MANAGEMENT OF SAWS.** By ROBERT GRIMSHAW.

A practical hand-book on filing, gumming, swaging, hammering, and the brazing of band saws, the speed, work, and power to run circular saws, etc. A handy book for those who have charge of saws, or for those mechanics who do their own filing, as it deals with the proper shape and pitches of saw teeth of all kinds and gives many useful hints and rules for gumming, setting, and filing, and is a practical aid to those who use saws for any purpose. Complete tables of proper shape, pitch, and saw teeth as well as sizes and number of teeth of various saws are included. Fourth edition, revised and enlarged. Illustrated. Price . . . . . \$1.50

## STEAM ENGINEERING

### **AMERICAN STATIONARY ENGINEERING.** By W. E. CRANE.

This book begins at the boiler room and takes in the whole power plant. A plain talk on every-day work about engines, boilers, and their accessories. It is not intended to be scientific or mathematical. All formulas are in simple form so that any one understanding plain arithmetic can readily understand any of them. The author has made this the most practical book in print; has given the results of his years of experience, and has included about all that has to do with an engine room or a power plant. You are not left to guess at a single point. You are shown clearly what to expect under the various conditions; how to secure the best results; ways of preventing "shut downs" and repairs; in short, all that goes to make up the requirements of a good engineer, capable of taking charge of a plant. It's plain enough for practical men and yet of value to those high in the profession.

A partial list of contents is: The boiler room, cleaning boilers, firing, feeding; pumps, inspection and repair; chimneys, sizes and cost; piping; mason work; foundations; testing cement; pile driving; engines, slow and high speed; valves; valve setting; Corliss engines, setting valves, single and double eccentric; air pumps and condensers; different types of condensers; water needed; lining up; pounds; pins not square in crosshead or crank; engineers' tools; pistons and piston rings; bearing metal; hardened copper; drip pipes from cylinder jackets; belts, how made, care of; oils; greases; testing lubricants; rules and tables, including steam tables; areas of segments; squares and square roots; cubes and cube root; areas and circumferences of circles. Notes on: Brick work; explosions; pumps; pump valves; heaters, economizers; safety valves; lap, lead, and clearance. Has a complete examination for a license, etc., etc. Second edition. 285 pages. Illustrated. Price . . . . . \$2.50

### **ENGINE RUNNER'S CATECHISM.** By ROBERT GRIMSHAW.

A practical treatise for the stationary engineer, telling how to erect, adjust, and run the principal steam engines in use in the United States. Describing the principal features of various special and well-known makes of engines: Temper Cut-off, Shipping and Receiving Foundations, Erecting and Starting, Valve Setting, Care and Use, Emergencies, Erecting and Adjusting Special Engines.

The questions asked throughout the catechism are plain and to the point, and the answers are given in such simple language as to be readily understood by anyone. All the instructions given are complete and up-to-date; and they are written in a popular style, without any technicalities or mathematical formulæ. The work is of a handy size for the pocket, clearly and well printed, nicely bound, and profusely illustrated.

To young engineers this catechism will be of great value, especially to those who may be preparing to go forward to be examined for certificates of competency; and to engineers generally it will be of no little service, as they will find in this volume more really practical and useful information than is to be found anywhere else within a like compass. 387 pages. Seventh edition. Price . . . . . \$2.00

### **HORSE-POWER CHART.**

Shows the horse-power of any stationary engine without calculation. No matter what the cylinder diameter of stroke, the steam pressure of cut-off, the revolutions, or whether condensing or non-condensing, it's all there. Easy to use, accurate, and saves time and calculations. Especially useful to engineers and designers. 50 cents

## CATALOGUE OF GOOD, PRACTICAL BOOKS

---

---

### MODERN STEAM ENGINEERING IN THEORY AND PRACTICE. By GARDNER D. HISCOX.

This is a complete and practical work issued for Stationary Engineers and Firemen, dealing with the care and management of boilers, engines, pumps, superheated steam, refrigerating machinery, dynamos, motors, elevators, air compressors, and all other branches with which the modern engineer must be familiar. Nearly 200 questions with their answers on steam and electrical engineering, likely to be asked by the Examining Board, are included.

Among the chapters are: Historical: steam and its properties; appliances for the generation of steam; types of boilers; chimney and its work; heat economy of the feed water; steam pumps and their work; incrustation and its work; steam above atmospheric pressure; flow of steam from nozzles; superheated steam and its work; adiabatic expansion of steam; indicator and its work; steam engine proportions; slide valve engines and valve motion; Corliss engine and its valve gear; compound engine and its theory; triple and multiple expansion engine; steam turbine; refrigeration; elevators and their management; cost of power; steam engine troubles; electric power and electric plants. 487 pages. 405 engravings. 3d Edition. . . . \$3.50

### STEAM ENGINE CATECHISM. By ROBERT GRIMSHAW.

This unique volume of 413 pages is not only a catechism on the question and answer principle, but it contains formulas and worked-out answers for all the Steam problems that appertain to the operation and management of the Steam Engine. Illustrations of various valves and valve gear with their principles of operation are given. Thirty-four Tables that are indispensable to every engineer and fireman that wishes to be progressive and is ambitious to become master of his calling are within its pages. It is a most valuable instructor in the service of Steam Engineering. Leading engineers have recommended it as a valuable educator for the beginner as well as a reference book for the engineer. It is thoroughly indexed for every detail. Every essential question on the Steam Engine with its answer is contained in this valuable work. Sixteenth edition. Price . . . . . \$2.00

### STEAM ENGINEER'S ARITHMETIC. By COLVIN-CHENEY.

A practical pocket-book for the steam engineer. Shows how to work the problems of the engine room and shows "why." Tells how to figure horsepower of engines and boilers; area of boilers; has tables of areas and circumferences; steam tables; has a dictionary of engineering terms. Puts you on to all of the little kinks in figuring whatever there is to figure around a power plant. Tells you about the heat unit; absolute zero; adiabatic expansion; duty of engines; factor of safety; and a thousand and one other things; and everything is plain and simple—not the hardest way to figure, but the easiest. Second Edition. . . . . 75 cents

### STEAM ENGINE TROUBLES. By H. HAMKENS.

It is safe to say that no book has ever been published which gives the practical engineer such valuable and comprehensive information on steam engine design and troubles. There are descriptions of cylinders, valves, pistons, frames, pillow blocks and other bearings, connecting rods, wristplates, dashpots, reachrods, valve gears, governors, piping, throttle, and emergency valves, safety stops, flywheels, oilers, etc. If there is any trouble with these parts, the book gives you the reasons and tells how to remedy them. 350 pages. 276 illustrations. Price . . . . \$2.50

### BOILER ROOM CHART. By GEO. L. FOWLER.

A chart—size 14 x 28 inches—showing in isometric perspective the mechanism belonging in a modern boiler room. The various parts are shown broken or removed, so that the internal construction is fully illustrated. Each part is given a reference number, and these, with the corresponding name, are given in a glossary printed at the sides. Price . . . . . 25 cents

## STEAM HEATING AND VENTILATION

---

---

### PRACTICAL STEAM, HOT-WATER HEATING AND VENTILATION. By A. G. KING.

This book is the standard and latest work published on the subject and has been prepared for the use of all engaged in the business of steam, hot-water heating, and ventilation. It is an original and exhaustive work. Tells how to get heating contracts, how to install heating and ventilating apparatus, the best business methods to be used,

## CATALOGUE OF GOOD, PRACTICAL BOOKS

---

---

with "Tricks of the Trade" for shop use. Rules and data for estimating radiation and cost and such tables and information as make it an indispensable work for everyone interested in steam, hot-water heating, and ventilation. It describes all the principal systems of steam, hot-water, vacuum, vapor, and vacuum-vapor heating, together with the new accelerated systems of hot-water circulation, including chapters on up-to-date methods of ventilation and the fan or blower system of heating and ventilation. Containing chapters on: I. Introduction. II. Heat. III. Evolution of artificial heating apparatus. IV. Boiler surface and settings. V. The chimney flue. VI. Pipe and fittings. VII. Valves, various kinds. VIII. Forms of radiating surfaces. IX. Locating of radiating surfaces. X. Estimating radiation. XI. Steam-heating apparatus. XII. Exhaust-steam heating. XIII. Hot-water heating. XIV. Pressure systems of hot-water work. XV. Hot-water appliances. XVI. Greenhouse heating. XVII. Vacuum vapor and vacuum exhaust heating. XVIII. Miscellaneous heating. XIX. Radiator and pipe connections. XX. Ventilation. XXI. Mechanical ventilation and hot-blast heating. XXII. Steam appliances. XXIII. District heating. XXIV. Pipe and boiler covering. XXV. Temperature regulation and heat control. XXVI. Business methods. XXVII. Miscellaneous. XXVIII. Rules, tables, and useful information. 367 pages. 300 detailed engravings. Second Edition—Revised. Price . . . . . \$3.50

### 500 PLAIN ANSWERS TO DIRECT QUESTIONS ON STEAM, HOT-WATER, VAPOR AND VACUUM HEATING PRACTICE. By ALFRED G. KING.

This work, just off the press, is arranged in question and answer form; it is intended as a guide and text-book for the younger, inexperienced fitter and as a reference book for all fitters. This book tells "how" and also tells "why." No work of its kind has ever been published. It answers all the questions regarding each method or system that would be asked by the steam fitter or heating contractor, and may be used as a text or reference book, and for examination questions by Trade Schools or Steam Fitters' Associations. Rules, data, tables and descriptive methods are given, together with much other detailed information of daily practical use to those engaged in or interested in the various methods of heating. Valuable to those preparing for examinations. Answers every question asked relating to modern Steam, Hot-Water, Vapor and Vacuum Heating. Among the contents are: The Theory and Laws of Heat. Methods of Heating. Chimneys and Flues. Boilers for Heating. Boiler Trimmings and Settings. Radiation. Steam Heating. Boiler, Radiator and Pipe Connections for Steam Heating. Hot Water Heating. The Two-Pipe Gravity System of Hot Water Heating. The Circuit System of Hot Water Heating. The Overhead System of Hot Water Heating. Boiler, Radiator and Pipe Connections for Gravity Systems of Hot Water Heating. Accelerated Hot Water Heating. Expansion Tank Connections. Domestic Hot Water Heating. Valves and Air Valves. Vacuum Vapor and Vacuo-Vapor Heating. Mechanical Systems of Vacuum Heating. Non-Mechanical Vacuum Systems. Vapor Systems. Atmospheric and Modulating Systems. Heating Greenhouses. Information, Rules and Tables. 200 pages, 127 illustrations. Octavo. Cloth. Price . . . . . \$2.00

## STEEL

### STEEL: ITS SELECTION, ANNEALING, HARDENING, AND TEMPERING. By E. R. MARKHAM.

This work was formerly known as "The American Steel Worker," but on the publication of the new, revised edition, the publishers deemed it advisable to change its title to a more suitable one. It is the standard work on Hardening, Tempering, and Annealing Steel of all kinds.

This book tells how to select, and how to work, temper, harden, and anneal steel for everything on earth. It doesn't tell how to temper one class of tools and then leave the treatment of another kind of tool to your imagination and judgment, but it gives careful instructions for every detail of every tool, whether it be a tap, a reamer or just a screw-driver. It tells about the tempering of small watch springs, the hardening of cutlery, and the annealing of dies. In fact, there isn't a thing that a steel worker would want to know that isn't included. It is the standard book on selecting, hardening, and tempering all grades of steel. Among the chapter headings might be mentioned the following subjects: Introduction; the workman; steel; methods of heating;

## CATALOGUE OF GOOD, PRACTICAL BOOKS

---

---

heating tool steel; forging; annealing; hardening baths; baths for hardening; hardening steel; drawing the temper after hardening; examples of hardening; pack hardening; case hardening; spring tempering; making tools of machine steel; special steels; steel for various tools; causes of trouble; high speed steels, etc. 400 pages. Very fully illustrated. Fourth Edition. Price . . . . . **\$3.00**

### **HARDENING, TEMPERING, ANNEALING, AND FORGING OF STEEL.**

By J. V. WOODWORTH.

A new work treating in a clear, concise manner all modern processes for the heating, annealing, forging, welding, hardening, and tempering of steel, making it a book of great practical value to the metal-working mechanic in general, with special directions for the successful hardening and tempering of all steel tools used in the arts, including milling cutters, taps, thread dies, reamers, both solid and shell, hollow mills, punches and dies, and all kinds of sheet metal working tools, shear blades, saws, fine cutlery, and metal cutting tools of all description, as well as for all implements of steel both large and small. In this work the simplest and most satisfactory hardening and tempering processes are given.

The uses to which the leading brands of steel may be adapted are concisely presented, and their treatment for working under different conditions explained, also the special methods for the hardening and tempering of special brands.

A chapter devoted to the different processes for case-hardening is also included, and special reference made to the adaptation of machinery steel for tools of various kinds. Fifth Edition. 322 pages. 215 illustrations. Price . . . . . **\$3.00**

## TRACTORS

### **THE MODERN GAS TRACTOR.** By Major VICTOR W. PAGÉ.

A complete treatise describing all types and sizes of gasoline, kerosene, and oil tractors. Considers design and construction exhaustively, gives complete instructions for care, operation and repair, outlines all practical applications on the road and in the field. The best and latest work on farm tractors and tractor power plants. A work needed by farmers, students, blacksmiths, mechanics, salesmen, implement dealers, designers, and engineers. 500 pages. Nearly 300 illustrations and folding plates. Price **\$3.00**

## TURBINES

### **MARINE STEAM TURBINES.** By DR. G. BAUER and O. LASCHE. Assisted by E. LUDWIG and H. VOGEL. Translated from the German and edited by M. G. S. SWALLOW.

The book is essentially practical and discusses turbines in which the full expansion of steam passes through a number of separate turbines arranged for driving two or more shafts, as in the Parsons system, and turbines in which the complete expansion of steam from inlet to exhaust pressure occurs in a turbine on one shaft, as in the case of the Curtis machines. It will enable a designer to carry out all the ordinary calculation necessary for the construction of steam turbines, hence it fills a want which is hardly met by larger and more theoretical works. Numerous tables, curves and diagrams will be found, which explain with remarkable lucidity the reason why turbine blades are designed as they are, the course which steam takes through turbines of various types, the thermodynamics of steam turbine calculation, the influence of vacuum on steam consumption of steam turbines, etc. In a word, the very information which a designer and builder of steam turbines most requires. Large octavo, 214 pages. Fully illustrated and containing 18 tables, including an entropy chart. Price, net . . . . . **\$4.00**





217

LIBRARY OF CONGRESS



0 013 969 791 1 ●